

# MIKRON *TEC*

MESSZEUGE • TECHNISCHE ENTWICKLUNGEN UND BERATUNG • KALIBRIERLEISTUNGEN



# Inhalt

## Gewinde GLD/GD/AD

Metrische Regelgewinde DIN ISO 13	6
-----------------------------------	---

### *Metrische Feingewinde DIN ISO 13*

Steigung 0.35	7
Steigung 0.5	7
Steigung 0.75	8
Steigung 1	8
Steigung 1.25	9
Steigung 1.5	10
Steigung 2	11
Steigung 3	13
Steigung 4	14
Steigung 6	15

Whitworth Rohrgewinde DIN ISO 228	16
-----------------------------------	----

UNC • Unified Zollgewinde ANSI B1.1 Lehrmaße Gewindedorne ANSI B1.2 Gewinderinge BS 919	17
---	----

UNF • Unified Zollgewinde ANSI B1.1 Lehrenmaße Gewindedorne ANSI B1.2 Gewinderinge BS 919	18
---	----

UNEF • Unified Zollgewinde ANSI B1.1 Lehrenmaße Gewindedorne ANSI B1.2 Gewinderinge BS 919	18
--	----

Stahlpanzerrohrgewinde DIN 40430	20
----------------------------------	----

Elektrogewinde DIN 40400	20
--------------------------	----

Whitworth Rohrgewinde DIN 2999 Gewindegrenzlehrdorne keglig Gewindegrenzlehrringe zylindrisch	21
---	----

Kegeliges Amerikanisches Rohrgewinde NPT Gewindegrenzlehrdorne keglig Gewindegrenzlehrringe keglig	21
--	----

Kegeliges Amerikanisches Rohrgewinde NPTF Gewindegrenzlehrdorne keglig Gewindegrenzlehrringe keglig	22
---	----

## Gewinde AR/GR

Metrisches Regelgewinde DIN ISO 13	23
------------------------------------	----

### *Metrische Feingewinde DIN ISO 13*

Steigung 0.35	24
Steigung 0.5	24
Steigung 0.75	25
Steigung 1	25
Steigung 1.25	26
Steigung 1.5	27
Steigung 2	28
Steigung 3	30
Steigung 4	31
Steigung 6	32

Whitworth Rohrgewinde DIN ISO 228	33
-----------------------------------	----

UNC • Unified Zollgewinde ANSI B1.1 Lehrenmaße Gewindedorne ANSI B1.2 Gewinderinge BS 919	34
---	----

UNF • Unified Zollgewinde ANSI B1.1 Lehrenmaße Gewindedorne ANSI B1.2 Gewinderinge BS 919	35
---	----

UNEF • Unified Zollgewinde ANSI B1.1 Lehrenmaße Gewindedorne ANSI B1.2 Gewinderinge BS 919	35
--	----

Stahlpanzerrohrgewinde DIN 40430	37
----------------------------------	----

Elektrogewinde DIN 40400	37
--------------------------	----

Whitworth Rohrgewinde DIN 2999 Gewindegrenzlehrdorne keglig Gewindegrenzlehrringe zylindrisch	38
---	----

Kegeliges Amerikanisches Rohrgewinde NPT Gewindegrenzlehrdorne keglig Gewindegrenzlehrringe keglig	39
--	----

Kegeliges Amerikanisches Rohrgewinde NPTF Gewindegrenzlehrdorne keglig Gewindegrenzlehrringe keglig	39
---	----

<b>Dorne</b>	
Grenzlehrdorne, LS, ohne ZM, Passung H7 / ohne ZM, andere Passungen / mit ZM	40
Gutlehrdorne, LS, ohne ZM, Passung H7 / ohne ZM, andere Passungen / mit ZM	42
Ausschusslehrdorne, LS, ohne ZM, Passung H7 / ohne ZM, andere Passungen / mit ZM	44
Grenzlehrdorne, GHC, ohne ZM, Passung H7 / ohne ZM, andere Passungen / mit ZM	46
Grenzlehrdorne, HC, ohne ZM, Passung H7 / ohne ZM, andere Passungen / mit ZM	48
Gutlehrdorne, HC, ohne ZM, Passung H7 / ohne ZM, andere Passungen / mit ZM	50
Ausschusslehrdorne, HC, ohne ZM, Passung H7 / ohne ZM, andere Passungen / mit ZM	52
Grenzlehrdorne, GHM, ohne ZM, Passung H7 / ohne ZM, andere Passungen / mit ZM	54
Grenzlehrdorne, HM, ohne ZM, Passung H7 / ohne ZM, andere Passungen / mit ZM	55
Gutlehrdorne, HM, ohne ZM, Passung H7 / ohne ZM, andere Passungen / mit ZM	57
Ausschusslehrdorne, HM, ohne ZM, Passung H7 / ohne ZM, andere Passungen / mit ZM	59
<b>Ringe</b>	
Einstellringe DIN 2250, Form C, ohne ZM / mit ZM	61
Einstellringe DIN 2250, Form B, ohne ZM / mit ZM	65
Gutlehringe DIN 2250, Form C, ohne ZM / mit ZM	68
Ausschusslehringe DIN 2254, Form C, ohne ZM / mit ZM	72
Gutlehringe DIN 2250, Form B, ohne ZM / mit ZM	76

<b>Lehren</b>	
Grenzrachenlehren, doppelmäulig, ohne ZM / mit ZM	79
Grenzrachenlehren, einmäulig, ohne ZM / mit ZM	81
Flache Grenzlochlehren zum Lehren des I-Ø, ohne ZM / mit ZM	84
Flache Gutlochlehren zum Lehren des I-Ø, ohne ZM / mit ZM	86
Flache Ausschusslochlehren zum Lehren des I-Ø, ohne ZM / mit ZM	88
Vierkant-Grenzlehrdorne, A-Seite 2 Messfl., ohne ZM / mit ZM	90
Sechskant-Grenzlehrdorne, A-Seite 2 Messfl., ohne ZM / mit ZM	92
Grenzwellennutenlehren (Nutenlehren), ohne ZM / mit ZM	93
Satzzusammenstellung Gewindelehringe / Gewindelehrdorne	95
<b>Prüfprotokolle</b>	
	96

**Anmerkung:**

*Alle Zeichnungen in dieser Preisliste dienen nur zum Zweck der Veranschaulichung und haben keinerlei Verbindlichkeiten zur entsprechenden DIN.*

## Berechnungsgrundlagen, sonstige Informationen für Gewindelehren

### In Abschnitt Gewindelehren verwendete Abkürzungen:

GLD	Grenzwindelehrdorn
GD	Gutgewindelehrdorn
AD	Ausschussgewindelehrdorn
GR	Gutgewindelehrring
AR	Ausschussgewindelehrring
GLR	Grenzwindelehrring

Artikelgruppen (AGr) mit "L" in der Bezeichnung: Lehren ab Lager lieferbar!

### Standardtoleranzen

Gewindeart	Toleranzfelder		
	GLD	GD / AD	GR / AR
MR und MF DIN ISO 13 bis M 1.4	5H	5H	6h
MR und MF DIN ISO 13 über M 1.4	6H	6H	6g
Whitworth DIN ISO 228	Mittel	Mittel	A
BSW	Mittel	Mittel	Mittel
BSF	Mittel	Mittel	Mittel
Trapezgewinde DIN 103	7H	7H	7e
UNC, UNF, UNEF	2B	2B	2A

### Zuschläge, sonstige Kosten

	Multiplikator	Multiplikator
	Dorne	Ringe
Linksgewinde	x1,5	x1,5
		Kosten
Schmutznut Gewindedorne, Gutseite		15,00 €
Schmutznut Gut-Gewinderingen		15,00 €
SONDER-BESCHRIFTUNG bis 15 Zeichen		2,60 €
SONDER-BESCHRIFTUNG ab 16 Zeichen		4,00 €
SONDER-BESCHRIFTUNG ab 20 Zeichen		5,00 €

### Sonstige Abmessungen, bzw. Toleranzen

auf Anfrage

## Berechnungsgrundlagen, sonstige Informationen für Rundpassungslehren

### In Abschnitt Rundpassungslehren verwendete Abkürzungen:

Z-GLD	Grenzlehrdorn
Z-GD	Gutlehrdorn
Z-AD	Ausschusslehrdorn
Z-ERC	Einstellring, Typ C (für allgemeine Anwendung)
Z-ERB	Einstellring, Typ B (breitere Version, für pneumatische Längenmessgeräte)
Z-GRC	Gutlehring, Typ C (für allgemeine Anwendung)
Z-ARC	Ausschusslehring
Z-GRB	Gutlehring, Typ B (breitere Version, für spezielle Anwendungen)
Z-GRLDM	GrenZRachenlehre, doppelmäulig
Z-GRLEM	GrenZRachenlehre, einmäulig
Z-FGRLL	Flache Grenzlochlehre, für Durchmesserkontrolle
Z-FGLL	Flache Gutlochlehre, für Durchmesserkontrolle
Z-FALL	Flache Ausschusslochlehre, für Durchmesserkontrolle
Z-4KGLD	Vierkant-Grenzlehrdorn
Z-6KGLD	Sechskant-Grenzlehrdorn
Z-GWNL	Grenzwellennutenlehre







Artikelgruppen (AGr) mit "L" in der Bezeichnung: Lehren ab Lager lieferbar!

### Zuschläge, sonstige Kosten, Mengenrabatt

	Multiplikator	Kosten
Edelpassungen (6 und feiner)	auf Anfrage	
Abnahmelehren (ohne "z" auf Gutseite)	auf Anfrage	
Luftnut		15,00 €
SONDER-BESCHRIFTUNG bis 15 Zeichen		2,60 €
SONDER-BESCHRIFTUNG ab 16 Zeichen		4,00 €
SONDER-BESCHRIFTUNG ab 20 Zeichen		5,00 €
Gut-/Ausschussmesszapfen (ohne Griff)		jeweils 50% vom Preis Z-GLD-ZM-...
Mengenrabatt bei Rund-/Flachpassungslehren mit ZM	5% Mengenrabatt ab 3 St. mit gleichem Nennmaß	

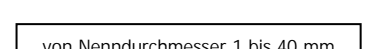
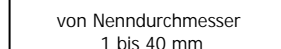
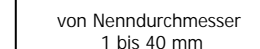
**Für andere, nicht in unserer Preisliste enthaltene Lehrentypen und Abmessungen, erbitten wir Ihre Anfrage!**

per Fax +49 (0) 60 21-78 11 33  
oder per E-Mail [info@mikrontec.de](mailto:info@mikrontec.de)

ANr.	Beschreibung	AGr.	Einzelpreis	ANr.	Beschreibung	AGr.	Einzelpreis	ANr.	Beschreibung	AGr.	Einzelpreis
<b>Grenzwindelehrdorne (GLD)</b>			<b>Gutgewindelehrdorne (GD)</b>			<b>Ausschussgewindelehrdorne (AD)</b>					
											
von Nenndurchmesser 1 bis 40 mm			von Nenndurchmesser 1 bis 40 mm			und über 40 mm					
											
von Nenndurchmesser 1 bis 40 mm			und über 40 mm			von Nenndurchmesser 1 bis 40 mm					
											
von Nenndurchmesser 1 bis 40 mm			und über 40 mm			und über 40 mm					

Metrisches Regelgewinde DIN ISO 13											
0001010550	<b>GLD M 1-5H</b>	150L	<b>123,00 €</b>	0001020550	<b>GD M 1-5H</b>	150	<b>68,00 €</b>	0001030550	<b>AD M 1-5H</b>	150	<b>68,00 €</b>
0001210550	<b>GLD M 1,2-5H</b>	150L	<b>115,00 €</b>	0001220550	<b>GD M 1,2-5H</b>	150	<b>63,00 €</b>	0001230550	<b>AD M 1,2-5H</b>	150	<b>63,00 €</b>
0001410550	<b>GLD M 1,4-5H</b>	150L	<b>93,00 €</b>	0001420550	<b>GD M 1,4-5H</b>	150	<b>51,00 €</b>	0001430550	<b>AD M 1,4-5H</b>	150	<b>51,00 €</b>
0001610050	<b>GLD M 1,6-6H</b>	150L	<b>87,00 €</b>	0001620050	<b>GD M 1,6-6H</b>	150	<b>48,00 €</b>	0001630050	<b>AD M 1,6-6H</b>	150	<b>48,00 €</b>
0001810050	<b>GLD M 1,8-6H</b>	150	<b>83,00 €</b>	0001820050	<b>GD M 1,8-6H</b>	150	<b>45,00 €</b>	0001830050	<b>AD M 1,8-6H</b>	150	<b>45,00 €</b>
0002010050	<b>GLD M 2-6H</b>	150L	<b>76,00 €</b>	0002020050	<b>GD M 2-6H</b>	150	<b>42,00 €</b>	0002030050	<b>AD M 2-6H</b>	150	<b>42,00 €</b>
0002210050	<b>GLD M 2,2-6H</b>	150	<b>78,00 €</b>	0002220050	<b>GD M 2,2-6H</b>	150	<b>43,00 €</b>	0002230050	<b>AD M 2,2-6H</b>	150	<b>43,00 €</b>
0002310050	<b>GLD M 2,3-6H</b>	150	<b>82,00 €</b>	0002320050	<b>GD M 2,3-6H</b>	150	<b>45,00 €</b>	0002330050	<b>AD M 2,3-6H</b>	150	<b>45,00 €</b>
0002510050	<b>GLD M 2,5-6H</b>	150L	<b>58,00 €</b>	0002520050	<b>GD M 2,5-6H</b>	150	<b>32,00 €</b>	0002530050	<b>AD M 2,5-6H</b>	150	<b>32,00 €</b>
0003010050	<b>GLD M 3-6H</b>	150L	<b>58,00 €</b>	0003020050	<b>GD M 3-6H</b>	150	<b>32,00 €</b>	0003030050	<b>AD M 3-6H</b>	150	<b>32,00 €</b>
0003510050	<b>GLD M 3,5-6H</b>	150L	<b>58,00 €</b>	0003520050	<b>GD M 3,5-6H</b>	150	<b>32,00 €</b>	0003530050	<b>AD M 3,5-6H</b>	150	<b>32,00 €</b>
0004010050	<b>GLD M 4-6H</b>	150L	<b>55,00 €</b>	0004020050	<b>GD M 4-6H</b>	150	<b>30,00 €</b>	0004030050	<b>AD M 4-6H</b>	150	<b>30,00 €</b>
0004510050	<b>GLD M 4,5-6H</b>	150	<b>55,00 €</b>	0004520050	<b>GD M 4,5-6H</b>	150	<b>30,00 €</b>	0004530050	<b>AD M 4,5-6H</b>	150	<b>30,00 €</b>
0005010050	<b>GLD M 5-6H</b>	150L	<b>49,00 €</b>	0005020050	<b>GD M 5-6H</b>	150	<b>27,00 €</b>	0005030050	<b>AD M 5-6H</b>	150	<b>27,00 €</b>
0006010050	<b>GLD M 6-6H</b>	150L	<b>54,00 €</b>	0006020050	<b>GD M 6-6H</b>	150	<b>30,00 €</b>	0006030050	<b>AD M 6-6H</b>	150	<b>30,00 €</b>
0007010050	<b>GLD M 7-6H</b>	150	<b>54,00 €</b>	0007020050	<b>GD M 7-6H</b>	150	<b>30,00 €</b>	0007030050	<b>AD M 7-6H</b>	150	<b>30,00 €</b>
0008010050	<b>GLD M 8-6H</b>	150L	<b>54,00 €</b>	0008020050	<b>GD M 8-6H</b>	150	<b>30,00 €</b>	0008030050	<b>AD M 8-6H</b>	150	<b>30,00 €</b>
0009010050	<b>GLD M 9-6H</b>	150	<b>57,00 €</b>	0009020050	<b>GD M 9-6H</b>	150	<b>37,00 €</b>	0009030050	<b>AD M 9-6H</b>	150	<b>31,00 €</b>
0010010050	<b>GLD M 10-6H</b>	150L	<b>57,00 €</b>	0010020050	<b>GD M 10-6H</b>	150	<b>31,00 €</b>	0010030050	<b>AD M 10-6H</b>	150	<b>31,00 €</b>
0011010050	<b>GLD M 11-6H</b>	150	<b>61,00 €</b>	0011020050	<b>GD M 11-6H</b>	150	<b>34,00 €</b>	0011030050	<b>AD M 11-6H</b>	150	<b>34,00 €</b>
0012010050	<b>GLD M 12-6H</b>	150L	<b>61,00 €</b>	0012020050	<b>GD M 12-6H</b>	150	<b>34,00 €</b>	0012030050	<b>AD M 12-6H</b>	150	<b>34,00 €</b>
0014010050	<b>GLD M 14-6H</b>	150L	<b>66,00 €</b>	0014020050	<b>GD M 14-6H</b>	150	<b>37,00 €</b>	0014030050	<b>AD M 14-6H</b>	150	<b>37,00 €</b>
0016010050	<b>GLD M 16-6H</b>	150L	<b>71,00 €</b>	0016020050	<b>GD M 16-6H</b>	150	<b>39,00 €</b>	0016030050	<b>AD M 16-6H</b>	150	<b>39,00 €</b>
0018010050	<b>GLD M 18-6H</b>	150L	<b>77,00 €</b>	0018020050	<b>GD M 18-6H</b>	150	<b>42,00 €</b>	0018030050	<b>AD M 18-6H</b>	150	<b>42,00 €</b>
0020010050	<b>GLD M 20-6H</b>	150L	<b>82,00 €</b>	0020020050	<b>GD M 20-6H</b>	150	<b>45,00 €</b>	0020030050	<b>AD M 20-6H</b>	150	<b>45,00 €</b>
0022010050	<b>GLD M 22-6H</b>	150L	<b>87,00 €</b>	0022020050	<b>GD M 22-6H</b>	150	<b>48,00 €</b>	0022030050	<b>AD M 22-6H</b>	150	<b>48,00 €</b>
0024010050	<b>GLD M 24-6H</b>	150L	<b>98,00 €</b>	0024020050	<b>GD M 24-6H</b>	150	<b>54,00 €</b>	0024030050	<b>AD M 24-6H</b>	150	<b>54,00 €</b>
0027010050	<b>GLD M 27-6H</b>	150L	<b>109,00 €</b>	0027020050	<b>GD M 27-6H</b>	150	<b>60,00 €</b>	0027030050	<b>AD M 27-6H</b>	150	<b>60,00 €</b>
0030010050	<b>GLD M 30-6H</b>	150L	<b>120,00 €</b>	0030020050	<b>GD M 30-6H</b>	150	<b>66,00 €</b>	0030030050	<b>AD M 30-6H</b>	150	<b>66,00 €</b>
0033010050	<b>GLD M 33-6H</b>	150L	<b>130,00 €</b>	0033020050	<b>GD M 33-6H</b>	150	<b>71,00 €</b>	0033030050	<b>AD M 33-6H</b>	150	<b>85,70 €</b>
0036010050	<b>GLD M 36-6H</b>	150L	<b>141,00 €</b>	0036020050	<b>GD M 36-6H</b>	150	<b>78,00 €</b>	0036030050	<b>AD M 36-6H</b>	150	<b>78,00 €</b>
0039010050	<b>GLD M 39-6H</b>	150L	<b>155,00 €</b>	0039020050	<b>GD M 39-6H</b>	150	<b>85,00 €</b>	0039030050	<b>AD M 39-6H</b>	150	<b>85,00 €</b>

Anr.	Beschreibung	AGr.	Einzelpreis	Anr.	Beschreibung	AGr.	Einzelpreis	Anr.	Beschreibung	AGr.	Einzelpreis
<b>Metrisches Regelgewinde DIN ISO 13</b>											
				0042020051	<b>GD M 42-6H</b>	151L	<b>88,00 €</b>	0042030051	<b>AD M 42-6H</b>	151L	<b>88,00 €</b>
				0045020051	<b>GD M 45-6H</b>	151L	<b>95,00 €</b>	0045030051	<b>AD M 45-6H</b>	151L	<b>95,00 €</b>
				0048020051	<b>GD M 48-6H</b>	151L	<b>104,00 €</b>	0048030051	<b>AD M 48-6H</b>	151L	<b>104,00 €</b>
				0052020051	<b>GD M 52-6H</b>	151	<b>110,00 €</b>	0052030051	<b>AD M 52-6H</b>	151	<b>110,00 €</b>
				0056020051	<b>GD M 56-6H</b>	151	<b>122,00 €</b>	0056030051	<b>AD M 56-6H</b>	151	<b>122,00 €</b>
				0060020051	<b>GD M 60-6H</b>	151	<b>130,00 €</b>	0060030051	<b>AD M 60-6H</b>	151	<b>130,00 €</b>
				0064020051	<b>GD M 64-6H</b>	151	<b>142,00 €</b>	0064030051	<b>AD M 64-6H</b>	151	<b>142,00 €</b>
				0068020051	<b>GD M 68-6H</b>	151	<b>151,00 €</b>	0068030051	<b>AD M 68-6H</b>	151	<b>151,00 €</b>

<b>Metrisches Feingewinde DIN ISO 13 - Steigung 0.35</b>											
0302010050	<b>GLD M 2X0,35-6H</b>	150	<b>149,00 €</b>	0302020050	<b>GD M 2X0,35-6H</b>	150	<b>82,00 €</b>	0302030050	<b>AD M 2X0,35-6H</b>	150	<b>82,00 €</b>
0302210050	<b>GLD M 2,2X0,35-6H</b>	150	<b>142,00 €</b>	0302220050	<b>GD M 2,2X0,35-6H</b>	150	<b>78,00 €</b>	0302230050	<b>AD M 2,2X0,35-6H</b>	150	<b>78,00 €</b>
0302510050	<b>GLD M 2,5X0,35-6H</b>	150	<b>111,00 €</b>	0302520050	<b>GD M 2,5X0,35-6H</b>	150	<b>61,00 €</b>	0302530050	<b>AD M 2,5X0,35-6H</b>	150	<b>61,00 €</b>
0303010050	<b>GLD M 3X0,35-6H</b>	150	<b>102,00 €</b>	0303020050	<b>GD M 3X0,35-6H</b>	150	<b>56,00 €</b>	0303030050	<b>AD M 3X0,35-6H</b>	150	<b>56,00 €</b>
0303510050	<b>GLD M 3,5X0,35-6H</b>	150	<b>98,00 €</b>	0303520050	<b>GD M 3,5X0,35-6H</b>	150	<b>54,00 €</b>	0303530050	<b>AD M 3,5X0,35-6H</b>	150	<b>54,00 €</b>
0304010050	<b>GLD M 4X0,35-6H</b>	150	<b>96,00 €</b>	0304020050	<b>GD M 4X0,35-6H</b>	150	<b>53,00 €</b>	0304030050	<b>AD M 4X0,35-6H</b>	150	<b>53,00 €</b>
0304510050	<b>GLD M 4,5X0,35-6H</b>	150	<b>114,00 €</b>	0304520050	<b>GD M 4,5X0,35-6H</b>	150	<b>62,00 €</b>	0304530050	<b>AD M 4,5X0,35-6H</b>	150	<b>62,00 €</b>
0305010050	<b>GLD M 5X0,35-6H</b>	150	<b>110,00 €</b>	0305020050	<b>GD M 5X0,35-6H</b>	150	<b>60,00 €</b>	0305030050	<b>AD M 5X0,35-6H</b>	150	<b>60,00 €</b>
0306010050	<b>GLD M 6X0,35-6H</b>	150	<b>107,00 €</b>	0306020050	<b>GD M 6X0,35-6H</b>	150	<b>59,00 €</b>	0306030050	<b>AD M 6X0,35-6H</b>	150	<b>59,00 €</b>
0307010050	<b>GLD M 7X0,35-6H</b>	150	<b>109,00 €</b>	0307020050	<b>GD M 7X0,35-6H</b>	150	<b>60,00 €</b>	0307030050	<b>AD M 7X0,35-6H</b>	150	<b>60,00 €</b>
0308010050	<b>GLD M 8X0,35-6H</b>	150	<b>110,00 €</b>	0308020050	<b>GD M 8X0,35-6H</b>	150	<b>61,00 €</b>	0308030050	<b>AD M 8X0,35-6H</b>	150	<b>61,00 €</b>
0309010050	<b>GLD M 9X0,35-6H</b>	150	<b>113,00 €</b>	0309020050	<b>GD M 9X0,35-6H</b>	150	<b>62,00 €</b>	0309030050	<b>AD M 9X0,35-6H</b>	150	<b>62,00 €</b>
0310010050	<b>GLD M 10X0,35-6H</b>	150	<b>117,00 €</b>	0310020050	<b>GD M 10X0,35-6H</b>	150	<b>64,00 €</b>	0310030050	<b>AD M 10X0,35-6H</b>	150	<b>64,00 €</b>

<b>Metrisches Feingewinde DIN ISO 13 - Steigung 0.5</b>											
0503510050	<b>GLD M 3,5X0,5-6H</b>	150	<b>117,00 €</b>	0503520050	<b>GD M 3,5X0,5-6H</b>	150	<b>65,00 €</b>	0503530050	<b>AD M 3,5X0,5-6H</b>	150	<b>65,00 €</b>
0504010050	<b>GLD M 4X0,5-6H</b>	150	<b>89,00 €</b>	0504020050	<b>GD M 4X0,5-6H</b>	150	<b>49,00 €</b>	0504030050	<b>AD M 4X0,5-6H</b>	150	<b>49,00 €</b>
0504510050	<b>GLD M 4,5X0,5-6H</b>	150	<b>94,00 €</b>	0504520050	<b>GD M 4,5X0,5-6H</b>	150	<b>52,00 €</b>	0504530050	<b>AD M 4,5X0,5-6H</b>	150	<b>52,00 €</b>
0505010050	<b>GLD M 5X0,5-6H</b>	150	<b>84,00 €</b>	0505020050	<b>GD M 5X0,5-6H</b>	150	<b>46,00 €</b>	0505030050	<b>AD M 5X0,5-6H</b>	150	<b>46,00 €</b>
0506010050	<b>GLD M 6X0,5-6H</b>	150	<b>84,00 €</b>	0506020050	<b>GD M 6X0,5-6H</b>	150	<b>46,00 €</b>	0506030050	<b>AD M 6X0,5-6H</b>	150	<b>46,00 €</b>
0507010050	<b>GLD M 7X0,5-6H</b>	150	<b>84,00 €</b>	0507020050	<b>GD M 7X0,5-6H</b>	150	<b>46,00 €</b>	0507030050	<b>AD M 7X0,5-6H</b>	150	<b>46,00 €</b>
0508010050	<b>GLD M 8X0,5-6H</b>	150L	<b>87,00 €</b>	0508020050	<b>GD M 8X0,5-6H</b>	150	<b>48,00 €</b>	0508030050	<b>AD M 8X0,5-6H</b>	150	<b>48,00 €</b>
0509010050	<b>GLD M 9X0,5-6H</b>	150	<b>93,00 €</b>	0509020050	<b>GD M 9X0,5-6H</b>	150	<b>51,00 €</b>	0509030050	<b>AD M 9X0,5-6H</b>	150	<b>51,00 €</b>
0510010050	<b>GLD M 10X0,5-6H</b>	150L	<b>95,00 €</b>	0510020050	<b>GD M 10X0,5-6H</b>	150	<b>52,00 €</b>	0510030050	<b>AD M 10X0,5-6H</b>	150	<b>52,00 €</b>
0511010050	<b>GLD M 11X0,5-6H</b>	150	<b>107,00 €</b>	0511020050	<b>GD M 11X0,5-6H</b>	150	<b>59,00 €</b>	0511030050	<b>AD M 11X0,5-6H</b>	150	<b>59,00 €</b>
0512010050	<b>GLD M 12X0,5-6H</b>	150	<b>104,00 €</b>	0512020050	<b>GD M 12X0,5-6H</b>	150	<b>57,00 €</b>	0512030050	<b>AD M 12X0,5-6H</b>	150	<b>57,00 €</b>
0513010050	<b>GLD M 13X0,5-6H</b>	150	<b>118,00 €</b>	0513020050	<b>GD M 13X0,5-6H</b>	150	<b>65,00 €</b>	0513030050	<b>AD M 13X0,5-6H</b>	150	<b>65,00 €</b>
0514010050	<b>GLD M 14X0,5-6H</b>	150	<b>113,00 €</b>	0514020050	<b>GD M 14X0,5-6H</b>	150	<b>62,00 €</b>	0514030050	<b>AD M 14X0,5-6H</b>	150	<b>62,00 €</b>
0515010050	<b>GLD M 15X0,5-6H</b>	150	<b>127,00 €</b>	0515020050	<b>GD M 15X0,5-6H</b>	150	<b>70,00 €</b>	0515030050	<b>AD M 15X0,5-6H</b>	150	<b>70,00 €</b>
0516010050	<b>GLD M 16X0,5-6H</b>	150	<b>123,00 €</b>	0516020050	<b>GD M 16X0,5-6H</b>	150	<b>68,00 €</b>	0516030050	<b>AD M 16X0,5-6H</b>	150	<b>68,00 €</b>
0517010050	<b>GLD M 17X0,5-6H</b>	150	<b>141,00 €</b>	0517020050	<b>GD M 17X0,5-6H</b>	150	<b>77,00 €</b>	0517030050	<b>AD M 17X0,5-6H</b>	150	<b>77,00 €</b>
0518010050	<b>GLD M 18X0,5-6H</b>	150	<b>136,00 €</b>	0518020050	<b>GD M 18X0,5-6H</b>	150	<b>75,00 €</b>	0518030050	<b>AD M 18X0,5-6H</b>	150	<b>75,00 €</b>

Anr.	Beschreibung	AGr.	Einzelpreis	Anr.	Beschreibung	AGr.	Einzelpreis	Anr.	Beschreibung	AGr.	Einzelpreis
<b>Metrisches Feingewinde DIN ISO 13 · Steigung 0.5</b>											
0519010050	<b>GLD M 19X0,5-6H</b>	150	<b>153,00 €</b>	0519020050	<b>GD M 19X0,5-6H</b>	150	<b>84,00 €</b>	0519030050	<b>AD M 19X0,5-6H</b>	150	<b>84,00 €</b>
0520010050	<b>GLD M 20X0,5-6H</b>	150	<b>153,00 €</b>	0520020050	<b>GD M 20X0,5-6H</b>	150	<b>84,00 €</b>	0520030050	<b>AD M 20X0,5-6H</b>	150	<b>84,00 €</b>

<b>Metrisches Feingewinde DIN ISO 13 · Steigung 0.75</b>											
0705010050	<b>GLD M 5X0,75-6H</b>	150	<b>67,00 €</b>	0705020050	<b>GD M 5X0,75-6H</b>	150	<b>37,00 €</b>	0705030050	<b>AD M 5X0,75-6H</b>	150	<b>37,00 €</b>
0706010050	<b>GLD M 6X0,75-6H</b>	150	<b>66,00 €</b>	0706020050	<b>GD M 6X0,75-6H</b>	150	<b>36,00 €</b>	0706030050	<b>AD M 6X0,75-6H</b>	150	<b>36,00 €</b>
0707010050	<b>GLD M 7X0,75-6H</b>	150	<b>64,00 €</b>	0707020050	<b>GD M 7X0,75-6H</b>	150	<b>35,00 €</b>	0707030050	<b>AD M 7X0,75-6H</b>	150	<b>35,00 €</b>
0708010050	<b>GLD M 8X0,75-6H</b>	150L	<b>64,00 €</b>	0708020050	<b>GD M 8X0,75-6H</b>	150	<b>35,00 €</b>	0708030050	<b>AD M 8X0,75-6H</b>	150	<b>35,00 €</b>
0709010050	<b>GLD M 9X0,75-6H</b>	150	<b>67,00 €</b>	0709020050	<b>GD M 9X0,75-6H</b>	150	<b>37,00 €</b>	0709030050	<b>AD M 9X0,75-6H</b>	150	<b>37,00 €</b>
0710010050	<b>GLD M 10X0,75-6H</b>	150L	<b>67,00 €</b>	0710020050	<b>GD M 10X0,75-6H</b>	150	<b>37,00 €</b>	0710030050	<b>AD M 10X0,75-6H</b>	150	<b>37,00 €</b>
0711010050	<b>GLD M 11X0,75-6H</b>	150	<b>71,00 €</b>	0711020050	<b>GD M 11X0,75-6H</b>	150	<b>39,00 €</b>	0711030050	<b>AD M 11X0,75-6H</b>	150	<b>39,00 €</b>
0712010050	<b>GLD M 12X0,75-6H</b>	150L	<b>73,00 €</b>	0712020050	<b>GD M 12X0,75-6H</b>	150	<b>40,00 €</b>	0712030050	<b>AD M 12X0,75-6H</b>	150	<b>40,00 €</b>
0713010050	<b>GLD M 13X0,75-6H</b>	150	<b>77,00 €</b>	0713020050	<b>GD M 13X0,75-6H</b>	150	<b>42,00 €</b>	0713030050	<b>AD M 13X0,75-6H</b>	150	<b>42,00 €</b>
0714010050	<b>GLD M 14X0,75-6H</b>	150	<b>79,00 €</b>	0714020050	<b>GD M 14X0,75-6H</b>	150	<b>52,00 €</b>	0714030050	<b>AD M 14X0,75-6H</b>	150	<b>52,00 €</b>
0715010050	<b>GLD M 15X0,75-6H</b>	150	<b>83,00 €</b>	0715020050	<b>GD M 15X0,75-6H</b>	150	<b>46,00 €</b>	0715030050	<b>AD M 15X0,75-6H</b>	150	<b>46,00 €</b>
0716010050	<b>GLD M 16X0,75-6H</b>	150	<b>83,00 €</b>	0716020050	<b>GD M 16X0,75-6H</b>	150	<b>46,00 €</b>	0716030050	<b>AD M 16X0,75-6H</b>	150	<b>46,00 €</b>
0717010050	<b>GLD M 17X0,75-6H</b>	150	<b>88,00 €</b>	0717020050	<b>GD M 17X0,75-6H</b>	150	<b>48,00 €</b>	0717030050	<b>AD M 17X0,75-6H</b>	150	<b>48,00 €</b>
0718010050	<b>GLD M 18X0,75-6H</b>	150	<b>89,00 €</b>	0718020050	<b>GD M 18X0,75-6H</b>	150	<b>49,00 €</b>	0718030050	<b>AD M 18X0,75-6H</b>	150	<b>49,00 €</b>
0719010050	<b>GLD M 19X0,75-6H</b>	150	<b>92,00 €</b>	0719020050	<b>GD M 19X0,75-6H</b>	150	<b>51,00 €</b>	0719030050	<b>AD M 19X0,75-6H</b>	150	<b>51,00 €</b>
0720010050	<b>GLD M 20X0,75-6H</b>	150	<b>95,00 €</b>	0720020050	<b>GD M 20X0,75-6H</b>	150	<b>52,00 €</b>	0720030050	<b>AD M 20X0,75-6H</b>	150	<b>52,00 €</b>
0721010050	<b>GLD M 21X0,75-6H</b>	150	<b>100,00 €</b>	0721020050	<b>GD M 21X0,75-6H</b>	150	<b>55,00 €</b>	0721030050	<b>AD M 21X0,75-6H</b>	150	<b>55,00 €</b>
0722010050	<b>GLD M 22X0,75-6H</b>	150	<b>100,00 €</b>	0722020050	<b>GD M 22X0,75-6H</b>	150	<b>55,00 €</b>	0722030050	<b>AD M 22X0,75-6H</b>	150	<b>55,00 €</b>
0723010050	<b>GLD M 23X0,75-6H</b>	150	<b>111,00 €</b>	0723020050	<b>GD M 23X0,75-6H</b>	150	<b>61,00 €</b>	0723030050	<b>AD M 23X0,75-6H</b>	150	<b>61,00 €</b>
0724010050	<b>GLD M 24X0,75-6H</b>	150	<b>114,00 €</b>	0724020050	<b>GD M 24X0,75-6H</b>	150	<b>63,00 €</b>	0724030050	<b>AD M 24X0,75-6H</b>	150	<b>63,00 €</b>
0725010050	<b>GLD M 25X0,75-6H</b>	150	<b>117,00 €</b>	0725020050	<b>GD M 25X0,75-6H</b>	150	<b>64,00 €</b>	0725030050	<b>AD M 25X0,75-6H</b>	150	<b>64,00 €</b>
0726010050	<b>GLD M 26X0,75-6H</b>	150	<b>124,00 €</b>	0726020050	<b>GD M 26X0,75-6H</b>	150	<b>68,00 €</b>	0726030050	<b>AD M 26X0,75-6H</b>	150	<b>68,00 €</b>
0727010050	<b>GLD M 27X0,75-6H</b>	150	<b>125,00 €</b>	0727020050	<b>GD M 27X0,75-6H</b>	150	<b>69,00 €</b>	0727030050	<b>AD M 27X0,75-6H</b>	150	<b>69,00 €</b>
0728010050	<b>GLD M 28X0,75-6H</b>	150	<b>128,00 €</b>	0728020050	<b>GD M 28X0,75-6H</b>	150	<b>70,00 €</b>	0728030050	<b>AD M 28X0,75-6H</b>	150	<b>70,00 €</b>
0730010050	<b>GLD M 30X0,75-6H</b>	150	<b>139,00 €</b>	0730020050	<b>GD M 30X0,75-6H</b>	150	<b>76,00 €</b>	0730030050	<b>AD M 30X0,75-6H</b>	150	<b>76,00 €</b>

<b>Metrisches Feingewinde DIN ISO 13 · Steigung 1</b>											
1008010050	<b>GLD M 8X1-6H</b>	150L	<b>59,00 €</b>	1008020050	<b>GD M 8X1-6H</b>	150	<b>32,00 €</b>	1008030050	<b>AD M 8X1-6H</b>	150	<b>32,00 €</b>
1009010050	<b>GLD M 9X1-6H</b>	150	<b>61,00 €</b>	1009020050	<b>GD M 9X1-6H</b>	150	<b>34,00 €</b>	1009030050	<b>AD M 9X1-6H</b>	150	<b>34,00 €</b>
1010010050	<b>GLD M 10X1-6H</b>	150L	<b>61,00 €</b>	1010020050	<b>GD M 10X1-6H</b>	150	<b>34,00 €</b>	1010030050	<b>AD M 10X1-6H</b>	150	<b>34,00 €</b>
1011010050	<b>GLD M 11X1-6H</b>	150L	<b>65,00 €</b>	1011020050	<b>GD M 11X1-6H</b>	150	<b>36,00 €</b>	1011030050	<b>AD M 11X1-6H</b>	150	<b>36,00 €</b>
1012010050	<b>GLD M 12X1-6H</b>	150L	<b>65,00 €</b>	1012020050	<b>GD M 12X1-6H</b>	150	<b>36,00 €</b>	1012030050	<b>AD M 12X1-6H</b>	150	<b>36,00 €</b>
1013010050	<b>GLD M 13X1-6H</b>	150	<b>72,00 €</b>	1013020050	<b>GD M 13X1-6H</b>	150	<b>39,00 €</b>	1013030050	<b>AD M 13X1-6H</b>	150	<b>39,00 €</b>
1014010050	<b>GLD M 14X1-6H</b>	150L	<b>71,00 €</b>	1014020050	<b>GD M 14X1-6H</b>	150	<b>39,00 €</b>	1014030050	<b>AD M 14X1-6H</b>	150	<b>39,00 €</b>
1015010050	<b>GLD M 15X1-6H</b>	150	<b>76,00 €</b>	1015020050	<b>GD M 15X1-6H</b>	150	<b>42,00 €</b>	1015030050	<b>AD M 15X1-6H</b>	150	<b>42,00 €</b>
1016010050	<b>GLD M 16X1-6H</b>	150L	<b>76,00 €</b>	1016020050	<b>GD M 16X1-6H</b>	150	<b>42,00 €</b>	1016030050	<b>AD M 16X1-6H</b>	150	<b>42,00 €</b>
1017010050	<b>GLD M 17X1-6H</b>	150	<b>81,00 €</b>	1017020050	<b>GD M 17X1-6H</b>	150	<b>44,00 €</b>	1017030050	<b>AD M 17X1-6H</b>	150	<b>44,00 €</b>
1018010050	<b>GLD M 18X1-6H</b>	150L	<b>79,00 €</b>	1018020050	<b>GD M 18X1-6H</b>	150	<b>43,00 €</b>	1018030050	<b>AD M 18X1-6H</b>	150	<b>43,00 €</b>



Anr.	Beschreibung	AGr.	Einzelpreis	Anr.	Beschreibung	AGr.	Einzelpreis	Anr.	Beschreibung	AGr.	Einzelpreis
<b>Metrisches Feingewinde DIN ISO 13 - Steigung 1</b>											
1019010050	GLD M 19X1-6H	150	86,00 €	1019020050	GD M 19X1-6H	150	47,00 €	1019030050	AD M 19X1-6H	150	47,00 €
1020010050	GLD M 20X1-6H	150L	85,00 €	1020020050	GD M 20X1-6H	150	47,00 €	1020030050	AD M 20X1-6H	150	47,00 €
1021010050	GLD M 21X1-6H	150	92,00 €	1021020050	GD M 21X1-6H	150	50,00 €	1021030050	AD M 21X1-6H	150	50,00 €
1022010050	GLD M 22X1-6H	150	91,00 €	1022020050	GD M 22X1-6H	150	50,00 €	1022030050	AD M 22X1-6H	150	50,00 €
1023010050	GLD M 23X1-6H	150	99,00 €	1023020050	GD M 23X1-6H	150	55,00 €	1023030050	AD M 23X1-6H	150	55,00 €
1024010050	GLD M 24X1-6H	150L	99,00 €	1024020050	GD M 24X1-6H	150	55,00 €	1024030050	AD M 24X1-6H	150	55,00 €
1025010050	GLD M 25X1-6H	150	104,00 €	1025020050	GD M 25X1-6H	150	57,00 €	1025030050	AD M 25X1-6H	150	57,00 €
1026010050	GLD M 26X1-6H	150	106,00 €	1026020050	GD M 26X1-6H	150	58,00 €	1026030050	AD M 26X1-6H	150	58,00 €
1027010050	GLD M 27X1-6H	150	111,00 €	1027020050	GD M 27X1-6H	150	61,00 €	1027030050	AD M 27X1-6H	150	61,00 €
1028010050	GLD M 28X1-6H	150	111,00 €	1028020050	GD M 28X1-6H	150	61,00 €	1028030050	AD M 28X1-6H	150	61,00 €
1030010050	GLD M 30X1-6H	150L	119,00 €	1030020050	GD M 30X1-6H	150	65,00 €	1030030050	AD M 30X1-6H	150	65,00 €
1032010050	GLD M 32X1-6H	150	124,00 €	1032020050	GD M 32X1-6H	150	68,00 €	1032030050	AD M 32X1-6H	150	68,00 €
1033010050	GLD M 33X1-6H	150	128,00 €	1033020050	GD M 33X1-6H	150	70,00 €	1033030050	AD M 33X1-6H	150	70,00 €
1034010050	GLD M 34X1-6H	150	133,00 €	1034020050	GD M 34X1-6H	150	73,00 €	1034030050	AD M 34X1-6H	150	73,00 €
1035010050	GLD M 35X1-6H	150	135,00 €	1035020050	GD M 35X1-6H	150	74,00 €	1035030050	AD M 35X1-6H	150	74,00 €
1036010050	GLD M 36X1-6H	150	138,00 €	1036020050	GD M 36X1-6H	150	76,00 €	1036030050	AD M 36X1-6H	150	76,00 €
1038010050	GLD M 38X1-6H	150	146,00 €	1038020050	GD M 38X1-6H	150	80,00 €	1038030050	AD M 38X1-6H	150	80,00 €
1039010050	GLD M 39X1-6H	150	154,00 €	1039020050	GD M 39X1-6H	150	85,00 €	1039030050	AD M 39X1-6H	150	85,00 €
1040010050	GLD M 40X1-6H	150	154,00 €	1040020050	GD M 40X1-6H	150	85,00 €	1040030050	AD M 40X1-6H	150	85,00 €
				1042020051	GD M 42X1-6H	151	86,00 €	1042030051	AD M 42X1-6H	151	86,00 €
				1045020051	GD M 45X1-6H	151	91,00 €	1045030051	AD M 45X1-6H	151	91,00 €
				1048020051	GD M 48X1-6H	151	98,00 €	1048030051	AD M 48X1-6H	151	98,00 €
				1050020051	GD M 50X1-6H	151	101,00 €	1050030051	AD M 50X1-6H	151	101,00 €
				1052020051	GD M 52X1-6H	151	106,00 €	1052030051	AD M 52X1-6H	151	106,00 €
				1055020051	GD M 55X1-6H	151	111,00 €	1055030051	AD M 55X1-6H	151	111,00 €
				1056020051	GD M 56X1-6H	151	113,00 €	1056030051	AD M 56X1-6H	151	113,00 €
				1058020051	GD M 58X1-6H	151	118,00 €	1058030051	AD M 58X1-6H	151	118,00 €
				1060020051	GD M 60X1-6H	151	123,00 €	1060030051	AD M 60X1-6H	151	123,00 €
				1062020051	GD M 62X1-6H	151	126,00 €	1062030051	AD M 62X1-6H	151	126,00 €
				1064020051	GD M 64X1-6H	151	128,00 €	1064030051	AD M 64X1-6H	151	128,00 €
				1065020051	GD M 65X1-6H	151	131,00 €	1065030051	AD M 65X1-6H	151	131,00 €
				1068020051	GD M 68X1-6H	151	137,00 €	1068030051	AD M 68X1-6H	151	137,00 €
				1070020051	GD M 70X1-6H	151	141,00 €	1070030051	AD M 70X1-6H	151	141,00 €
				1072020051	GD M 72X1-6H	151	145,00 €	1072030051	AD M 72X1-6H	151	145,00 €
				1075020051	GD M 75X1-6H	151	152,00 €	1075030051	AD M 75X1-6H	151	152,00 €
				1076020051	GD M 76X1-6H	151	153,00 €	1076030051	AD M 76X1-6H	151	153,00 €
				1078020051	GD M 78X1-6H	151	157,00 €	1078030051	AD M 78X1-6H	151	157,00 €
				1080020051	GD M 80X1-6H	151	160,00 €	1080030051	AD M 80X1-6H	151	160,00 €
<b>Metrisches Feingewinde DIN ISO 13 - Steigung 1,25</b>											
1210010050	GLD M 10X1,25-6H	150L	70,00 €	1210020050	GD M 10X1,25-6H	150	39,00 €	1210030050	AD M 10X1,25-6H	150	39,00 €
1212010050	GLD M 12X1,25-6H	150L	74,00 €	1212020050	GD M 12X1,25-6H	150	41,00 €	1212030050	AD M 12X1,25-6H	150	41,00 €
1214010050	GLD M 14X1,25-6H	150L	80,00 €	1214020050	GD M 14X1,25-6H	150	44,00 €	1214030050	AD M 14X1,25-6H	150	44,00 €

ANr.	Beschreibung	AGr.	Einzelpreis	ANr.	Beschreibung	AGr.	Einzelpreis	ANr.	Beschreibung	AGr.	Einzelpreis
<b>Metrisches Feingewinde DIN ISO 13 - Steigung 1,5</b>											
1512010050	<b>GLD M 12X1,5-6H</b>	150L	<b>60,00 €</b>	1512020050	<b>GD M 12X1,5-6H</b>	150	<b>33,00 €</b>	1512030050	<b>AD M 12X1,5-6H</b>	150	<b>33,00 €</b>
1513010050	<b>GLD M 13X1,5-6H</b>	150	<b>64,00 €</b>	1513020050	<b>GD M 13x1,5-6H</b>	150	<b>35,00 €</b>	1513030050	<b>AD M 13x1,5-6H</b>	150	<b>35,00 €</b>
1514010050	<b>GLD M 14X1,5-6H</b>	150L	<b>64,00 €</b>	1514020050	<b>GD M 14X1,5-6H</b>	150	<b>35,00 €</b>	1514030050	<b>AD M 14X1,5-6H</b>	150	<b>35,00 €</b>
1515010050	<b>GLD M 15X1,5-6H</b>	150	<b>67,00 €</b>	1515020050	<b>GD M 15X1,5-6H</b>	150	<b>37,00 €</b>	1515030050	<b>AD M 15X1,5-6H</b>	150	<b>37,00 €</b>
1516010050	<b>GLD M 16X1,5-6H</b>	150L	<b>69,00 €</b>	1516020050	<b>GD M 16X1,5-6H</b>	150	<b>38,00 €</b>	1516030050	<b>AD M 16X1,5-6H</b>	150	<b>38,00 €</b>
1517010050	<b>GLD M 17X1,5-6H</b>	150	<b>73,00 €</b>	1517020050	<b>GD M 17X1,5-6H</b>	150	<b>40,00 €</b>	1517030050	<b>AD M 17X1,5-6H</b>	150	<b>40,00 €</b>
1518010050	<b>GLD M 18X1,5-6H</b>	150L	<b>73,00 €</b>	1518020050	<b>GD M 18X1,5-6H</b>	150	<b>40,00 €</b>	1518030050	<b>AD M 18X1,5-6H</b>	150	<b>40,00 €</b>
1519010050	<b>GLD M 19X1,5-6H</b>	150	<b>78,00 €</b>	1519020050	<b>GD M 19X1,5-6H</b>	150	<b>43,00 €</b>	1519030050	<b>AD M 19X1,5-6H</b>	150	<b>43,00 €</b>
1520010050	<b>GLD M 20X1,5-6H</b>	150L	<b>78,00 €</b>	1520020050	<b>GD M 20X1,5-6H</b>	150	<b>43,00 €</b>	1520030050	<b>AD M 20X1,5-6H</b>	150	<b>43,00 €</b>
1521010050	<b>GLD M 21X1,5-6H</b>	150	<b>84,00 €</b>	1521020050	<b>GD M 21X1,5-6H</b>	150	<b>46,00 €</b>	1521030050	<b>AD M 21X1,5-6H</b>	150	<b>46,00 €</b>
1522010050	<b>GLD M 22X1,5-6H</b>	150L	<b>84,00 €</b>	1522020050	<b>GD M 22X1,5-6H</b>	150	<b>46,00 €</b>	1522030050	<b>AD M 22X1,5-6H</b>	150	<b>46,00 €</b>
1523010050	<b>GLD M 23X1,5-6H</b>	150	<b>90,00 €</b>	1523020050	<b>GD M 23x1,5-6H</b>	150	<b>49,00 €</b>	1523030050	<b>AD M 23x1,5-6H</b>	150	<b>49,00 €</b>
1524010050	<b>GLD M 24X1,5-6H</b>	150L	<b>90,00 €</b>	1524020050	<b>GD M 24X1,5-6H</b>	150	<b>49,00 €</b>	1524030050	<b>AD M 24X1,5-6H</b>	150	<b>49,00 €</b>
1525010050	<b>GLD M 25X1,5-6H</b>	150L	<b>92,00 €</b>	1525020050	<b>GD M 25X1,5-6H</b>	150	<b>51,00 €</b>	1525030050	<b>AD M 25X1,5-6H</b>	150	<b>51,00 €</b>
1526010050	<b>GLD M 26X1,5-6H</b>	150L	<b>96,00 €</b>	1526020050	<b>GD M 26X1,5-6H</b>	150	<b>53,00 €</b>	1526030050	<b>AD M 26X1,5-6H</b>	150	<b>53,00 €</b>
1527010050	<b>GLD M 27X1,5-6H</b>	150L	<b>99,00 €</b>	1527020050	<b>GD M 27X1,5-6H</b>	150	<b>55,00 €</b>	1527030050	<b>AD M 27X1,5-6H</b>	150	<b>55,00 €</b>
1528010050	<b>GLD M 28X1,5-6H</b>	150L	<b>102,00 €</b>	1528020050	<b>GD M 28X1,5-6H</b>	150	<b>56,00 €</b>	1528030050	<b>AD M 28X1,5-6H</b>	150	<b>56,00 €</b>
1530010050	<b>GLD M 30X1,5-6H</b>	150L	<b>108,00 €</b>	1530020050	<b>GD M 30X1,5-6H</b>	150	<b>60,00 €</b>	1530030050	<b>AD M 30X1,5-6H</b>	150	<b>60,00 €</b>
1532010050	<b>GLD M 32X1,5-6H</b>	150L	<b>112,00 €</b>	1532020050	<b>GD M 32X1,5-6H</b>	150	<b>62,00 €</b>	1532030050	<b>AD M 32X1,5-6H</b>	150	<b>62,00 €</b>
1533010050	<b>GLD M 33X1,5-6H</b>	150L	<b>117,00 €</b>	1533020050	<b>GD M 33X1,5-6H</b>	150	<b>64,00 €</b>	1533030050	<b>AD M 33X1,5-6H</b>	150	<b>64,00 €</b>
1534010050	<b>GLD M 34X1,5-6H</b>	150	<b>119,00 €</b>	1534020050	<b>GD M 34X1,5-6H</b>	150	<b>66,00 €</b>	1534030050	<b>AD M 34X1,5-6H</b>	150	<b>66,00 €</b>
1535010050	<b>GLD M 35X1,5-6H</b>	150L	<b>122,00 €</b>	1535020050	<b>GD M 35X1,5-6H</b>	150	<b>67,00 €</b>	1535030050	<b>AD M 35X1,5-6H</b>	150	<b>67,00 €</b>
1536010050	<b>GLD M 36X1,5-6H</b>	150L	<b>125,00 €</b>	1536020050	<b>GD M 36X1,5-6H</b>	150	<b>69,00 €</b>	1536030050	<b>AD M 36X1,5-6H</b>	150	<b>69,00 €</b>
1538010050	<b>GLD M 38X1,5-6H</b>	150L	<b>132,00 €</b>	1538020050	<b>GD M 38X1,5-6H</b>	150	<b>73,00 €</b>	1538030050	<b>AD M 38X1,5-6H</b>	150	<b>73,00 €</b>
1539010050	<b>GLD M 39X1,5-6H</b>	150	<b>139,00 €</b>	1539020050	<b>GD M 39X1,5-6H</b>	150	<b>76,00 €</b>	1539030050	<b>AD M 39X1,5-6H</b>	150	<b>76,00 €</b>
1540010050	<b>GLD M 40X1,5-6H</b>	150L	<b>139,00 €</b>	1540020050	<b>GD M 40X1,5-6H</b>	150	<b>76,00 €</b>	1540030050	<b>AD M 40X1,5-6H</b>	150	<b>76,00 €</b>
				1542020051	<b>GD M 42X1,5-6H</b>	151L	<b>78,00 €</b>	1542030051	<b>AD M 42X1,5-6H</b>	151L	<b>78,00 €</b>
				1545020051	<b>GD M 45X1,5-6H</b>	151L	<b>83,00 €</b>	1545030051	<b>AD M 45X1,5-6H</b>	151L	<b>83,00 €</b>
				1548020051	<b>GD M 48X1,5-6H</b>	151L	<b>88,00 €</b>	1548030051	<b>AD M 48X1,5-6H</b>	151L	<b>88,00 €</b>
				1550020051	<b>GD M 50X1,5-6H</b>	151L	<b>90,00 €</b>	1550030051	<b>AD M 50X1,5-6H</b>	151L	<b>90,00 €</b>
				1552020051	<b>GD M 52X1,5-6H</b>	151L	<b>94,00 €</b>	1552030051	<b>AD M 52X1,5-6H</b>	151L	<b>94,00 €</b>
				1555020051	<b>GD M 55X1,5-6H</b>	151L	<b>101,00 €</b>	1555030051	<b>AD M 55X1,5-6H</b>	151L	<b>101,00 €</b>
				1556020051	<b>GD M 56X1,5-6H</b>	151L	<b>103,00 €</b>	1556030051	<b>AD M 56X1,5-6H</b>	151L	<b>103,00 €</b>
				1558020051	<b>GD M 58X1,5-6H</b>	151L	<b>106,00 €</b>	1558030051	<b>AD M 58X1,5-6H</b>	151L	<b>106,00 €</b>
				1560020051	<b>GD M 60X1,5-6H</b>	151	<b>109,00 €</b>	1560030051	<b>AD M 60X1,5-6H</b>	151	<b>109,00 €</b>
				1562020051	<b>GD M 62X1,5-6H</b>	151L	<b>113,00 €</b>	1562030051	<b>AD M 62X1,5-6H</b>	151L	<b>113,00 €</b>
				1564020051	<b>GD M 64X1,5-6H</b>	151	<b>116,00 €</b>	1564030051	<b>AD M 64X1,5-6H</b>	151	<b>116,00 €</b>
				1565020051	<b>GD M 65X1,5-6H</b>	151L	<b>120,00 €</b>	1565030051	<b>AD M 65X1,5-6H</b>	151L	<b>120,00 €</b>
				1568020051	<b>GD M 68X1,5-6H</b>	151	<b>126,00 €</b>	1568030051	<b>AD M 68X1,5-6H</b>	151	<b>126,00 €</b>
				1570020051	<b>GD M 70X1,5-6H</b>	151	<b>129,00 €</b>	1570030051	<b>AD M 70X1,5-6H</b>	151	<b>129,00 €</b>
				1572020051	<b>GD M 72X1,5-6H</b>	151	<b>133,00 €</b>	1572030051	<b>AD M 72X1,5-6H</b>	151	<b>133,00 €</b>
				1575020051	<b>GD M 75X1,5-6H</b>	151	<b>139,00 €</b>	1575030051	<b>AD M 75X1,5-6H</b>	151	<b>139,00 €</b>
				1576020051	<b>GD M 76X1,5-6H</b>	151	<b>140,00 €</b>	1576030051	<b>AD M 76X1,5-6H</b>	151	<b>140,00 €</b>
				1578020051	<b>GD M 78X1,5-6H</b>	151	<b>144,00 €</b>	1578030051	<b>AD M 78X1,5-6H</b>	151	<b>144,00 €</b>

Anr.	Beschreibung	AGr.	Einzelpreis	Anr.	Beschreibung	AGr.	Einzelpreis	Anr.	Beschreibung	AGr.	Einzelpreis
<b>Metrisches Feingewinde DIN ISO 13 - Steigung 1,5</b>											
	1580020051	GD M 80X1,5-6H	151	147,00 €	1580030051	AD M 80X1,5-6H	151	147,00 €			
	1582020051	GD M 82X1,5-6H	151	150,00 €	1582030051	AD M 82x1,5-6H	151	150,00 €			
	1585020051	GD M 85X1,5-6H	151	157,00 €	1585030051	AD M 85X1,5-6H	151	157,00 €			
	1588020051	GD M 88x1,5-6H	151	163,00 €	1588030051	AD M 88x1,5-6H	151	163,00 €			
	1590020051	GD M 90X1,5-6H	151	166,00 €	1590030051	AD M 90X1,5-6H	151	166,00 €			
	1592020051	GD M 92x1,5-6H	151	169,00 €	1592030051	AD M 92x1,5-6H	151	169,00 €			
	1595020051	GD M 95X1,5-6H	151	174,00 €	1595030051	AD M 95X1,5-6H	151	174,00 €			
	1598020051	GD M 98X1,5-6H	151	181,00 €	1598030051	AD M 98X1,5-6H	151	181,00 €			
	1595220051	GD M100X1,5-6H	151	184,00 €	1595230051	AD M100X1,5-6H	151	184,00 €			
	1595420051	GD M105X1,5-6H	151	194,00 €	1595430051	AD M105X1,5-6H	151	194,00 €			
	1595620051	GD M110X1,5-6H	151	203,00 €	1595630051	AD M110X1,5-6H	151	203,00 €			
	1595820051	GD M115X1,5-6H	151	213,00 €	1595830051	AD M115X1,5-6H	151	213,00 €			
	1596020051	GD M120X1,5-6H	151	223,00 €	1596030051	AD M120X1,5-6H	151	223,00 €			
	1596220051	GD M125X1,5-6H	151	233,00 €	1596230051	AD M125X1,5-6H	151	233,00 €			
	1596420051	GD M130X1,5-6H	151	243,00 €	1596430051	AD M130X1,5-6H	151	243,00 €			
	1596620051	GD M135X1,5-6H	151	251,00 €	1596630051	AD M135X1,5-6H	151	251,00 €			
	1596820051	GD M140X1,5-6H	151	261,00 €	1596830051	AD M140X1,5-6H	151	261,00 €			
	1597020051	GD M145X1,5-6H	151	271,00 €	1597030051	AD M145X1,5-6H	151	271,00 €			
	1597220051	GD M150X1,5-6H	151	283,00 €	1597230051	AD M150X1,5-6H	151	283,00 €			
	1597420051	GD M155X1,5-6H	151	291,00 €	1597430051	AD M155X1,5-6H	151	291,00 €			
	1597620051	GD M160X1,5-6H	151	301,00 €	1597630051	AD M160X1,5-6H	151	301,00 €			
	1597820051	GD M165X1,5-6H	151	311,00 €	1597830051	AD M165X1,5-6H	151	311,00 €			
	1598020051	GD M170X1,5-6H	151	321,00 €	1598030051	AD M170X1,5-6H	151	321,00 €			
	1598220051	GD M175X1,5-6H	151	331,00 €	1598230051	AD M175X1,5-6H	151	331,00 €			
	1598420051	GD M180X1,5-6H	151	340,00 €	1598430051	AD M180X1,5-6H	151	340,00 €			
	1598620051	GD M185X1,5-6H	151	351,00 €	1598630051	AD M185X1,5-6H	151	351,00 €			
	1598820051	GD M190X1,5-6H	151	360,00 €	1598830051	AD M190X1,5-6H	151	360,00 €			
	1599020051	GD M195X1,5-6H	151	370,00 €	1599030051	AD M195X1,5-6H	151	370,00 €			
	1599220051	GD M200X1,5-6H	151	381,00 €	1599230051	AD M200X1,5-6H	151	381,00 €			

<b>Metrisches Feingewinde DIN ISO 13 - Steigung 2</b>											
2018010050	GLD M 18X2-6H	150	79,00 €	2018020050	GD M 18X2-6H	150	43,00 €	2018030050	AD M 18X2-6H	150	43,00 €
2019010050	GLD M 19x2-6H	150	84,00 €	2019020050	GD M 19X2-6H	150	46,00 €	2019030050	AD M 19X2-6H	150	46,00 €
2020010050	GLD M 20X2-6H	150L	80,00 €	2020020050	GD M 20X2-6H	150	44,00 €	2020030050	AD M 20X2-6H	150	44,00 €
2021010051	GLD M 21X2-6H	150	90,00 €	2021020050	GD M 21X2-6H	150	49,00 €	2021030050	AD M 21X2-6H	150	49,00 €
2022010050	GLD M 22X2-6H	150	88,00 €	2022020050	GD M 22X2-6H	150	60,00 €	2022030050	AD M 22X2-6H	150	48,00 €
2023010050	GLD M 23x2-6H	150	95,00 €	2023020050	GD M 23X2-6H	150	52,00 €	2023030050	AD M 23X2-6H	150	52,00 €
2024010050	GLD M 24X2-6H	150L	93,00 €	2024020050	GD M 24X2-6H	150	63,00 €	2024030050	AD M 24X2-6H	150	51,00 €
2025010050	GLD M 25X2-6H	150	97,00 €	2025020050	GD M 25X2-6H	150	65,00 €	2025030050	AD M 25X2-6H	150	53,00 €
2026010050	GLD M 26X2-6H	150	100,00 €	2026020050	GD M 26X2-6H	150	55,00 €	2026030050	AD M 26X2-6H	150	55,00 €
2027010050	GLD M 27X2-6H	150L	102,00 €	2027020050	GD M 27X2-6H	150	70,00 €	2027030050	AD M 27X2-6H	150	56,00 €
2028010050	GLD M 28X2-6H	150	107,00 €	2028020050	GD M 28X2-6H	150	72,00 €	2028030050	AD M 28X2-6H	150	59,00 €
2030010050	GLD M 30X2-6H	150L	112,00 €	2030020050	GD M 30X2-6H	150	62,00 €	2030030050	AD M 30X2-6H	150	62,00 €

Anr.	Beschreibung	AGr.	Einzelpreis	Anr.	Beschreibung	AGr.	Einzelpreis	Anr.	Beschreibung	AGr.	Einzelpreis
<b>Metrisches Feingewinde DIN ISO 13 - Steigung 2</b>											
2032010050	<b>GLD M 32X2-6H</b>	150	<b>117,00 €</b>	2032020050	<b>GD M 32X2-6H</b>	150	<b>64,00 €</b>	2032030050	<b>AD M 32X2-6H</b>	150	<b>64,00 €</b>
2033010050	<b>GLD M 33X2-6H</b>	150L	<b>120,00 €</b>	2033020050	<b>GD M 33X2-6H</b>	150	<b>82,00 €</b>	2033030050	<b>AD M 33X2-6H</b>	150	<b>66,00 €</b>
2034010050	<b>GLD M 34X2-6H</b>	150	<b>124,00 €</b>	2034020050	<b>GD M 34X2-6H</b>	150	<b>68,00 €</b>	2034030050	<b>AD M 34X2-6H</b>	150	<b>68,00 €</b>
2035010050	<b>GLD M 35X2-6H</b>	150	<b>127,00 €</b>	2035020050	<b>GD M 35X2-6H</b>	150	<b>70,00 €</b>	2035030050	<b>AD M 35X2-6H</b>	150	<b>70,00 €</b>
2036010050	<b>GLD M 36X2-6H</b>	150L	<b>129,00 €</b>	2036020050	<b>GD M 36X2-6H</b>	150	<b>71,00 €</b>	2036030050	<b>AD M 36X2-6H</b>	150	<b>71,00 €</b>
2038010050	<b>GLD M 38X2-6H</b>	150	<b>140,00 €</b>	2038020050	<b>GD M 38X2-6H</b>	150	<b>77,00 €</b>	2038030050	<b>AD M 38X2-6H</b>	150	<b>77,00 €</b>
2039010050	<b>GLD M 39X2-6H</b>	150	<b>141,00 €</b>	2039020050	<b>GD M 39X2-6H</b>	150	<b>96,00 €</b>	2039030050	<b>AD M 39X2-6H</b>	150	<b>78,00 €</b>
2040010050	<b>GLD M 40X2-6H</b>	150L	<b>147,00 €</b>	2040020050	<b>GD M 40X2-6H</b>	150	<b>81,00 €</b>	2040030050	<b>AD M 40X2-6H</b>	150	<b>81,00 €</b>
				2042020051	<b>GD M 42X2-6H</b>	151L	<b>77,00 €</b>	2042030051	<b>AD M 42X2-6H</b>	151L	<b>77,00 €</b>
				2045020051	<b>GD M 45X2-6H</b>	151L	<b>83,00 €</b>	2045030051	<b>AD M 45X2-6H</b>	151L	<b>83,00 €</b>
				2048020051	<b>GD M 48X2-6H</b>	151L	<b>86,00 €</b>	2048030051	<b>AD M 48X2-6H</b>	151L	<b>86,00 €</b>
				2050020051	<b>GD M 50X2-6H</b>	151L	<b>90,00 €</b>	2050030051	<b>AD M 50X2-6H</b>	151L	<b>90,00 €</b>
				2052020051	<b>GD M 52X2-6H</b>	151L	<b>94,00 €</b>	2052030051	<b>AD M 52X2-6H</b>	151L	<b>94,00 €</b>
				2055020051	<b>GD M 55X2-6H</b>	151	<b>100,00 €</b>	2055030051	<b>AD M 55X2-6H</b>	151	<b>100,00 €</b>
				2056020051	<b>GD M 56X2-6H</b>	151	<b>102,00 €</b>	2056030051	<b>AD M 56X2-6H</b>	151	<b>102,00 €</b>
				2058020051	<b>GD M 58X2-6H</b>	151	<b>106,00 €</b>	2058030051	<b>AD M 58X2-6H</b>	151	<b>106,00 €</b>
				2060020051	<b>GD M 60X2-6H</b>	151L	<b>109,00 €</b>	2060030051	<b>AD M 60X2-6H</b>	151L	<b>109,00 €</b>
				2062020051	<b>GD M 62X2-6H</b>	151L	<b>113,00 €</b>	2062030051	<b>AD M 62X2-6H</b>	151L	<b>113,00 €</b>
				2064020051	<b>GD M 64X2-6H</b>	151	<b>116,00 €</b>	2064030051	<b>AD M 64X2-6H</b>	151	<b>116,00 €</b>
				2065020051	<b>GD M 65X2-6H</b>	151	<b>119,00 €</b>	2065030051	<b>AD M 65X2-6H</b>	151	<b>119,00 €</b>
				2068020051	<b>GD M 68X2-6H</b>	151	<b>125,00 €</b>	2068030051	<b>AD M 68X2-6H</b>	151	<b>125,00 €</b>
				2070020051	<b>GD M 70X2-6H</b>	151	<b>128,00 €</b>	2070030051	<b>AD M 70X2-6H</b>	151	<b>128,00 €</b>
				2072020051	<b>GD M 72X2-6H</b>	151	<b>132,00 €</b>	2072030051	<b>AD M 72X2-6H</b>	151	<b>132,00 €</b>
				2075020051	<b>GD M 75X2-6H</b>	151	<b>138,00 €</b>	2075030051	<b>AD M 75X2-6H</b>	151	<b>138,00 €</b>
				2076020051	<b>GD M 76X2-6H</b>	151	<b>139,00 €</b>	2076030051	<b>AD M 76X2-6H</b>	151	<b>139,00 €</b>
				2078020051	<b>GD M 78X2-6H</b>	151	<b>143,00 €</b>	2078030051	<b>AD M 78X2-6H</b>	151	<b>143,00 €</b>
				2080020051	<b>GD M 80X2-6H</b>	151	<b>146,00 €</b>	2080030051	<b>AD M 80X2-6H</b>	151	<b>146,00 €</b>
				2082020051	<b>GD M 82X2-6H</b>	151	<b>149,00 €</b>	2082030051	<b>AD M 82X2-6H</b>	151	<b>149,00 €</b>
				2085020051	<b>GD M 85X2-6H</b>	151	<b>157,00 €</b>	2085030051	<b>AD M 85X2-6H</b>	151	<b>157,00 €</b>
				2088020051	<b>GD M 88x2-6H</b>	151	<b>163,00 €</b>	2088030051	<b>AD M 88x2-6H</b>	151	<b>163,00 €</b>
				2090020051	<b>GD M 90X2-6H</b>	151	<b>165,00 €</b>	2090030051	<b>AD M 90X2-6H</b>	151	<b>165,00 €</b>
				2092020051	<b>GD M 92X2-6H</b>	151	<b>169,00 €</b>	2092030051	<b>AD M 92X2-6H</b>	151	<b>169,00 €</b>
				2095020051	<b>GD M 95X2-6H</b>	151	<b>173,00 €</b>	2095030051	<b>AD M 95X2-6H</b>	151	<b>173,00 €</b>
				2095120051	<b>GD M 98X2-6H</b>	151	<b>180,00 €</b>	2095130051	<b>AD M 98X2-6H</b>	151	<b>180,00 €</b>
				2095220051	<b>GD M100X2-6H</b>	151	<b>183,00 €</b>	2095230051	<b>AD M100X2-6H</b>	151	<b>183,00 €</b>
				2095420051	<b>GD M105X2-6H</b>	151	<b>193,00 €</b>	2095430051	<b>AD M105X2-6H</b>	151	<b>193,00 €</b>
				2095620051	<b>GD M110X2-6H</b>	151	<b>203,00 €</b>	2095630051	<b>AD M110X2-6H</b>	151	<b>203,00 €</b>
				2095820051	<b>GD M115X2-6H</b>	151	<b>211,00 €</b>	2095830051	<b>AD M115X2-6H</b>	151	<b>211,00 €</b>
				2096020051	<b>GD M120X2-6H</b>	151	<b>221,00 €</b>	2096030051	<b>AD M120X2-6H</b>	151	<b>221,00 €</b>
				2096220051	<b>GD M125X2-6H</b>	151	<b>231,00 €</b>	2096230051	<b>AD M125X2-6H</b>	151	<b>231,00 €</b>
				2096420051	<b>GD M130X2-6H</b>	151	<b>243,00 €</b>	2096430051	<b>AD M130X2-6H</b>	151	<b>243,00 €</b>
				2096620051	<b>GD M135X2-6H</b>	151	<b>251,00 €</b>	2096630051	<b>AD M135X2-6H</b>	151	<b>251,00 €</b>
				2096820051	<b>GD M140X2-6H</b>	151	<b>260,00 €</b>	2096830051	<b>AD M140X2-6H</b>	151	<b>260,00 €</b>
				2097020051	<b>GD M145X2-6H</b>	151	<b>271,00 €</b>	2097030051	<b>AD M145X2-6H</b>	151	<b>271,00 €</b>

Anr.	Beschreibung	AGr.	Einzelpreis	Anr.	Beschreibung	AGr.	Einzelpreis	Anr.	Beschreibung	AGr.	Einzelpreis
<b>Metrisches Feingewinde DIN ISO 13 - Steigung 2</b>											
				2097220051	<b>GD M150X2-6H</b>	151	<b>283,00 €</b>	2097230051	<b>AD M150X2-6H</b>	151	<b>283,00 €</b>
				2097420051	<b>GD M155X2-6H</b>	151	<b>291,00 €</b>	2097430051	<b>AD M155X2-6H</b>	151	<b>291,00 €</b>
				2097620051	<b>GD M160X2-6H</b>	151	<b>301,00 €</b>	2097630051	<b>AD M160X2-6H</b>	151	<b>301,00 €</b>
				2097820051	<b>GD M165X2-6H</b>	151	<b>311,00 €</b>	2097830051	<b>AD M165X2-6H</b>	151	<b>311,00 €</b>
				2098020051	<b>GD M170X2-6H</b>	151	<b>321,00 €</b>	2098030051	<b>AD M170X2-6H</b>	151	<b>321,00 €</b>
				2098220051	<b>GD M175X2-6H</b>	151	<b>331,00 €</b>	2098230051	<b>AD M175X2-6H</b>	151	<b>331,00 €</b>
				2098420051	<b>GD M180X2-6H</b>	151	<b>340,00 €</b>	2098430051	<b>AD M180X2-6H</b>	151	<b>340,00 €</b>
				2098620051	<b>GD M185X2-6H</b>	151	<b>351,00 €</b>	2098630051	<b>AD M185X2-6H</b>	151	<b>351,00 €</b>
				2098820051	<b>GD M190X2-6H</b>	151	<b>360,00 €</b>	2098830051	<b>AD M190X2-6H</b>	151	<b>360,00 €</b>
				2099020051	<b>GD M195X2-6H</b>	151	<b>370,00 €</b>	2099030051	<b>AD M195X2-6H</b>	151	<b>370,00 €</b>
				2099220051	<b>GD M200X2-6H</b>	151	<b>380,00 €</b>	2099230051	<b>AD M200X2-6H</b>	151	<b>380,00 €</b>

<b>Metrisches Feingewinde DIN ISO 13 - Steigung 3</b>											
3030010049	<b>GLD M 30X3-6H</b>	150	<b>120,00 €</b>	3030020050	<b>GD M 30X3-6H</b>	150	<b>66,00 €</b>	3030030050	<b>AD M 30X3-6H</b>	150	<b>66,00 €</b>
3032010050	<b>GLD M 32X3-6H</b>	150	<b>124,00 €</b>	3032020050	<b>GD M 32X3-6H</b>	150	<b>68,00 €</b>	3032030050	<b>AD M 32X3-6H</b>	150	<b>68,00 €</b>
3033010050	<b>GLD M 33X3-6H</b>	150	<b>128,00 €</b>	3033020050	<b>GD M 33X3-6H</b>	150	<b>70,00 €</b>	3033030050	<b>AD M 33X3-6H</b>	150	<b>70,00 €</b>
3034010051	<b>GLD M 34X3-6H</b>	150	<b>134,00 €</b>	3034020050	<b>GD M 34X3-6H</b>	150	<b>74,00 €</b>	3034030050	<b>AD M 34X3-6H</b>	150	<b>74,00 €</b>
3035010050	<b>GLD M 35X3-6H</b>	150	<b>138,00 €</b>	3035020050	<b>GD M 35X3-6H</b>	150	<b>76,00 €</b>	3035030050	<b>AD M 35X3-6H</b>	150	<b>76,00 €</b>
3036010050	<b>GLD M 36X3-6H</b>	150	<b>138,00 €</b>	3036020050	<b>GD M 36X3-6H</b>	150	<b>76,00 €</b>	3036030050	<b>AD M 36X3-6H</b>	150	<b>76,00 €</b>
3038010051	<b>GLD M 38X3-6H</b>	150	<b>151,00 €</b>	3038020050	<b>GD M 38X3-6H</b>	150	<b>83,00 €</b>	3038030050	<b>AD M 38X3-6H</b>	150	<b>83,00 €</b>
3039010050	<b>GLD M 39X3-6H</b>	150	<b>151,00 €</b>	3039020050	<b>GD M 39X3-6H</b>	150	<b>83,00 €</b>	3039030050	<b>AD M 39X3-6H</b>	150	<b>83,00 €</b>
3040010050	<b>GLD M 40X3-6H</b>	150	<b>154,00 €</b>	3040020050	<b>GD M 40X3-6H</b>	150	<b>85,00 €</b>	3040030050	<b>AD M 40X3-6H</b>	150	<b>85,00 €</b>
				3042020051	<b>GD M 42X3-6H</b>	151	<b>85,00 €</b>	3042030051	<b>AD M 42X3-6H</b>	151	<b>85,00 €</b>
				3045020051	<b>GD M 45X3-6H</b>	151	<b>91,00 €</b>	3045030051	<b>AD M 45X3-6H</b>	151	<b>91,00 €</b>
				3048020051	<b>GD M 48X3-6H</b>	151	<b>97,00 €</b>	3048030051	<b>AD M 48X3-6H</b>	151	<b>97,00 €</b>
				3050020051	<b>GD M 50X3-6H</b>	151	<b>101,00 €</b>	3050030051	<b>AD M 50X3-6H</b>	151	<b>101,00 €</b>
				3052020051	<b>GD M 52X3-6H</b>	151	<b>106,00 €</b>	3052030051	<b>AD M 52X3-6H</b>	151	<b>106,00 €</b>
				3055020051	<b>GD M 55X3-6H</b>	151	<b>111,00 €</b>	3055030051	<b>AD M 55X3-6H</b>	151	<b>111,00 €</b>
				3056020051	<b>GD M 56X3-6H</b>	151	<b>113,00 €</b>	3056030051	<b>AD M 56X3-6H</b>	151	<b>113,00 €</b>
				3058020051	<b>GD M 58X3-6H</b>	151	<b>117,00 €</b>	3058030051	<b>AD M 58X3-6H</b>	151	<b>117,00 €</b>
				3060020051	<b>GD M 60X3-6H</b>	151	<b>123,00 €</b>	3060030051	<b>AD M 60X3-6H</b>	151	<b>123,00 €</b>
				3062020051	<b>GD M 62X3-6H</b>	151	<b>126,00 €</b>	3062030051	<b>AD M 62X3-6H</b>	151	<b>126,00 €</b>
				3064020051	<b>GD M 64X3-6H</b>	151	<b>127,00 €</b>	3064030051	<b>AD M 64X3-6H</b>	151	<b>127,00 €</b>
				3065020051	<b>GD M 65X3-6H</b>	151	<b>131,00 €</b>	3065030051	<b>AD M 65X3-6H</b>	151	<b>131,00 €</b>
				3068020051	<b>GD M 68X3-6H</b>	151	<b>136,00 €</b>	3068030051	<b>AD M 68X3-6H</b>	151	<b>136,00 €</b>
				3070020051	<b>GD M 70X3-6H</b>	151	<b>141,00 €</b>	3070030051	<b>AD M 70X3-6H</b>	151	<b>141,00 €</b>
				3072020051	<b>GD M 72X3-6H</b>	151	<b>146,00 €</b>	3072030051	<b>AD M 72X3-6H</b>	151	<b>146,00 €</b>
				3075020051	<b>GD M 75X3-6H</b>	151	<b>151,00 €</b>	3075030051	<b>AD M 75X3-6H</b>	151	<b>151,00 €</b>
				3076020051	<b>GD M 76X3-6H</b>	151	<b>153,00 €</b>	3076030051	<b>AD M 76X3-6H</b>	151	<b>153,00 €</b>
				3078020051	<b>GD M 78x3-6H</b>	151	<b>192,00 €</b>	3078030051	<b>AD M 78x3-6H</b>	151	<b>192,00 €</b>
				3080020051	<b>GD M 80X3-6H</b>	151	<b>160,00 €</b>	3080030051	<b>AD M 80X3-6H</b>	151	<b>160,00 €</b>
				3082020051	<b>GD M 82X3-6H</b>	151	<b>224,00 €</b>	3082030051	<b>AD M 82X3-6H</b>	151	<b>224,00 €</b>
				3085020051	<b>GD M 85X3-6H</b>	151	<b>171,00 €</b>	3085030051	<b>AD M 85X3-6H</b>	151	<b>171,00 €</b>



ANr.	Beschreibung	AGr.	Einzelpreis	ANr.	Beschreibung	AGr.	Einzelpreis	ANr.	Beschreibung	AGr.	Einzelpreis
<b>Metrisches Feingewinde DIN ISO 13 - Steigung 3</b>											
	3088020051	GD	M 88X3-6H	151	244,00 €		3088030051	AD	M 88X3-6H	151	244,00 €
	3090020051	GD	M 90X3-6H	151	183,00 €		3090030051	AD	M 90X3-6H	151	183,00 €
	3092020051	GD	M 92x3-6H	151	258,00 €		3092030051	AD	M 92x3-6H	151	258,00 €
	3095020051	GD	M 95X3-6H	151	193,00 €		3095030051	AD	M 95X3-6H	151	193,00 €
	3098020051	GD	M 98X3-6H	151	271,00 €		3098030051	AD	M 98X3-6H	151	271,00 €
	3095220051	GD	M100X3-6H	151	203,00 €		3095230051	AD	M100X3-6H	151	203,00 €
	3095420051	GD	M105X3-6H	151	214,00 €		3095430051	AD	M105X3-6H	151	214,00 €
	3095620051	GD	M110X3-6H	151	223,00 €		3095630051	AD	M110X3-6H	151	223,00 €
	3095820051	GD	M115X3-6H	151	233,00 €		3095830051	AD	M115X3-6H	151	233,00 €
	3096020051	GD	M120X3-6H	151	243,00 €		3096030051	AD	M120X3-6H	151	243,00 €
	3096220051	GD	M125X3-6H	151	254,00 €		3096230051	AD	M125X3-6H	151	254,00 €
	3096420051	GD	M130X3-6H	151	263,00 €		3096430051	AD	M130X3-6H	151	263,00 €
	3096620051	GD	M135X3-6H	151	274,00 €		3096630051	AD	M135X3-6H	151	274,00 €
	3096820051	GD	M140X3-6H	151	286,00 €		3096830051	AD	M140X3-6H	151	286,00 €
	3097020051	GD	M145X3-6H	151	297,00 €		3097030051	AD	M145X3-6H	151	297,00 €
	3097220051	GD	M150X3-6H	151	309,00 €		3097230051	AD	M150X3-6H	151	309,00 €
	3097420051	GD	M155X3-6H	151	317,00 €		3097430051	AD	M155X3-6H	151	317,00 €
	3097620051	GD	M160X3-6H	151	329,00 €		3097630051	AD	M160X3-6H	151	329,00 €
	3097820051	GD	M165X3-6H	151	340,00 €		3097830051	AD	M165X3-6H	151	340,00 €
	3098020051	GD	M170X3-6H	151	351,00 €		3098030051	AD	M170X3-6H	151	351,00 €
	3098220051	GD	M175X3-6H	151	363,00 €		3098230051	AD	M175X3-6H	151	363,00 €
	3098420051	GD	M180X3-6H	151	374,00 €		3098430051	AD	M180X3-6H	151	374,00 €
	3098620051	GD	M185X3-6H	151	386,00 €		3098630051	AD	M185X3-6H	151	386,00 €
	3098820051	GD	M190X3-6H	151	397,00 €		3098830051	AD	M190X3-6H	151	397,00 €
	3099020051	GD	M195X3-6H	151	406,00 €		3099030051	AD	M195X3-6H	151	406,00 €
	3099220051	GD	M200X3-6H	151	417,00 €		3099230051	AD	M200X3-6H	151	417,00 €
<b>Metrisches Feingewinde DIN ISO 13 - Steigung 4</b>											
	4042020051	GD	M 42X4-6H	151	86,00 €		4042030051	AD	M 42X4-6H	151	86,00 €
	4045020051	GD	M 45X4-6H	151	91,00 €		4045030051	AD	M 45X4-6H	151	91,00 €
	4048020051	GD	M 48X4-6H	151	97,00 €		4048030051	AD	M 48X4-6H	151	97,00 €
	4050020051	GD	M 50X4-6H	151	166,00 €		4050030051	AD	M 50X4-6H	151	166,00 €
	4052020051	GD	M 52X4-6H	151	106,00 €		4052030051	AD	M 52X4-6H	151	106,00 €
	4055020051	GD	M 55X4-6H	151	111,00 €		4055030051	AD	M 55X4-6H	151	111,00 €
	4056020051	GD	M 56X4-6H	151	113,00 €		4056030051	AD	M 56X4-6H	151	113,00 €
	4058020051	GD	M 58X4-6H	151	117,00 €		4058030051	AD	M 58X4-6H	151	117,00 €
	4060020051	GD	M 60X4-6H	151	123,00 €		4060030051	AD	M 60X4-6H	151	123,00 €
	4062020051	GD	M 62X4-6H	151	126,00 €		4062030051	AD	M 62X4-6H	151	126,00 €
	4064020051	GD	M 64X4-6H	151	127,00 €		4064030051	AD	M 64X4-6H	151	127,00 €
	4065020051	GD	M 65X4-6H	151	130,00 €		4065030051	AD	M 65X4-6H	151	130,00 €
	4068020051	GD	M 68X4-6H	151	136,00 €		4068030051	AD	M 68X4-6H	151	136,00 €
	4070020051	GD	M 70X4-6H	151	141,00 €		4070030051	AD	M 70X4-6H	151	141,00 €
	4072020051	GD	M 72X4-6H	151	145,00 €		4072030051	AD	M 72X4-6H	151	145,00 €

ANr.	Beschreibung	AGr.	Einzelpreis	ANr.	Beschreibung	AGr.	Einzelpreis	ANr.	Beschreibung	AGr.	Einzelpreis
------	--------------	------	-------------	------	--------------	------	-------------	------	--------------	------	-------------

**Metrisches Feingewinde DIN ISO 13 - Steigung 4**

4075020051	GD M 75X4-6H	151	151,00 €	4075030051	AD M 75X4-6H	151	151,00 €
4076020051	GD M 76X4-6H	151	153,00 €	4076030051	AD M 76X4-6H	151	153,00 €
4078020051	GD M 78X4-6H	151	267,00 €	4078030051	AD M 78X4-6H	151	267,00 €
4080020051	GD M 80X4-6H	151	160,00 €	4080030051	AD M 80X4-6H	151	160,00 €
4082020051	GD M 82X4-6H	151	284,00 €	4082030051	AD M 82X4-6H	151	284,00 €
4085020051	GD M 85X4-6H	151	172,00 €	4085030051	AD M 85X4-6H	151	172,00 €
4088020051	GD M 88X4-6H	151	309,00 €	4088030051	AD M 88X4-6H	151	309,00 €
4090020051	GD M 90X4-6H	151	182,00 €	4090030051	AD M 90X4-6H	151	182,00 €
4092020051	GD M 92X4-6H	151	326,00 €	4092030051	AD M 92X4-6H	151	326,00 €
4095020051	GD M 95X4-6H	151	193,00 €	4095030051	AD M 95X4-6H	151	193,00 €
4098020051	GD M 98X4-6H	151	343,00 €	4098030051	AD M 98X4-6H	151	343,00 €
4095220051	GD M100X4-6H	151	202,00 €	4095230051	AD M100X4-6H	151	202,00 €
4095420051	GD M105X4-6H	151	213,00 €	4095430051	AD M105X4-6H	151	213,00 €
4095620051	GD M110X4-6H	151	223,00 €	4095630051	AD M110X4-6H	151	223,00 €
4095820051	GD M115X4-6H	151	233,00 €	4095830051	AD M115X4-6H	151	233,00 €
4096020051	GD M120X4-6H	151	243,00 €	4096030051	AD M120X4-6H	151	243,00 €
4096220051	GD M125X4-6H	151	253,00 €	4096230051	AD M125X4-6H	151	253,00 €
4096420051	GD M130X4-6H	151	263,00 €	4096430051	AD M130X4-6H	151	263,00 €
4096620051	GD M135X4-6H	151	274,00 €	4096630051	AD M135X4-6H	151	274,00 €
4096820051	GD M140X4-6H	151	286,00 €	4096830051	AD M140X4-6H	151	286,00 €
4097020051	GD M145X4-6H	151	297,00 €	4097030051	AD M145X4-6H	151	297,00 €
4097220051	GD M150X4-6H	151	309,00 €	4097230051	AD M150X4-6H	151	309,00 €
4097420051	GD M155X4-6H	151	319,00 €	4097430051	AD M155X4-6H	151	319,00 €
4097620051	GD M160X4-6H	151	330,00 €	4097630051	AD M160X4-6H	151	330,00 €
4097820051	GD M165X4-6H	151	340,00 €	4097830051	AD M165X4-6H	151	340,00 €
4098020051	GD M170X4-6H	151	351,00 €	4098030051	AD M170X4-6H	151	351,00 €
4098220051	GD M175X4-6H	151	363,00 €	4098230051	AD M175X4-6H	151	363,00 €
4098420051	GD M180X4-6H	151	374,00 €	4098430051	AD M180X4-6H	151	374,00 €
4098620051	GD M185X4-6H	151	386,00 €	4098630051	AD M185X4-6H	151	386,00 €
4098820051	GD M190X4-6H	151	397,00 €	4098830051	AD M190X4-6H	151	397,00 €
4099020051	GD M195X4-6H	151	406,00 €	4099030051	AD M195X4-6H	151	406,00 €
4099220051	GD M200X4-6H	151	417,00 €	4099230051	AD M200X4-6H	151	417,00 €

**Metrisches Feingewinde DIN ISO 13 - Steigung 6**

6070020051	GD M 70X6-6H	151	154,00 €	6070030051	AD M 70X6-6H	151	154,00 €
6072020051	GD M 72X6-6H	151	159,00 €	6072030051	AD M 72X6-6H	151	159,00 €
6075020051	GD M 75X6-6H	151	169,00 €	6075030051	AD M 75X6-6H	151	169,00 €
6076020051	GD M 76X6-6H	151	256,00 €	6076030051	AD M 76X6-6H	151	256,00 €
6078020051	GD M 78X6-6H	151	279,00 €	6078030051	AD M 78X6-6H	151	279,00 €
6080020051	GD M 80X6-6H	151	171,00 €	6080030051	AD M 80X6-6H	151	171,00 €
6082020051	GD M 82X6-6H	151	299,00 €	6082030051	AD M 82X6-6H	151	299,00 €
6085020051	GD M 85X6-6H	151	183,00 €	6085030051	AD M 85X6-6H	151	183,00 €
6088020051	GD M 88X6-6H	151	325,00 €	6088030051	AD M 88X6-6H	151	325,00 €

Anr.	Beschreibung	AGr.	Einzelpreis	Anr.	Beschreibung	AGr.	Einzelpreis	Anr.	Beschreibung	AGr.	Einzelpreis
<b>Metrisches Feingewinde DIN ISO 13 - Steigung 6</b>											
	6090020051	GD	M 90X6-6H	151	197,00 €		6090030051	AD	M 90X6-6H	151	197,00 €
	6092020051	GD	M 92X6-6H	151	343,00 €		6092030051	AD	M 92X6-6H	151	343,00 €
	6095020051	GD	M 95X6-6H	151	209,00 €		6095030051	AD	M 95X6-6H	151	209,00 €
	6098020051	GD	M 98X6-6H	151	361,00 €		6098030051	AD	M 98X6-6H	151	361,00 €
	6095220051	GD	M100X6-6H	151	220,00 €		6095230051	AD	M100X6-6H	151	220,00 €
	6095420051	GD	M105X6-6H	151	231,00 €		6095430051	AD	M105X6-6H	151	231,00 €
	6095620051	GD	M110X6-6H	151	243,00 €		6095630051	AD	M110X6-6H	151	243,00 €
	6095820051	GD	M115X6-6H	151	254,00 €		6095830051	AD	M115X6-6H	151	254,00 €
	6096020051	GD	M120X6-6H	151	267,00 €		6096030051	AD	M120X6-6H	151	267,00 €
	6096220051	GD	M125X6-6H	151	279,00 €		6096230051	AD	M125X6-6H	151	279,00 €
	6096420051	GD	M130X6-6H	151	291,00 €		6096430051	AD	M130X6-6H	151	291,00 €
	6096620051	GD	M135X6-6H	151	303,00 €		6096630051	AD	M135X6-6H	151	303,00 €
	6096820051	GD	M140X6-6H	151	314,00 €		6096830051	AD	M140X6-6H	151	314,00 €
	6097020051	GD	M145X6-6H	151	329,00 €		6097030051	AD	M145X6-6H	151	329,00 €
	6097220051	GD	M150X6-6H	151	340,00 €		6097230051	AD	M150X6-6H	151	340,00 €
	6097420051	GD	M155X6-6H	151	351,00 €		6097430051	AD	M155X6-6H	151	351,00 €
	6097620051	GD	M160X6-6H	151	363,00 €		6097630051	AD	M160X6-6H	151	363,00 €
	6097820051	GD	M165X6-6H	151	374,00 €		6097830051	AD	M165X6-6H	151	374,00 €
	6098020051	GD	M170X6-6H	151	386,00 €		6098030051	AD	M170X6-6H	151	386,00 €
	6098220051	GD	M175X6-6H	151	397,00 €		6098230051	AD	M175X6-6H	151	397,00 €
	6098420051	GD	M180X6-6H	151	411,00 €		6098430051	AD	M180X6-6H	151	411,00 €
	6098620051	GD	M185X6-6H	151	423,00 €		6098630051	AD	M185X6-6H	151	423,00 €
	6098820051	GD	M190X6-6H	151	434,00 €		6098830051	AD	M190X6-6H	151	434,00 €
	6099020051	GD	M195X6-6H	151	446,00 €		6099030051	AD	M195X6-6H	151	446,00 €
	6099220051	GD	M200X6-6H	151	457,00 €		6099230051	AD	M200X6-6H	151	457,00 €

<b>Whitworth Rohrgewinde DIN ISO 228</b>																	
7000110050	GLD	G 1/8	DIN 228	150L	67,00 €	7000120050	GD	G 1/8	DIN 228	150	37,00 €	7000130050	AD	G 1/8	DIN 228	150	37,00 €
7000210050	GLD	G 1/4	DIN 228	150L	72,00 €	7000220050	GD	G 1/4	DIN 228	150	40,00 €	7000230050	AD	G 1/4	DIN 228	150	40,00 €
7000310050	GLD	G 3/8	DIN 228	150L	83,00 €	7000320050	GD	G 3/8	DIN 228	150	46,00 €	7000330050	AD	G 3/8	DIN 228	150	46,00 €
7000410050	GLD	G 1/2	DIN 228	150L	95,00 €	7000420050	GD	G 1/2	DIN 228	150	52,00 €	7000430050	AD	G 1/2	DIN 228	150	52,00 €
7000510050	GLD	G 5/8	DIN 228	150	103,00 €	7000520050	GD	G 5/8	DIN 228	150	57,00 €	7000530050	AD	G 5/8	DIN 228	150	57,00 €
7000610050	GLD	G 3/4	DIN 228	150L	110,00 €	7000620050	GD	G 3/4	DIN 228	150	61,00 €	7000630050	AD	G 3/4	DIN 228	150	61,00 €
7000710050	GLD	G 7/8	DIN 228	150	126,00 €	7000720050	GD	G 7/8	DIN 228	150	69,00 €	7000730050	AD	G 7/8	DIN 228	150	69,00 €
7000810050	GLD	G 1	DIN 228	150L	136,00 €	7000820050	GD	G 1	DIN 228	150	75,00 €	7000830050	AD	G 1	DIN 228	150	75,00 €
7000910050	GLD	G 1 1/8	DIN 228	150	156,00 €	7000920050	GD	G 1 1/8	DIN 228	150	86,00 €	7000930050	AD	G 1 1/8	DIN 228	150	86,00 €
						7001020051	GD	G 1 1/4	DIN 228	151L	92,00 €	7001030051	AD	G 1 1/4	DIN 228	151L	92,00 €
						7002420051	GD	G 1 3/8	DIN 228	151	125,00 €	7002430051	AD	G 1 3/8	DIN 228	151	125,00 €
						7001120051	GD	G 1 1/2	DIN 228	151L	108,00 €	7001130051	AD	G 1 1/2	DIN 228	151L	108,00 €
						7001220051	GD	G 1 3/4	DIN 228	151L	122,00 €	7001230051	AD	G 1 3/4	DIN 228	151L	122,00 €
						7001320051	GD	G 2	DIN 228	151L	136,00 €	7001330051	AD	G 2	DIN 228	151L	136,00 €
						7001420051	GD	G 2 1/4	DIN 228	151L	148,00 €	7001430051	AD	G 2 1/4	DIN 228	151L	148,00 €
						7001520051	GD	G 2 1/2	DIN 228	151L	167,00 €	7001530051	AD	G 2 1/2	DIN 228	151L	167,00 €



Anr.	Beschreibung	AGr.	Einzelpreis	Anr.	Beschreibung	AGr.	Einzelpreis	Anr.	Beschreibung	AGr.	Einzelpreis
<b>Whitworth Rohrgewinde DIN ISO 228</b>											
				7001620051	<b>GD G 2 3/4 DIN 228</b>	151L	<b>182,00 €</b>	7001630051	<b>AD G 2 3/4 DIN 228</b>	151L	<b>182,00 €</b>
				7001720051	<b>GD G 3 DIN 228</b>	151L	<b>196,00 €</b>	7001730051	<b>AD G 3 DIN 228</b>	151L	<b>196,00 €</b>
				7002520051	<b>GD G 3 1/4 DIN 228</b>	151	<b>280,00 €</b>	7002530051	<b>AD G 3 1/4 DIN 228</b>	151	<b>280,00 €</b>
				7001820051	<b>GD G 3 1/2 DIN 228</b>	151L	<b>226,00 €</b>	7001830051	<b>AD G 3 1/2 DIN 228</b>	151L	<b>226,00 €</b>
				7002620051	<b>GD G 3 3/4 DIN 228</b>	151	<b>305,00 €</b>	7002630051	<b>AD G 3 3/4 DIN 228</b>	151	<b>305,00 €</b>
				7001920051	<b>GD G 4 DIN 228</b>	151	<b>254,00 €</b>	7001930051	<b>AD G 4 DIN 228</b>	151	<b>254,00 €</b>
				7002020051	<b>GD G 4 1/2 DIN 228</b>	151	<b>298,00 €</b>	7002030051	<b>AD G 4 1/2 DIN 228</b>	151	<b>298,00 €</b>
				7002120051	<b>GD G 5 DIN 228</b>	151	<b>330,00 €</b>	7002130051	<b>AD G 5 DIN 228</b>	151	<b>330,00 €</b>
				7002220051	<b>GD G 5 1/2 DIN 228</b>	151	<b>356,00 €</b>	7002230051	<b>AD G 5 1/2 DIN 228</b>	151	<b>356,00 €</b>
				7002320051	<b>GD G 6 DIN 228</b>	151	<b>392,00 €</b>	7002330051	<b>AD G 6 DIN 228</b>	151	<b>392,00 €</b>

<b>UNC - Unified Zollgewinde ANSI B1.1 - Lehrenmaße Gewindedorne ANSI B1.2 - Gewinderinge BS 919</b>											
7300110050	<b>GLD UNC NR. 1-64-2B</b> (0.073)	150	<b>110,00 €</b>	7300120050	<b>GD UNC NR. 1-64-2B</b>	150	<b>71,00 €</b>	7300130050	<b>AD UNC NR. 1-64-2B</b>	150	<b>71,00 €</b>
7300210050	<b>GLD UNC NR. 2-56-2B</b> (0.086)	150	<b>101,00 €</b>	7300220050	<b>GD UNC NR. 2-56-2B</b>	150	<b>65,00 €</b>	7300230050	<b>AD UNC NR. 2-56-2B</b>	150	<b>65,00 €</b>
7300310050	<b>GLD UNC NR. 3-48-2B</b> (0.099)	150	<b>93,00 €</b>	7300320050	<b>GD UNC NR. 3-48-2B</b>	150	<b>61,00 €</b>	7300330050	<b>AD UNC NR. 3-48-2B</b>	150	<b>61,00 €</b>
7300410050	<b>GLD UNC NR. 4-40-2B</b> (0.112)	150L	<b>91,00 €</b>	7300420050	<b>GD UNC NR. 4-40-2B</b>	150	<b>60,00 €</b>	7300430050	<b>AD UNC NR. 4-40-2B</b>	150	<b>60,00 €</b>
7300510050	<b>GLD UNC NR. 5-40-2B</b> (0.125)	150	<b>64,00 €</b>	7300520050	<b>GD UNC NR. 5-40-2B</b>	150	<b>59,00 €</b>	7300530050	<b>AD UNC NR. 5-40-2B</b>	150	<b>59,00 €</b>
7300610050	<b>GLD UNC NR. 6-32-2B</b> (0.138)	150L	<b>63,00 €</b>	7300620050	<b>GD UNC NR. 6-32-2B</b>	150	<b>57,00 €</b>	7300630050	<b>AD UNC NR. 6-32-2B</b>	150	<b>57,00 €</b>
7300710050	<b>GLD UNC NR. 8-32-2B</b> (0.164)	150L	<b>59,00 €</b>	7300720050	<b>GD UNC NR. 8-32-2B</b>	150	<b>54,00 €</b>	7300730050	<b>AD UNC NR. 8-32-2B</b>	150	<b>54,00 €</b>
7300810050	<b>GLD UNC NR.10-24-2B</b> (0.190)	150L	<b>57,00 €</b>	7300820050	<b>GD UNC NR.10-24-2B</b>	150	<b>53,00 €</b>	7300830050	<b>AD UNC NR.10-24-2B</b>	150	<b>53,00 €</b>
7300910050	<b>GLD UNC NR.12-24-2B</b> (0.216)	150L	<b>56,00 €</b>	7300920050	<b>GD UNC NR.12-24-2B</b>	150	<b>53,00 €</b>	7300930050	<b>AD UNC NR.12-24-2B</b>	150	<b>53,00 €</b>
7301010050	<b>GLD UNC 1/4-20-2B</b>	150L	<b>55,00 €</b>	7301020050	<b>GD UNC 1/4-20-2B</b>	150	<b>39,00 €</b>	7301030050	<b>AD UNC 1/4-20-2B</b>	150	<b>39,00 €</b>
7301110050	<b>GLD UNC 5/16-18-2B</b>	150L	<b>57,00 €</b>	7301120050	<b>GD UNC 5/16-18-2B</b>	150	<b>39,00 €</b>	7301130050	<b>AD UNC 5/16-18-2B</b>	150	<b>39,00 €</b>
7301210050	<b>GLD UNC 3/8-16-2B</b>	150L	<b>61,00 €</b>	7301220050	<b>GD UNC 3/8-16-2B</b>	150	<b>40,00 €</b>	7301230050	<b>AD UNC 3/8-16-2B</b>	150	<b>40,00 €</b>
7301310050	<b>GLD UNC 7/16-14-2B</b>	150	<b>62,00 €</b>	7301320050	<b>GD UNC 7/16-14-2B</b>	150	<b>42,00 €</b>	7301330050	<b>AD UNC 7/16-14-2B</b>	150	<b>42,00 €</b>
7301410050	<b>GLD UNC 1/2-13-2B</b>	150L	<b>66,00 €</b>	7301420050	<b>GD UNC 1/2-13-2B</b>	150	<b>36,00 €</b>	7301430050	<b>AD UNC 1/2-13-2B</b>	150	<b>44,00 €</b>
7301510050	<b>GLD UNC 9/16-12-2B</b>	150	<b>71,00 €</b>	7301520050	<b>GD UNC 9/16-12-2B</b>	150	<b>47,00 €</b>	7301530050	<b>AD UNC 9/16-12-2B</b>	150	<b>47,00 €</b>
7301610050	<b>GLD UNC 5/8-11-2B</b>	150L	<b>73,00 €</b>	7301620050	<b>GD UNC 5/8-11-2B</b>	150	<b>51,00 €</b>	7301630050	<b>AD UNC 5/8-11-2B</b>	150	<b>51,00 €</b>
7301710050	<b>GLD UNC 3/4-10-2B</b>	150	<b>84,00 €</b>	7301720050	<b>GD UNC 3/4-10-2B</b>	150	<b>58,00 €</b>	7301730050	<b>AD UNC 3/4-10-2B</b>	150	<b>58,00 €</b>
7301810050	<b>GLD UNC 7/8-9-2B</b>	150	<b>95,00 €</b>	7301820050	<b>GD UNC 7/8-9-2B</b>	150	<b>67,00 €</b>	7301830050	<b>AD UNC 7/8-9-2B</b>	150	<b>67,00 €</b>
7301910050	<b>GLD UNC 1 -8-2B</b>	150	<b>107,00 €</b>	7301920050	<b>GD UNC 1 -8-2B</b>	150	<b>75,00 €</b>	7301930050	<b>AD UNC 1 -8-2B</b>	150	<b>75,00 €</b>
7302010050	<b>GLD UNC 1 1/8-7-2B</b>	150	<b>120,00 €</b>	7302020050	<b>GD UNC 1 1/8-7-2B</b>	150	<b>108,00 €</b>	7302030050	<b>AD UNC 1 1/8-7-2B</b>	150	<b>108,00 €</b>
7302110050	<b>GLD UNC 1 1/4-7-2B</b>	150	<b>129,00 €</b>	7302120050	<b>GD UNC 1 1/4-7-2B</b>	150	<b>114,00 €</b>	7302130050	<b>AD UNC 1 1/4-7-2B</b>	150	<b>114,00 €</b>
7302210050	<b>GLD UNC 1 3/8-6-2B</b>	150	<b>150,00 €</b>	7302220050	<b>GD UNC 1 3/8-6-2B</b>	150	<b>127,00 €</b>	7302230050	<b>AD UNC 1 3/8-6-2B</b>	150	<b>127,00 €</b>
7302310050	<b>GLD UNC 1 1/2-6-2B</b>	150	<b>166,00 €</b>	7302320050	<b>GD UNC 1 1/2-6-2B</b>	150	<b>141,00 €</b>	7302330050	<b>AD UNC 1 1/2-6-2B</b>	150	<b>141,00 €</b>
				7302420051	<b>GD UNC 1 3/4-5-2B</b>	151	<b>91,00 €</b>	7302430051	<b>AD UNC 1 3/4-5-2B</b>	151	<b>91,00 €</b>
				7302520051	<b>GD UNC 2 -4 1/2-2B</b>	151	<b>106,00 €</b>	7302530051	<b>AD UNC 2 -4 1/2-2B</b>	151	<b>106,00 €</b>
				7302620051	<b>GD UNC 2 1/4-4 1/2-2B</b>	151	<b>120,00 €</b>	7302630051	<b>AD UNC 2 1/4-4 1/2-2B</b>	151	<b>120,00 €</b>
				7302720051	<b>GD UNC 2 1/2-4-2B</b>	151	<b>134,00 €</b>	7302730051	<b>AD UNC 2 1/2-4-2B</b>	151	<b>134,00 €</b>
				7302820051	<b>GD UNC 2 3/4-4-2B</b>	151	<b>149,00 €</b>	7302830051	<b>AD UNC 2 3/4-4-2B</b>	151	<b>149,00 €</b>
				7302920051	<b>GD UNC 3 -4-2B</b>	151	<b>163,00 €</b>	7302930051	<b>AD UNC 3 -4-2B</b>	151	<b>163,00 €</b>
				7303020051	<b>GD UNC 3 1/4-4-2B</b>	151	<b>177,00 €</b>	7303030051	<b>AD UNC 3 1/4-4-2B</b>	151	<b>177,00 €</b>
				7303120051	<b>GD UNC 3 1/2-4-2B</b>	151	<b>191,00 €</b>	7303130051	<b>AD UNC 3 1/2-4-2B</b>	151	<b>191,00 €</b>

Anr.	Beschreibung	AGr.	Einzelpreis	Anr.	Beschreibung	AGr.	Einzelpreis	Anr.	Beschreibung	AGr.	Einzelpreis
<b>UNC - Unified Zollgewinde ANSI B1.1 - Lehrenmaße Gewindedorne ANSI B1.2 - Gewinderinge BS 919</b>											
				7303220051	<b>GD UNC 3 3/4-4-2B</b>	151	<b>206,00 €</b>	7303230051	<b>AD UNC 3 3/4-4-2B</b>	151	<b>206,00 €</b>
				7303320051	<b>GD UNC 4 -4-2B</b>	151	<b>220,00 €</b>	7303330051	<b>AD UNC 4 -4-2B</b>	151	<b>220,00 €</b>

<b>UNF - Unified Zollgewinde ANSI B1.1 - Lehrenmaße Gewindedorne ANSI B1.2 - Gewinderinge BS 919</b>											
7400110050	<b>GLD UNF NR. 0-80 UNF-2B</b>	150	<b>119,00 €</b>	7400120050	<b>GD UNF NR. 0-80-2B</b>	150	<b>58,00 €</b>	7400130050	<b>AD UNF NR. 0-80-2B</b>	150	<b>58,00 €</b>
7400210050	<b>GLD UNF NR. 1-72-2B (0.073)</b>	150	<b>90,00 €</b>	7400220050	<b>GD UNF NR. 1-72-2B</b>	150	<b>50,00 €</b>	7400230050	<b>AD UNF NR. 1-72-2B</b>	150	<b>50,00 €</b>
7400310050	<b>GLD UNF NR. 2-64-2B (0.086)</b>	150	<b>84,00 €</b>	7400320050	<b>GD UNF NR. 2-64-2</b>	150	<b>46,00 €</b>	7400330050	<b>AD UNF NR. 2-64-2B</b>	150	<b>46,00 €</b>
7400410050	<b>GLD UNF NR. 3-56-2B (0.099)</b>	150	<b>79,00 €</b>	7400420050	<b>GD UNF NR. 3-56-2B</b>	150	<b>43,00 €</b>	7400430050	<b>AD UNF NR. 3-56-2B</b>	150	<b>43,00 €</b>
7400510050	<b>GLD UNF NR. 4-48-2B (0.112)</b>	150	<b>74,00 €</b>	7400520050	<b>GD UNF NR. 4-48-2B</b>	150	<b>41,00 €</b>	7400530050	<b>AD UNF NR. 4-48-2B</b>	150	<b>41,00 €</b>
7400610050	<b>GLD UNF NR. 5-44-2B (0.125)</b>	150	<b>64,00 €</b>	7400620050	<b>GD UNF NR. 5-44-2B</b>	150	<b>35,00 €</b>	7400630050	<b>AD UNF NR. 5-44-2B</b>	150	<b>35,00 €</b>
7400710050	<b>GLD UNF NR. 6-40-2B (0.138)</b>	150	<b>63,00 €</b>	7400720050	<b>GD UNF NR. 6-40-2B</b>	150	<b>35,00 €</b>	7400730050	<b>AD UNF NR. 6-40-2B</b>	150	<b>35,00 €</b>
7400810050	<b>GLD UNF NR. 8-36-2B (0.164)</b>	150	<b>59,00 €</b>	7400820050	<b>GD UNF NR. 8-36-2B</b>	150	<b>32,00 €</b>	7400830050	<b>AD UNF NR. 8-36-2B</b>	150	<b>32,00 €</b>
7400910050	<b>GLD UNF NR.10-32-2B (0.190)</b>	150L	<b>57,00 €</b>	7400920050	<b>GD UNF NR.10-32-2B</b>	150	<b>31,00 €</b>	7400930050	<b>AD UNF NR.10-32-2B</b>	150	<b>31,00 €</b>
7401010050	<b>GLD UNF NR.12-28-2B (0.216)</b>	150L	<b>57,00 €</b>	7401020050	<b>GD UNF NR.12-28-2B</b>	150	<b>31,00 €</b>	7401030050	<b>AD UNF NR.12-28-2B</b>	150	<b>31,00 €</b>
7401110050	<b>GLD UNF 1/4-28-2B</b>	150L	<b>55,00 €</b>	7401120050	<b>GD UNF 1/4-28-2B</b>	150	<b>30,00 €</b>	7401130050	<b>AD UNF 1/4-28-2B</b>	150	<b>30,00 €</b>
7401210050	<b>GLD UNF 5/16-24-2B</b>	150L	<b>57,00 €</b>	7401220050	<b>GD UNF 5/16-24-2B</b>	150	<b>31,00 €</b>	7401230050	<b>AD UNF 5/16-24-2B</b>	150	<b>31,00 €</b>
7401310050	<b>GLD UNF 3/8-24-2B</b>	150L	<b>58,00 €</b>	7401320050	<b>GD UNF 3/8-24-2B</b>	150	<b>32,00 €</b>	7401330050	<b>AD UNF 3/8-24-2B</b>	150	<b>32,00 €</b>
7401410050	<b>GLD UNF 7/16-20-2B</b>	150L	<b>62,00 €</b>	7401420050	<b>GD UNF 7/16-20-2B</b>	150	<b>34,00 €</b>	7401430050	<b>AD UNF 7/16-20-2B</b>	150	<b>34,00 €</b>
7401510050	<b>GLD UNF 1/2-20-2B</b>	150L	<b>66,00 €</b>	7401520050	<b>GD UNF 1/2-20-2B</b>	150	<b>36,00 €</b>	7401530050	<b>AD UNF 1/2-20-2B</b>	150	<b>36,00 €</b>
7401610050	<b>GLD UNF 9/16-18-2B</b>	150L	<b>69,00 €</b>	7401620050	<b>GD UNF 9/16-18-2B</b>	150	<b>38,00 €</b>	7401630050	<b>AD UNF 9/16-18-2B</b>	150	<b>38,00 €</b>
7401710050	<b>GLD UNF 5/8-18-2B</b>	150L	<b>71,00 €</b>	7401720050	<b>GD UNF 5/8-18-2B</b>	150	<b>39,00 €</b>	7401730050	<b>AD UNF 5/8-18-2B</b>	150	<b>39,00 €</b>
7401810050	<b>GLD UNF 3/4-16-2B</b>	150L	<b>78,00 €</b>	7401820050	<b>GD UNF 3/4-16-2B</b>	150	<b>43,00 €</b>	7401830050	<b>AD UNF 3/4-16-2B</b>	150	<b>43,00 €</b>
7401910050	<b>GLD UNF 7/8-14-2B</b>	150	<b>87,00 €</b>	7401920050	<b>GD UNF 7/8-14-2B</b>	150	<b>48,00 €</b>	7401930050	<b>AD UNF 7/8-14-2B</b>	150	<b>48,00 €</b>
7402010050	<b>GLD UNF 1 -12-2B</b>	150	<b>97,00 €</b>	7402020050	<b>GD UNF 1 -12-2B</b>	150	<b>53,00 €</b>	7402030050	<b>AD UNF 1 -12-2B</b>	150	<b>53,00 €</b>
7402110050	<b>GLD UNF 1 1/8-12-2B</b>	150	<b>107,00 €</b>	7402120050	<b>GD UNF 1 1/8-12-2B</b>	150	<b>59,00 €</b>	7402130050	<b>AD UNF 1 1/8-12-2B</b>	150	<b>59,00 €</b>
7402210050	<b>GLD UNF 1 1/4-12-2B</b>	150	<b>113,00 €</b>	7402220050	<b>GD UNF 1 1/4-12-2B</b>	150	<b>62,00 €</b>	7402230050	<b>AD UNF 1 1/4-12-2B</b>	150	<b>62,00 €</b>
7402310050	<b>GLD UNF 1 3/8-12-2B</b>	150	<b>131,00 €</b>	7402320050	<b>GD UNF 1 3/8-12-2B</b>	150	<b>72,00 €</b>	7402330050	<b>AD UNF 1 3/8-12-2B</b>	150	<b>72,00 €</b>
7402410050	<b>GLD UNF 1 1/2-12-2B</b>	150	<b>143,00 €</b>	7402420050	<b>GD UNF 1 1/2-12-2B</b>	150	<b>79,00 €</b>	7402430050	<b>AD UNF 1 1/2-12-2B</b>	150	<b>79,00 €</b>

<b>UNEF - Unified Zollgewinde ANSI B1.1 - Lehrenmaße Gewindedorne ANSI B1.2 - Gewinderinge BS 919</b>											
7940110050	<b>GLD UNEF NR.12-32-2B (0.216)</b>	150	<b>63,00 €</b>	7940120050	<b>GD UNEF NR.12-32-2B</b>	150	<b>35,00 €</b>	7940130050	<b>AD UNEF NR.12-32-2B</b>	150	<b>35,00 €</b>
7940210050	<b>GLD UNEF 1/4-32-2B</b>	150	<b>63,00 €</b>	7940220050	<b>GD UNEF 1/4-32-2B</b>	150	<b>35,00 €</b>	7940230050	<b>AD 1/4-32 UNEF-2B</b>	150	<b>35,00 €</b>
7940310050	<b>GLD UNEF 5/16-32-2B</b>	150	<b>66,00 €</b>	7940320050	<b>GD UNEF 5/16-32-2B</b>	150	<b>36,00 €</b>	7940330050	<b>AD UNEF 5/16-32-2B</b>	150	<b>36,00 €</b>
7940410050	<b>GLD UNEF 3/8-32-2B</b>	150	<b>67,00 €</b>	7940420050	<b>GD UNEF 3/8-32-2B</b>	150	<b>37,00 €</b>	7940430050	<b>AD UNEF 3/8-32-2B</b>	150	<b>37,00 €</b>
7940510050	<b>GLD UNEF 7/16-28-2B</b>	150	<b>69,00 €</b>	7940520050	<b>GD UNEF 7/16-28-2B</b>	150	<b>38,00 €</b>	7940530050	<b>AD UNEF 7/16-28-2B</b>	150	<b>38,00 €</b>
7940610050	<b>GLD UNEF 1/2-28-2B</b>	150	<b>70,00 €</b>	7940620050	<b>GD UNEF 1/2-28-2B</b>	150	<b>39,00 €</b>	7940630050	<b>AD UNEF 1/2-28-2B</b>	150	<b>39,00 €</b>
7940710050	<b>GLD UNEF 9/16-24-2B</b>	150	<b>74,00 €</b>	7940720050	<b>GD UNEF 9/16-24-2B</b>	150	<b>41,00 €</b>	7940730050	<b>AD UNEF 9/16-24-2B</b>	150	<b>41,00 €</b>
7940810050	<b>GLD UNEF 5/8-24-2B</b>	150	<b>76,00 €</b>	7940820050	<b>GD UNEF 5/8-24-2B</b>	150	<b>39,00 €</b>	7940830050	<b>AD UNEF 5/8-24-2B</b>	150	<b>39,00 €</b>
7940910050	<b>GLD UNEF 11/16-24-2B</b>	150	<b>80,00 €</b>	7940920050	<b>GD UNEF 11/16-24-2B</b>	150	<b>42,00 €</b>	7940930050	<b>AD UNEF 11/16-24-2B</b>	150	<b>42,00 €</b>
7941010050	<b>GLD UNEF 3/4-20-2B</b>	150	<b>81,00 €</b>	7941020050	<b>GD UNEF 3/4-20-2B</b>	150	<b>44,00 €</b>	7941030050	<b>AD UNEF 3/4-20-2B</b>	150	<b>44,00 €</b>
7941110050	<b>GLD UNEF 13/16-20-2B</b>	150	<b>86,00 €</b>	7941120050	<b>GD UNEF 13/16-20-2B</b>	150	<b>47,00 €</b>	7941130050	<b>AD UNEF 13/16-20-2B</b>	150	<b>47,00 €</b>
7941210050	<b>GLD UNEF 7/8-20-2B</b>	150	<b>90,00 €</b>	7941220050	<b>GD UNEF 7/8-20-2B</b>	150	<b>50,00 €</b>	7941230050	<b>AD UNEF 7/8-20-2B</b>	150	<b>50,00 €</b>

ANr.	Beschreibung	AGr.	Einzelpreis	ANr.	Beschreibung	AGr.	Einzelpreis	ANr.	Beschreibung	AGr.	Einzelpreis
<b>UNEF - Unified Zollgewinde ANSI B1.1 - Lehrenmaße Gewindedorne ANSI B1.2 - Gewinderinge BS 919</b>											
7941310050	<b>GLD UNEF 15/16-20-2B</b>	150	<b>94,00 €</b>	7941320050	<b>GD UNEF 15/16-20-2B</b>	150	<b>52,00 €</b>	7941330050	<b>AD UNEF 15/16-20-2B</b>	150	<b>52,00 €</b>
7941410050	<b>GLD UNEF 1-20-2B</b>	150	<b>97,00 €</b>	7941420050	<b>GD UNEF 1-20-2B</b>	150	<b>53,00 €</b>	7941430050	<b>AD UNEF 1-20-2B</b>	150	<b>53,00 €</b>
7941510050	<b>GLD UNEF 1 1/16-18-2B</b>	150	<b>103,00 €</b>	7941520050	<b>GD UNEF 1 1/16-18-2B</b>	150	<b>57,00 €</b>	7941530050	<b>AD UNEF 1 1/16-18-2B</b>	150	<b>57,00 €</b>
7941610050	<b>GLD UNEF 1 1/8-18-2B</b>	150	<b>107,00 €</b>	7941620050	<b>GD UNEF 1 1/8-18-2B</b>	150	<b>59,00 €</b>	7941630050	<b>AD UNEF 1 1/8-18-2B</b>	150	<b>59,00 €</b>
7941710050	<b>GLD UNEF 1 3/16-18-2B</b>	150	<b>114,00 €</b>	7941720050	<b>GD UNEF 1 3/16-18-2B</b>	150	<b>63,00 €</b>	7941730050	<b>AD UNEF 1 3/16-18-2B</b>	150	<b>63,00 €</b>
7941810050	<b>GLD UNEF 1 1/4-18-2B</b>	150	<b>117,00 €</b>	7941820050	<b>GD UNEF 1 1/4-18-2B</b>	150	<b>64,00 €</b>	7941830050	<b>AD 1 1/4-18 UNEF-2B</b>	150	<b>64,00 €</b>
7941910050	<b>GLD UNEF 1 5/16-18-2B</b>	150	<b>120,00 €</b>	7941920050	<b>GD UNEF 1 5/16-18-2B</b>	150	<b>66,00 €</b>	7941930050	<b>AD UNEF 1 5/16-18-2B</b>	150	<b>66,00 €</b>
7942010050	<b>GLD UNEF 1 3/8-18-2B</b>	150	<b>133,00 €</b>	7942020050	<b>GD UNEF 1 3/8-18-2B</b>	150	<b>73,00 €</b>	7942030050	<b>AD UNEF 1 3/8-18-2B</b>	150	<b>73,00 €</b>
7942110050	<b>GLD UNEF 1 7/16-18-2</b>	150	<b>139,00 €</b>	7942120050	<b>GD UNEF 1 7/16-18-2B</b>	150	<b>76,00 €</b>	7942130050	<b>AD UNEF 1 7/16-18-2B</b>	150	<b>76,00 €</b>
7942210050	<b>GLD UNEF 1 1/2-18-2B</b>	150	<b>144,00 €</b>	7942220050	<b>GD UNEF 1 1/2-18-2B</b>	150	<b>79,00 €</b>	7942230050	<b>AD UNEF 1 1/2-18-2B</b>	150	<b>79,00 €</b>
7942310050	<b>GLD UNEF 1 9/16-18-2B</b>	150	<b>149,00 €</b>	7942320050	<b>GD UNEF 1 9/16-18-2B</b>	150	<b>82,00 €</b>	7942330050	<b>AD UNEF 1 9/16-18-2B</b>	150	<b>82,00 €</b>
				7942420051	<b>GD UNEF 1 5/8-18-2B</b>	151	<b>71,00 €</b>	7942430051	<b>AD UNEF 1 5/8-18-2B</b>	151	<b>71,00 €</b>
				7942520051	<b>GD UNEF 1 11/16-18-2B</b>	151	<b>76,00 €</b>	7942530051	<b>AD UNEF 1 11/16-18-2B</b>	151	<b>76,00 €</b>

Anr.	Beschreibung	AGr.	Einzelpreis	Anr.	Beschreibung	AGr.	Einzelpreis	Anr.	Beschreibung	AGr.	Einzelpreis
------	--------------	------	-------------	------	--------------	------	-------------	------	--------------	------	-------------

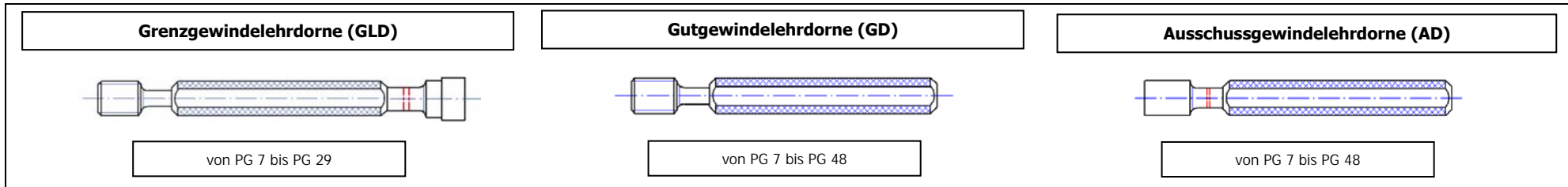

Stahlpanzerrohrgewinde DIN 40430											
7600110050	<b>GLD PG 7 DIN 40430</b>	150L	<b>61,00 €</b>	7600120050	<b>GD PG 7 DIN 40430</b>	150	<b>46,00 €</b>	7600130050	<b>AD PG 7 DIN 40430</b>	150	<b>22,00 €</b>
7600210050	<b>GLD PG 9 DIN 40430</b>	150L	<b>67,00 €</b>	7600220050	<b>GD PG 9 DIN 40430</b>	150	<b>50,00 €</b>	7600230050	<b>AD PG 9 DIN 40430</b>	150	<b>24,00 €</b>
7600310050	<b>GLD PG 11 DIN 40430</b>	150L	<b>77,00 €</b>	7600320050	<b>GD PG 11 DIN 40430</b>	150	<b>58,00 €</b>	7600330050	<b>AD PG 11 DIN 40430</b>	150	<b>27,00 €</b>
7600410050	<b>GLD PG 13,5 DIN 40430</b>	150L	<b>81,00 €</b>	7600420050	<b>GD PG 13,5 DIN 40430</b>	150	<b>61,00 €</b>	7600430050	<b>AD PG 13,5 DIN 40430</b>	150	<b>29,00 €</b>
7600510050	<b>GLD PG 16 DIN 40430</b>	150L	<b>87,00 €</b>	7600520050	<b>GD PG 16 DIN 40430</b>	150	<b>65,00 €</b>	7600530050	<b>AD PG 16 DIN 40430</b>	150	<b>31,00 €</b>
7600610050	<b>GLD PG 21 DIN 40430</b>	150L	<b>104,00 €</b>	7600620050	<b>GD PG 21 DIN 40430</b>	150	<b>78,00 €</b>	7600630050	<b>AD PG 21 DIN 40430</b>	150	<b>37,00 €</b>
7600710050	<b>GLD PG 29 DIN 40430</b>	150L	<b>139,00 €</b>	7600720050	<b>GD PG 29 DIN 40430</b>	150	<b>104,00 €</b>	7600730050	<b>AD PG 29 DIN 40430</b>	150	<b>49,00 €</b>
				7600820051	<b>GD PG 36 DIN 40430</b>	151	<b>144,00 €</b>	7600830051	<b>AD PG 36 DIN 40430</b>	151	<b>80,00 €</b>
				7600920051	<b>GD PG 42 DIN 40430</b>	151	<b>164,00 €</b>	7600930051	<b>AD PG 42 DIN 40430</b>	151	<b>91,00 €</b>
				7601020051	<b>GD PG 48 DIN 40430</b>	151	<b>179,00 €</b>	7601030051	<b>AD PG 48 DIN 40430</b>	151	<b>99,00 €</b>

Elektrogewinde DIN 40400											
7680110050	<b>GLD E 5 DIN 40400</b>	150	<b>338,00 €</b>	7680120050	<b>GD E 5 DIN 40400</b>	150	<b>271,00 €</b>	7680130050	<b>AD E 5 DIN 40400</b>	150	<b>68,00 €</b>
7680210050	<b>GLD E 10 DIN 40400</b>	150	<b>338,00 €</b>	7680220050	<b>GD E 10 DIN 40400</b>	150	<b>271,00 €</b>	7680230050	<b>AD E 10 DIN 40400</b>	150	<b>68,00 €</b>
7680310050	<b>GLD E 14 DIN 40400</b>	150	<b>208,00 €</b>	7680320050	<b>GD E 14 DIN 40400</b>	150	<b>156,00 €</b>	7680330050	<b>AD E 14 DIN 40400</b>	150	<b>73,00 €</b>
7680410050	<b>GLD E 16 DIN 40400</b>	150	<b>219,00 €</b>	7680420050	<b>GD E 16 DIN 40400</b>	150	<b>165,00 €</b>	7680430050	<b>AD E 16 DIN 40400</b>	150	<b>77,00 €</b>
7680510050	<b>GLD E 18 DIN 40400</b>	150	<b>239,00 €</b>	7680520050	<b>GD E 18 DIN 40400</b>	150	<b>180,00 €</b>	7680530050	<b>AD E 18 DIN 40400</b>	150	<b>84,00 €</b>
7680610050	<b>GLD E 27 DIN 40400</b>	150	<b>303,00 €</b>	7680620050	<b>GD E 27 DIN 40400</b>	150	<b>227,00 €</b>	7680630050	<b>AD E 27 DIN 40400</b>	150	<b>106,00 €</b>
7680710050	<b>GLD E 33 DIN 40400</b>	150	<b>330,00 €</b>	7680720050	<b>GD E 33 DIN 40400</b>	150	<b>248,00 €</b>	7680730050	<b>AD E 33 DIN 40400</b>	150	<b>116,00 €</b>
7680810050	<b>GLD E 40 DIN 40400</b>	150	<b>845,00 €</b>	7680820050	<b>GD E 40 DIN 40400</b>	150	<b>676,00 €</b>	7680830050	<b>AD E 40 DIN 40400</b>	150	<b>170,00 €</b>

ANr.	Beschreibung	AGr.	Einzelpreis	ANr.	Beschreibung	AGr.	Einzelpreis	ANr.	Beschreibung	AGr.	Einzelpreis
------	--------------	------	-------------	------	--------------	------	-------------	------	--------------	------	-------------

**Grenzwindelehrdorne (GLD)**

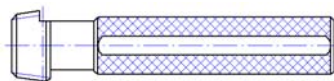

**Whitworth Rohrgewinde DIN 2999 - Gewindegrenzlehrdorne keglig - Gewindegrenzlehrringe zylindrisch**

7700120050	<b>GLD RP 1/8 DIN 2999</b>	150L	<b>146,00 €</b>
7700220050	<b>GLD RP 1/4 DIN 2999</b>	150L	<b>154,00 €</b>
7700320050	<b>GLD RP 3/8 DIN 2999</b>	150L	<b>160,00 €</b>
7700420050	<b>GLD RP 1/2 DIN 2999</b>	150L	<b>180,00 €</b>
7700520050	<b>GLD RP 3/4 DIN 2999</b>	150L	<b>203,00 €</b>
7700620050	<b>GLD RP 1 DIN 2999</b>	150L	<b>234,00 €</b>
7700720051	<b>GLD RP 1 1/4 DIN 2999</b>	150	<b>280,00 €</b>
7700820051	<b>GLD RP 1 1/2 DIN 2999</b>	150L	<b>314,00 €</b>
7700920051	<b>GLD RP 2 DIN 2999</b>	150L	<b>389,00 €</b>
7701020051	<b>GLD RP 2 1/2 DIN 2999</b>	150L	<b>443,00 €</b>
7701120051	<b>GLD RP 3 DIN 2999</b>	150	<b>540,00 €</b>
7701220051	<b>GLD RP 4 DIN 2999</b>	150	<b>697,00 €</b>
7701320051	<b>GLD RP 5 DIN 2999</b>	150	<b>857,00 €</b>
7701420051	<b>GLD RP 6 DIN 2999</b>	150	<b>1.031,00 €</b>



**Kegeliges Amerikanisches Rohrgewinde NPT - Gewindegrenzlehrdorne keglig - Gewindegrenzlehrringe keglig**

7500120050	<b>GLD NPT 1/16-27</b>	150	<b>140,00 €</b>
7500220050	<b>GLD NPT 1/8-27</b>	150L	<b>146,00 €</b>
7500320050	<b>GLD NPT 1/4-18</b>	150L	<b>154,00 €</b>
7500420050	<b>GLD NPT 3/8-18</b>	150L	<b>166,00 €</b>
7500520050	<b>GLD NPT 1/2-14</b>	150L	<b>180,00 €</b>
7500620050	<b>GLD NPT 3/4-14</b>	150L	<b>200,00 €</b>
7500720050	<b>GLD NPT 1-11 1/2</b>	150L	<b>231,00 €</b>
7500820051	<b>GLD NPT 1 1/4-11 1/2</b>	150	<b>280,00 €</b>
7500920051	<b>GLD NPT 1 1/2-11 1/2</b>	150L	<b>314,00 €</b>
7501020051	<b>GLD NPT 2-11 1/2</b>	150L	<b>389,00 €</b>
7501120051	<b>GLD NPT 2 1/2-8</b>	150	<b>443,00 €</b>
7501220051	<b>GLD NPT 3-8</b>	150	<b>540,00 €</b>
7501320051	<b>GLD NPT 3 1/2-8</b>	150	<b>611,00 €</b>
7501420051	<b>GLD NPT 4-8</b>	150	<b>694,00 €</b>
7501520051	<b>GLD NPT 5-8</b>	150	<b>854,00 €</b>
7501620051	<b>GLD NPT 6-8</b>	150	<b>1.031,00 €</b>

ANr.	Beschreibung	AGr.	Einzelpreis	ANr.	Beschreibung	AGr.	Einzelpreis	ANr.	Beschreibung	AGr.	Einzelpreis
<b>Kegeliges Amerikanisches Rohrgewinde NPTF · Gewindegrenzlehndorne keglig · Gewindegrenzlehring keglig</b>											
7500121050	<b>GLD NPTF 1/16-27 (L1)</b>	150	<b>140,00 €</b>								
7500221050	<b>GLD NPTF 1/8-27 (L1)</b>	150	<b>146,00 €</b>								
7500321050	<b>GLD NPTF 1/4-18 (L1)</b>	150	<b>154,00 €</b>								
7500421050	<b>GLD NPTF 3/8-18 (L1)</b>	150	<b>166,00 €</b>								
7500521050	<b>GLD NPTF 1/2-14 (L1)</b>	150	<b>180,00 €</b>								
7500621050	<b>GLD NPTF 3/4-14 (L1)</b>	150	<b>200,00 €</b>								
7500721050	<b>GLD NPTF 1-11 1/2 (L1)</b>	150	<b>231,00 €</b>								
7500821051	<b>GLD NPTF 1 1/4-11 1/2 (L1)</b>	150	<b>280,00 €</b>								
7500921051	<b>GLD NPTF 1 1/2-11 1/2 (L1)</b>	150	<b>314,00 €</b>								
7501021051	<b>GLD NPTF 2-11 1/2 (L1)</b>	150	<b>389,00 €</b>								
7501121051	<b>GLD NPTF 2 1/2-8 (L1)</b>	150	<b>443,00 €</b>								
7501221051	<b>GLD NPTF 3-8 (L1)</b>	150	<b>540,00 €</b>								
7501321051	<b>GLD NPTF 3 1/2-8 (L1)</b>	150	<b>864,00 €</b>								
7501421051	<b>GLD NPTF 4-8 (L1)</b>	150	<b>1.037,00 €</b>								
7501521051	<b>GLD NPTF 5-8 (L1)</b>	150	<b>1.244,00 €</b>								
7501621051	<b>GLD NPTF 6-8 (L1)</b>	150	<b>1.493,00 €</b>								

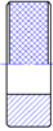
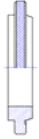
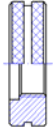

ANr.	Beschreibung	AGr.	Einzelpreis	ANr.	Beschreibung	AGr.	Einzelpreis
------	--------------	------	-------------	------	--------------	------	-------------

Gut-Gewindelehrringe (GR)		Ausschuss-Gewindelehrringe (AR)	
			
von Nenndurchmesser 1 bis 100 mm		und über 100 mm	
von Nenndurchmesser 1 bis 100 mm		und über 100 mm	

Metrisches Regelgewinde DIN ISO 13							
91A00100A1B	<b>GR M 1-6h</b>	91	<b>130,00 €</b>	92A00100A1B	<b>AR M 1-6h</b>	92	<b>130,00 €</b>
91A00120A1B	<b>GR M 1,2-6h</b>	91	<b>123,00 €</b>	92A00120A1B	<b>AR M 1,2-6h</b>	92	<b>123,00 €</b>
91A00140B1B	<b>GR M 1,4-6h</b>	91	<b>113,00 €</b>	92A00140B1B	<b>AR M 1,4-6h</b>	92	<b>113,00 €</b>
91A00160C1D	<b>GR M 1,6-6g</b>	91	<b>100,00 €</b>	92A00160C1D	<b>AR M 1,6-6g</b>	92	<b>100,00 €</b>
91A00180C1D	<b>GR M 1,8-6g</b>	91	<b>89,00 €</b>	92A00180C1D	<b>AR M 1,8-6g</b>	92	<b>89,00 €</b>
91A00200D1D	<b>GR M 2-6g</b>	91L	<b>89,00 €</b>	92A00200D1D	<b>AR M 2-6g</b>	92L	<b>89,00 €</b>
91A00220E1D	<b>GR M 2,2-6g</b>	91	<b>78,00 €</b>	92A00220E1D	<b>AR M 2,2-6g</b>	92	<b>78,00 €</b>
91A00230E1D	<b>GR M 2,3-6g</b>	91	<b>78,00 €</b>	92A00230E1D	<b>AR M 2,3-6g</b>	92	<b>78,00 €</b>
91A00250E1D	<b>GR M 2,5-6g</b>	91L	<b>67,00 €</b>	92A00250E1D	<b>AR M 2,5-6g</b>	92L	<b>67,00 €</b>
91A00300F1D	<b>GR M 3-6g</b>	91L	<b>52,00 €</b>	92A00300F1D	<b>AR M 3-6g</b>	92L	<b>52,00 €</b>
91A00350G1D	<b>GR M 3,5-6g</b>	91L	<b>49,00 €</b>	92A00350G1D	<b>AR M 3,5-6g</b>	92L	<b>49,00 €</b>
91A00400H1D	<b>GR M 4-6g</b>	91L	<b>48,00 €</b>	92A00400H1D	<b>AR M 4-6g</b>	92L	<b>48,00 €</b>
91A00450I1D	<b>GR M 4,5-6g</b>	91	<b>58,00 €</b>	92A00450I1D	<b>AR M 4,5-6g</b>	92	<b>58,00 €</b>
91A00500J1D	<b>GR M 5-6g</b>	91L	<b>48,00 €</b>	92A00500J1D	<b>AR M 5-6g</b>	92L	<b>48,00 €</b>
91A00600K1D	<b>GR M 6-6g</b>	91L	<b>48,00 €</b>	92A00600K1D	<b>AR M 6-6g</b>	92L	<b>48,00 €</b>
91A00700K1D	<b>GR M 7-6g</b>	91	<b>58,00 €</b>	92A00700K1D	<b>AR M 7-6g</b>	92	<b>58,00 €</b>
91A00800L1D	<b>GR M 8-6g</b>	91L	<b>49,00 €</b>	92A00800L1D	<b>AR M 8-6g</b>	92L	<b>49,00 €</b>
91A00900L1D	<b>GR M 9-6g</b>	91	<b>64,00 €</b>	92A00900L1D	<b>AR M 9-6g</b>	92	<b>64,00 €</b>
91A01000M1D	<b>GR M 10-6g</b>	91L	<b>57,00 €</b>	92A01000M1D	<b>AR M 10-6g</b>	92L	<b>57,00 €</b>
91A01100M1D	<b>GR M 11-6g</b>	91	<b>75,00 €</b>	92A01100M1D	<b>AR M 11-6g</b>	92	<b>75,00 €</b>
91A01200N1D	<b>GR M 12-6g</b>	91L	<b>66,00 €</b>	92A01200N1D	<b>AR M 12-6g</b>	92L	<b>66,00 €</b>
0014040053	<b>GR M 14-6g</b>	153L	<b>61,00 €</b>	0014050053	<b>AR M 14-6g</b>	153L	<b>61,00 €</b>
0016040053	<b>GR M 16-6g</b>	153L	<b>68,00 €</b>	0016050053	<b>AR M 16-6g</b>	153L	<b>68,00 €</b>
0018040053	<b>GR M 18-6g</b>	153L	<b>78,00 €</b>	0018050053	<b>AR M 18-6g</b>	153L	<b>78,00 €</b>
0020040053	<b>GR M 20-6g</b>	153L	<b>84,00 €</b>	0020050053	<b>AR M 20-6g</b>	153L	<b>84,00 €</b>
0022040053	<b>GR M 22-6g</b>	153L	<b>91,00 €</b>	0022050053	<b>AR M 22-6g</b>	153L	<b>91,00 €</b>
0024040053	<b>GR M 24-6g</b>	153L	<b>98,00 €</b>	0024050053	<b>AR M 24-6g</b>	153L	<b>98,00 €</b>
0027040053	<b>GR M 27-6g</b>	153L	<b>108,00 €</b>	0027050053	<b>AR M 27-6g</b>	153L	<b>108,00 €</b>
0030040053	<b>GR M 30-6g</b>	153L	<b>120,00 €</b>	0030050053	<b>AR M 30-6g</b>	153L	<b>120,00 €</b>
0033040053	<b>GR M 33-6g</b>	153L	<b>130,00 €</b>	0033050053	<b>AR M 33-6g</b>	153L	<b>130,00 €</b>
0036040053	<b>GR M 36-6g</b>	153L	<b>141,00 €</b>	0036050053	<b>AR M 36-6g</b>	153L	<b>141,00 €</b>
0039040053	<b>GR M 39-6g</b>	153L	<b>155,00 €</b>	0039050053	<b>AR M 39-6g</b>	153L	<b>155,00 €</b>

ANr.	Beschreibung	AGr.	Einzelpreis	ANr.	Beschreibung	AGr.	Einzelpreis
<b>Metrisches Regelgewinde DIN ISO 13</b>							
0042040053	<b>GR M 42-6g</b>	153L	<b>164,00 €</b>	0042050053	<b>AR M 42-6g</b>	153L	<b>164,00 €</b>
0045040053	<b>GR M 45-6g</b>	153L	<b>174,00 €</b>	0045050053	<b>AR M 45-6g</b>	153L	<b>174,00 €</b>
0048040053	<b>GR M 48-6g</b>	153L	<b>184,00 €</b>	0048050053	<b>AR M 48-6g</b>	153L	<b>184,00 €</b>
0052040053	<b>GR M 52-6g</b>	153L	<b>197,00 €</b>	0052050053	<b>AR M 52-6g</b>	153L	<b>197,00 €</b>
0056040053	<b>GR M 56-6g</b>	153L	<b>212,00 €</b>	0056050053	<b>AR M 56-6g</b>	153L	<b>212,00 €</b>
0060040053	<b>GR M 60-6g</b>	153	<b>240,00 €</b>	0060050053	<b>AR M 60-6g</b>	153	<b>240,00 €</b>
0064040053	<b>GR M 64-6g</b>	153	<b>270,00 €</b>	0064050053	<b>AR M 64-6g</b>	153	<b>270,00 €</b>
0068040053	<b>GR M 68-6g</b>	153	<b>286,00 €</b>	0068050053	<b>AR M 68-6g</b>	153	<b>286,00 €</b>

<b>Metrisches Feingewinde DIN ISO 13 - Steigung 0.35</b>							
91C00200C1D	<b>GR M 2X0,35-6g</b>	91	<b>137,00 €</b>	92C00200C1D	<b>AR M 2X0,35-6g</b>	92	<b>137,00 €</b>
91C00220C1D	<b>GR M 2,2X0,35-6g</b>	91	<b>123,00 €</b>	92C00220C1D	<b>AR M 2,2X0,35-6g</b>	92	<b>123,00 €</b>
91C00250C1D	<b>GR M 2,5X0,35-6g</b>	91	<b>113,00 €</b>	92C00250C1D	<b>AR M 2,5X0,35-6g</b>	92	<b>113,00 €</b>
91C00300C1D	<b>GR M 3X0,35-6g</b>	91	<b>101,00 €</b>	92C00300C1D	<b>AR M 3X0,35-6g</b>	92	<b>101,00 €</b>
91C00350C1D	<b>GR M 3,5X0,35-6g</b>	91	<b>94,00 €</b>	92C00350C1D	<b>AR M 3,5X0,35-6g</b>	92	<b>94,00 €</b>
91C00400C1D	<b>GR M 4X0,35-6g</b>	91	<b>92,00 €</b>	92C00400C1D	<b>AR M 4X0,35-6g</b>	92	<b>92,00 €</b>
91C00450C1D	<b>GR M 4,5X0,35-6g</b>	91	<b>92,00 €</b>	92C00450C1D	<b>AR M 4,5X0,35-6g</b>	92	<b>92,00 €</b>
91C00500C1D	<b>GR M 5X0,35-6g</b>	91	<b>92,00 €</b>	92C00500C1D	<b>AR M 5X0,35-6g</b>	92	<b>92,00 €</b>
91C00600C1D	<b>GR M 6X0,35-6g</b>	91	<b>94,00 €</b>	92C00600C1D	<b>AR M 6X0,35-6g</b>	92	<b>94,00 €</b>
91C00700C1D	<b>GR M 7X0,35-6g</b>	91	<b>95,00 €</b>	92C00700C1D	<b>AR M 7X0,35-6g</b>	92	<b>95,00 €</b>
91C00800C1D	<b>GR M 8X0,35-6g</b>	91	<b>98,00 €</b>	92C00800C1D	<b>AR M 8X0,35-6g</b>	92	<b>98,00 €</b>
91C00900C1D	<b>GR M 9X0,35-6g</b>	91	<b>101,00 €</b>	92C00900C1D	<b>AR M 9X0,35-6g</b>	92	<b>101,00 €</b>
91C01000C1D	<b>GR M 10X0,35-6g</b>	91	<b>108,00 €</b>	92C01000C1D	<b>AR M 10X0,35-6g</b>	92	<b>108,00 €</b>

<b>Metrisches Feingewinde DIN ISO 13 - Steigung 0.5</b>							
91C00350F1D	<b>GR M 3,5X0,5-6g</b>	91	<b>82,00 €</b>	92C00350F1D	<b>AR M 3,5X0,5-6g</b>	92	<b>82,00 €</b>
91C00400F1D	<b>GR M 4X0,5-6g</b>	91	<b>81,00 €</b>	92C00400F1D	<b>AR M 4X0,5-6g</b>	92	<b>81,00 €</b>
91C00450F1D	<b>GR M 4,5X0,5-6g</b>	91	<b>81,00 €</b>	92C00450F1D	<b>AR M 4,5X0,5-6g</b>	92	<b>81,00 €</b>
91C00500F1D	<b>GR M 5X0,5-6g</b>	91	<b>81,00 €</b>	92C00500F1D	<b>AR M 5X0,5-6g</b>	92	<b>81,00 €</b>
91C00600F1D	<b>GR M 6X0,5-6g</b>	91	<b>82,00 €</b>	92C00600F1D	<b>AR M 6X0,5-6g</b>	92	<b>82,00 €</b>
91C00700F1D	<b>GR M 7X0,5-6g</b>	91	<b>84,00 €</b>	92C00700F1D	<b>AR M 7X0,5-6g</b>	92	<b>84,00 €</b>
91C00800F1D	<b>GR M 8X0,5-6g</b>	91L	<b>80,00 €</b>	92C00800F1D	<b>AR M 8X0,5-6g</b>	92L	<b>80,00 €</b>
91C00900F1D	<b>GR M 9X0,5-6g</b>	91	<b>88,00 €</b>	92C00900F1D	<b>AR M 9X0,5-6g</b>	92	<b>88,00 €</b>
91C01000F1D	<b>GR M 10X0,5-6g</b>	91L	<b>88,00 €</b>	92C01000F1D	<b>AR M 10X0,5-6g</b>	92L	<b>88,00 €</b>
91C01100F1D	<b>GR M 11X0,5-6g</b>	91	<b>102,00 €</b>	92C01100F1D	<b>AR M 11X0,5-6g</b>	92	<b>102,00 €</b>
91C01200F1D	<b>GR M 12X0,5-6g</b>	91	<b>108,00 €</b>	92C01200F1D	<b>AR M 12X0,5-6g</b>	92	<b>108,00 €</b>
91C01300F1D	<b>GR M 13X0,5-6g</b>	91	<b>112,00 €</b>	92C01300F1D	<b>AR M 13X0,5-6g</b>	92	<b>112,00 €</b>
0514040053	<b>GR M 14X0,5-6g</b>	153	<b>98,00 €</b>	0514050053	<b>AR M 14X0,5-6g</b>	153	<b>98,00 €</b>
0515040053	<b>GR M 15X0,5-6g</b>	153	<b>102,00 €</b>	0515050053	<b>AR M 15X0,5-6g</b>	153	<b>102,00 €</b>
0516040053	<b>GR M 16X0,5-6g</b>	153	<b>106,00 €</b>	0516050053	<b>AR M 16X0,5-6g</b>	153	<b>106,00 €</b>
0517040053	<b>GR M 17X0,5-6g</b>	153	<b>112,00 €</b>	0517050053	<b>AR M 17x0,5-6g</b>	153	<b>112,00 €</b>
0518040053	<b>GR M 18X0,5-6g</b>	153	<b>117,00 €</b>	0518050053	<b>AR M 18X0,5-6g</b>	153	<b>117,00 €</b>



ANr.	Beschreibung	AGr.	Einzelpreis	ANr.	Beschreibung	AGr.	Einzelpreis
<b>Metrisches Feingewinde DIN ISO 13 - Steigung 0.5</b>							
0519040053	<b>GR M 19X0,5-6g</b>	153	<b>122,00 €</b>	0519050053	<b>AR M 19x0,5-6g</b>	153	<b>122,00 €</b>
0520040053	<b>GR M 20X0,5-6g</b>	153	<b>128,00 €</b>	0520050053	<b>AR M 20X0,5-6g</b>	153	<b>128,00 €</b>
<b>Metrisches Feingewinde DIN ISO 13 - Steigung 0.75</b>							
91C0050011D	<b>GR M 5X0,75-6g</b>	91	<b>69,00 €</b>	92C0050011D	<b>AR M 5X0,75-6g</b>	92	<b>69,00 €</b>
91C0060011D	<b>GR M 6X0,75-6g</b>	91	<b>69,00 €</b>	92C0060011D	<b>AR M 6X0,75-6g</b>	92	<b>69,00 €</b>
91C0070011D	<b>GR M 7X0,75-6g</b>	91	<b>69,00 €</b>	92C0070011D	<b>AR M 7X0,75-6g</b>	92	<b>69,00 €</b>
91C0080011D	<b>GR M 8X0,75-6g</b>	91L	<b>59,00 €</b>	92C0080011D	<b>AR M 8X0,75-6g</b>	92L	<b>59,00 €</b>
91C0090011D	<b>GR M 9X0,75-6g</b>	91	<b>74,00 €</b>	92C0090011D	<b>AR M 9X0,75-6g</b>	92	<b>74,00 €</b>
91C0100011D	<b>GR M 10X0,75-6g</b>	91L	<b>64,00 €</b>	92C0100011D	<b>AR M 10X0,75-6g</b>	92L	<b>64,00 €</b>
91C0110011D	<b>GR M 11X0,75-6g</b>	91	<b>85,00 €</b>	92C0110011D	<b>AR M 11X0,75-6g</b>	92	<b>85,00 €</b>
91C0120011D	<b>GR M 12X0,75-6g</b>	91L	<b>72,00 €</b>	92C0120011D	<b>AR M 12X0,75-6g</b>	92L	<b>72,00 €</b>
91C0130011D	<b>GR M 13X0,75-6g</b>	91	<b>93,00 €</b>	92C0130011D	<b>AR M 13X0,75-6g</b>	92	<b>93,00 €</b>
0714040053	<b>GR M 14X0,75-6g</b>	153	<b>72,00 €</b>	0714050053	<b>AR M 14X0,75-6g</b>	153	<b>72,00 €</b>
0715040053	<b>GR M 15X0,75-6g</b>	153	<b>75,00 €</b>	0715050053	<b>AR M 15X0,75-6g</b>	153	<b>75,00 €</b>
0716040053	<b>GR M 16X0,75-6g</b>	153	<b>79,00 €</b>	0716050053	<b>AR M 16X0,75-6g</b>	153	<b>79,00 €</b>
0717040053	<b>GR M 17X0,75-6g</b>	153	<b>82,00 €</b>	0717050053	<b>AR M 17X0,75-6g</b>	153	<b>82,00 €</b>
0718040053	<b>GR M 18X0,75-6g</b>	153	<b>86,00 €</b>	0718050053	<b>AR M 18X0,75-6g</b>	153	<b>86,00 €</b>
0719040053	<b>GR M 19X0,75-6g</b>	153	<b>88,00 €</b>	0719050053	<b>AR M 19X0,75-6g</b>	153	<b>88,00 €</b>
0720040053	<b>GR M 20X0,75-6g</b>	153	<b>91,00 €</b>	0720050053	<b>AR M 20X0,75-6g</b>	153	<b>91,00 €</b>
0721040053	<b>GR M 21X0,75-6g</b>	153	<b>95,00 €</b>	0721050053	<b>AR M 21X0,75-6g</b>	153	<b>95,00 €</b>
0722040053	<b>GR M 22X0,75-6g</b>	153	<b>100,00 €</b>	0722050053	<b>AR M 22X0,75-6g</b>	153	<b>100,00 €</b>
0723040053	<b>GR M 23X0,75-6g</b>	153	<b>104,00 €</b>	0723050053	<b>AR M 23X0,75-6g</b>	153	<b>104,00 €</b>
0724040053	<b>GR M 24X0,75-6g</b>	153	<b>107,00 €</b>	0724050053	<b>AR M 24X0,75-6g</b>	153	<b>107,00 €</b>
0725040053	<b>GR M 25X0,75-6g</b>	153	<b>111,00 €</b>	0725050053	<b>AR M 25X0,75-6g</b>	153	<b>111,00 €</b>
0726040053	<b>GR M 26X0,75-6g</b>	153	<b>115,00 €</b>	0726050053	<b>AR M 26X0,75-6g</b>	153	<b>115,00 €</b>
0727040053	<b>GR M 27X0,75-6g</b>	153	<b>119,00 €</b>	0727050053	<b>AR M 27X0,75-6g</b>	153	<b>119,00 €</b>
0728040053	<b>GR M 28X0,75-6g</b>	153	<b>123,00 €</b>	0728050053	<b>AR M 28X0,75-6g</b>	153	<b>123,00 €</b>
0730040053	<b>GR M 30X0,75-6g</b>	153	<b>130,00 €</b>	0730050053	<b>AR M 30X0,75-6g</b>	153	<b>130,00 €</b>
<b>Metrisches Feingewinde DIN ISO 13 - Steigung 1</b>							
91C00800K1D	<b>GR M 8X1-6g</b>	91L	<b>54,00 €</b>	92C00800K1D	<b>AR M 8X1-6g</b>	92L	<b>54,00 €</b>
91C00900K1D	<b>GR M 9X1-6g</b>	91	<b>69,00 €</b>	92C00900K1D	<b>AR M 9X1-6g</b>	92	<b>69,00 €</b>
91C01000K1D	<b>GR M 10X1-6g</b>	91L	<b>61,00 €</b>	92C01000K1D	<b>AR M 10X1-6g</b>	92L	<b>61,00 €</b>
91C01100K1D	<b>GR M 11X1-6g</b>	91L	<b>63,00 €</b>	92C01100K1D	<b>AR M 11X1-6g</b>	92L	<b>63,00 €</b>
91C01200K1D	<b>GR M 12X1-6g</b>	91L	<b>69,00 €</b>	92C01200K1D	<b>AR M 12X1-6g</b>	92L	<b>69,00 €</b>
91C01300K1D	<b>GR M 13X1-6g</b>	91	<b>89,00 €</b>	92C01300K1D	<b>AR M 13X1-6g</b>	92	<b>89,00 €</b>
1014040053	<b>GR M 14X1-6g</b>	153L	<b>67,00 €</b>	1014050053	<b>AR M 14X1-6g</b>	153L	<b>67,00 €</b>
1015040053	<b>GR M 15X1-6g</b>	153	<b>72,00 €</b>	1015050053	<b>AR M 15X1-6g</b>	153	<b>72,00 €</b>
1016040053	<b>GR M 16X1-6g</b>	153L	<b>73,00 €</b>	1016050053	<b>AR M 16X1-6g</b>	153L	<b>73,00 €</b>
1017040053	<b>GR M 17X1-6g</b>	153	<b>77,00 €</b>	1017050053	<b>AR M 17X1-6g</b>	153	<b>77,00 €</b>
1018040053	<b>GR M 18X1-6g</b>	153L	<b>79,00 €</b>	1018050053	<b>AR M 18X1-6g</b>	153L	<b>79,00 €</b>

ANr.	Beschreibung	AGr.	Einzelpreis	ANr.	Beschreibung	AGr.	Einzelpreis
<b>Metrisches Feingewinde DIN ISO 13 - Steigung 1</b>							
1019040053	GR M 19X1-6g	153	83,00 €	1019050053	AR M 19X1-6g	153	83,00 €
1020040053	GR M 20X1-6g	153L	84,00 €	1020050053	AR M 20X1-6g	153L	84,00 €
1021040053	GR M 21X1-6g	153	89,00 €	1021050053	AR M 21X1-6g	153	89,00 €
1022040053	GR M 22X1-6g	153	94,00 €	1022050053	AR M 22X1-6g	153	94,00 €
1023040053	GR M 23X1-6g	153	98,00 €	1023050053	AR M 23X1-6g	153	98,00 €
1024040053	GR M 24X1-6g	153L	100,00 €	1024050053	AR M 24X1-6g	153L	100,00 €
1025040053	GR M 25X1-6g	153	105,00 €	1025050053	AR M 25X1-6g	153	105,00 €
1026040053	GR M 26X1-6g	153	107,00 €	1026050053	AR M 26X1-6g	153	107,00 €
1027040053	GR M 27X1-6g	153	110,00 €	1027050053	AR M 27X1-6g	153	110,00 €
1028040053	GR M 28X1-6g	153	112,00 €	1028050053	AR M 28X1-6g	153	112,00 €
1030040053	GR M 30X1-6g	153L	120,00 €	1030050053	AR M 30X1-6g	153L	120,00 €
1032040053	GR M 32X1-6g	153	125,00 €	1032050053	AR M 32X1-6g	153	125,00 €
1033040053	GR M 33X1-6g	153	129,00 €	1033050053	AR M 33X1-6g	153	129,00 €
1034040053	GR M 34X1-6g	153	134,00 €	1034050053	AR M 34X1-6g	153	134,00 €
1035040053	GR M 35X1-6g	153	136,00 €	1035050053	AR M 35X1-6g	153	136,00 €
1036040053	GR M 36X1-6g	153	139,00 €	1036050053	AR M 36X1-6g	153	139,00 €
1038040053	GR M 38X1-6g	153	147,00 €	1038050053	AR M 38X1-6g	153	147,00 €
1039040053	GR M 39X1-6g	153	153,00 €	1039050053	AR M 39X1-6g	153	153,00 €
1040040053	GR M 40X1-6g	153	155,00 €	1040050053	AR M 40X1-6g	153	155,00 €
1042040053	GR M 42X1-6g	153	163,00 €	1042050053	AR M 42X1-6g	153	163,00 €
1045040053	GR M 45X1-6g	153	174,00 €	1045050053	AR M 45X1-6g	153	174,00 €
1048040053	GR M 48X1-6g	153	184,00 €	1048050053	AR M 48X1-6g	153	184,00 €
1050040053	GR M 50X1-6g	153	190,00 €	1050050053	AR M 50X1-6g	153	190,00 €
1052040053	GR M 52X1-6g	153	199,00 €	1052050053	AR M 52X1-6g	153	199,00 €
1055040053	GR M 55X1-6g	153	209,00 €	1055050053	AR M 55X1-6g	153	209,00 €
1056040053	GR M 56X1-6g	153	212,00 €	1056050053	AR M 56X1-6g	153	212,00 €
1058040053	GR M 58X1-6g	153	220,00 €	1058050053	AR M 58X1-6g	153	220,00 €
1060040053	GR M 60X1-6g	153	227,00 €	1060050053	AR M 60X1-6g	153	227,00 €
1062040053	GR M 62X1-6g	153	234,00 €	1062050053	AR M 62X1-6g	153	234,00 €
1064040053	GR M 64X1-6g	153	240,00 €	1064050053	AR M 64X1-6g	153	240,00 €
1065040053	GR M 65X1-6g	153	244,00 €	1065050053	AR M 65X1-6g	153	244,00 €
1068040053	GR M 68X1-6g	153	254,00 €	1068050053	AR M 68X1-6g	153	254,00 €
1070040053	GR M 70X1-6g	153	260,00 €	1070050053	AR M 70X1-6g	153	260,00 €
1072040053	GR M 72X1-6g	153	267,00 €	1072050053	AR M 72X1-6g	153	267,00 €
1075040053	GR M 75X1-6g	153	284,00 €	1075050053	AR M 75X1-6g	153	284,00 €
1076040053	GR M 76X1-6g	153	289,00 €	1076050053	AR M 76X1-6g	153	289,00 €
1078040053	GR M 78X1-6g	153	300,00 €	1078050053	AR M 78X1-6g	153	300,00 €
1080040053	GR M 80X1-6g	153	309,00 €	1080050053	AR M 80X1-6g	153	309,00 €
<b>Metrisches Feingewinde DIN ISO 13 - Steigung 1,25</b>							
91C01000L1D	GR M 10X1,25-6g	91L	70,00 €	92C01000L1D	AR M 10X1,25-6g	92L	70,00 €
91C01200L1D	GR M 12X1,25-6g	91L	79,00 €	92C01200L1D	AR M 12X1,25-6g	92L	79,00 €
1214040053	GR M 14X1,25-6g	153L	63,00 €	1214050053	AR M 14X1,25-6g	153L	63,00 €

ANr.	Beschreibung	AGr.	Einzelpreis	ANr.	Beschreibung	AGr.	Einzelpreis
<b>Metrisches Feingewinde DIN ISO 13 - Steigung 1,5</b>							
91C01200M1D	<b>GR M 12X1,5-6g</b>	91L	<b>68,00 €</b>	92C01200M1D	<b>AR M 12X1,5-6g</b>	92L	<b>68,00 €</b>
91C01300M1D	<b>GR M 13X1,5-6g</b>	91	<b>87,00 €</b>	92C01300M1D	<b>AR M 13X1,5-6g</b>	92	<b>87,00 €</b>
1514040053	<b>GR M 14X1,5-6g</b>	153L	<b>63,00 €</b>	1514050053	<b>AR M 14X1,5-6g</b>	153L	<b>63,00 €</b>
1515040053	<b>GR M 15X1,5-6g</b>	153	<b>68,00 €</b>	1515050053	<b>AR M 15X1,5-6g</b>	153	<b>68,00 €</b>
1516040053	<b>GR M 16X1,5-6g</b>	153L	<b>65,00 €</b>	1516050053	<b>AR M 16X1,5-6g</b>	153L	<b>65,00 €</b>
1517040053	<b>GR M 17X1,5-6g</b>	153	<b>74,00 €</b>	1517050053	<b>AR M 17X1,5-6g</b>	153	<b>74,00 €</b>
1518040053	<b>GR M 18X1,5-6g</b>	153L	<b>73,00 €</b>	1518050053	<b>AR M 18X1,5-6g</b>	153L	<b>73,00 €</b>
1519040053	<b>GR M 19X1,5-6g</b>	153	<b>79,00 €</b>	1519050053	<b>AR M 19X1,5-6g</b>	153	<b>79,00 €</b>
1520040053	<b>GR M 20X1,5-6g</b>	153L	<b>79,00 €</b>	1520050053	<b>AR M 20X1,5-6g</b>	153L	<b>79,00 €</b>
1521040053	<b>GR M 21X1,5-6g</b>	153	<b>85,00 €</b>	1521050053	<b>AR M 21X1,5-6g</b>	153	<b>85,00 €</b>
1522040053	<b>GR M 22X1,5-6g</b>	153L	<b>85,00 €</b>	1522050053	<b>AR M 22X1,5-6g</b>	153L	<b>85,00 €</b>
1523040053	<b>GR M 23X1,5-6g</b>	153	<b>91,00 €</b>	1523050053	<b>AR M 23x1,5-6g</b>	153	<b>91,00 €</b>
1524040053	<b>GR M 24X1,5-6g</b>	153L	<b>91,00 €</b>	1524050053	<b>AR M 24X1,5-6g</b>	153L	<b>91,00 €</b>
1525040053	<b>GR M 25X1,5-6g</b>	153L	<b>93,00 €</b>	1525050053	<b>AR M 25X1,5-6g</b>	153L	<b>93,00 €</b>
1526040053	<b>GR M 26X1,5-6g</b>	153L	<b>97,00 €</b>	1526050053	<b>AR M 26X1,5-6g</b>	153L	<b>97,00 €</b>
1527040053	<b>GR M 27X1,5-6g</b>	153L	<b>100,00 €</b>	1527050053	<b>AR M 27X1,5-6g</b>	153L	<b>100,00 €</b>
1528040053	<b>GR M 28X1,5-6g</b>	153L	<b>103,00 €</b>	1528050053	<b>AR M 28X1,5-6g</b>	153L	<b>103,00 €</b>
1530040053	<b>GR M 30X1,5-6g</b>	153L	<b>109,00 €</b>	1530050053	<b>AR M 30X1,5-6g</b>	153L	<b>109,00 €</b>
1532040053	<b>GR M 32X1,5-6g</b>	153L	<b>113,00 €</b>	1532050053	<b>AR M 32X1,5-6g</b>	153L	<b>113,00 €</b>
1533040053	<b>GR M 33X1,5-6g</b>	153L	<b>118,00 €</b>	1533050053	<b>AR M 33X1,5-6g</b>	153L	<b>118,00 €</b>
1534040053	<b>GR M 34X1,5-6g</b>	153	<b>123,00 €</b>	1534050053	<b>AR M 34X1,5-6g</b>	153	<b>123,00 €</b>
1535040053	<b>GR M 35x1,5-6g</b>	153L	<b>123,00 €</b>	1535050053	<b>AR M 35X1,5-6g</b>	153L	<b>123,00 €</b>
1536040053	<b>GR M 36X1,5-6g</b>	153L	<b>126,00 €</b>	1536050053	<b>AR M 36X1,5-6g</b>	153L	<b>126,00 €</b>
1538040053	<b>GR M 38X1,5-6g</b>	153L	<b>133,00 €</b>	1538050053	<b>AR M 38X1,5-6g</b>	153L	<b>133,00 €</b>
1539040053	<b>GR M 39X1,5-6g</b>	153	<b>140,00 €</b>	1539050053	<b>AR M 39X1,5-6g</b>	153	<b>140,00 €</b>
1540040053	<b>GR M 40X1,5-6g</b>	153L	<b>140,00 €</b>	1540050053	<b>AR M 40X1,5-6g</b>	153L	<b>140,00 €</b>
1542040053	<b>GR M 42X1,5-6g</b>	153L	<b>144,00 €</b>	1542050053	<b>AR M 42X1,5-6g</b>	153L	<b>144,00 €</b>
1545040053	<b>GR M 45X1,5-6g</b>	153L	<b>148,00 €</b>	1545050053	<b>AR M 45X1,5-6g</b>	153L	<b>148,00 €</b>
1548040053	<b>GR M 48X1,5-6g</b>	153L	<b>152,00 €</b>	1548050053	<b>AR M 48X1,5-6g</b>	153L	<b>152,00 €</b>
1550040053	<b>GR M 50X1,5-6g</b>	153L	<b>157,00 €</b>	1550050053	<b>AR M 50X1,5-6g</b>	153L	<b>157,00 €</b>
1552040053	<b>GR M 52X1,5-6g</b>	153L	<b>164,00 €</b>	1552050053	<b>AR M 52X1,5-6g</b>	153L	<b>164,00 €</b>
1555040053	<b>GR M 55X1,5-6g</b>	153L	<b>170,00 €</b>	1555050053	<b>AR M 55X1,5-6g</b>	153L	<b>170,00 €</b>
1556040053	<b>GR M 56X1,5-6g</b>	153L	<b>174,00 €</b>	1556050053	<b>AR M 56X1,5-6g</b>	153L	<b>174,00 €</b>
1558040053	<b>GR M 58X1,5-6g</b>	153L	<b>177,00 €</b>	1558050053	<b>AR M 58X1,5-6g</b>	153L	<b>177,00 €</b>
1560040053	<b>GR M 60X1,5-6g</b>	153	<b>184,00 €</b>	1560050053	<b>AR M 60X1,5-6g</b>	153	<b>184,00 €</b>
1562040053	<b>GR M 62X1,5-6g</b>	153L	<b>191,00 €</b>	1562050053	<b>AR M 62X1,5-6g</b>	153L	<b>191,00 €</b>
1564040053	<b>GR M 64X1,5-6g</b>	153	<b>197,00 €</b>	1564050053	<b>AR M 64X1,5-6g</b>	153	<b>197,00 €</b>
1565040053	<b>GR M 65X1,5-6g</b>	153L	<b>200,00 €</b>	1565050053	<b>AR M 65X1,5-6g</b>	153L	<b>200,00 €</b>
1568040053	<b>GR M 68X1,5-6g</b>	153	<b>209,00 €</b>	1568050053	<b>AR M 68X1,5-6g</b>	153	<b>209,00 €</b>
1570040053	<b>GR M 70X1,5-6g</b>	153	<b>217,00 €</b>	1570050053	<b>AR M 70X1,5-6g</b>	153	<b>217,00 €</b>
1572040053	<b>GR M 72X1,5-6g</b>	153	<b>225,00 €</b>	1572050053	<b>AR M 72X1,5-6g</b>	153	<b>225,00 €</b>
1575040053	<b>GR M 75X1,5-6g</b>	153	<b>233,00 €</b>	1575050053	<b>AR M 75X1,5-6g</b>	153	<b>233,00 €</b>
1576040053	<b>GR M 76X1,5-6g</b>	153	<b>242,00 €</b>	1576050053	<b>AR M 76X1,5-6g</b>	153	<b>242,00 €</b>
1578040053	<b>GR M 78X1,5-6g</b>	153	<b>264,00 €</b>	1578050053	<b>AR M 78X1,5-6g</b>	153	<b>264,00 €</b>

ANr.	Beschreibung	AGr.	Einzelpreis	ANr.	Beschreibung	AGr.	Einzelpreis
<b>Metrisches Feingewinde DIN ISO 13 - Steigung 1,5</b>							
1580040053	GR M 80X1,5-6g	153	271,00 €	1580050053	AR M 80X1,5-6g	153	271,00 €
1582040053	GR M 82X1,5-6g	153	280,00 €	1582050053	AR M 82X1,5-6g	153	280,00 €
1585040053	GR M 85X1,5-6g	153	288,00 €	1585050053	AR M 85X1,5-6g	153	288,00 €
1588040053	GR M 88X1,5-6g	153	305,00 €	1588050053	AR M 88X1,5-6g	153	305,00 €
1590040053	GR M 90X1,5-6g	153	305,00 €	1590050053	AR M 90X1,5-6g	153	305,00 €
1592040053	GR M 92X1,5-6g	153	322,00 €	1592050053	AR M 92X1,5-6g	153	322,00 €
1595040053	GR M 95X1,5-6g	153	322,00 €	1595050053	AR M 95X1,5-6g	153	322,00 €
1598040053	GR M 98X1,5-6g	153	338,00 €	1598050053	AR M 98X1,5-6g	153	338,00 €
1595240053	GR M100X1,5-6g	153	338,00 €	1595250053	AR M100X1,5-6g	153	338,00 €
1595440053	GR M105X1,5-6g	153	356,00 €	1595450053	AR M105X1,5-6g	153	356,00 €
1595640053	GR M110X1,5-6g	153	374,00 €	1595650053	AR M110X1,5-6g	153	374,00 €
1595840053	GR M115X1,5-6g	153	391,00 €	1595850053	AR M115X1,5-6g	153	391,00 €
1596040053	GR M120X1,5-6g	153	409,00 €	1596050053	AR M120X1,5-6g	153	409,00 €
1596240053	GR M125X1,5-6g	153	487,00 €	1596250053	AR M125X1,5-6g	153	487,00 €
1596440053	GR M130X1,5-6g	153	516,00 €	1596450053	AR M130X1,5-6g	153	516,00 €
1596640053	GR M135X1,5-6g	153	546,00 €	1596650053	AR M135X1,5-6g	153	546,00 €
1596840053	GR M140X1,5-6g	153	574,00 €	1596850053	AR M140X1,5-6g	153	574,00 €
1597040053	GR M145X1,5-6g	153	600,00 €	1597050053	AR M145X1,5-6g	153	600,00 €
1597240053	GR M150X1,5-6g	153	629,00 €	1597250053	AR M150X1,5-6g	153	629,00 €
1597440053	GR M155X1,5-6g	153	657,00 €	1597450053	AR M155X1,5-6g	153	657,00 €
1597640053	GR M160X1,5-6g	153	693,00 €	1597650053	AR M160X1,5-6g	153	693,00 €
1598040053	GR M170X1,5-6g	153	743,00 €	1598050053	AR M170X1,5-6g	153	743,00 €
1598240053	GR M175X1,5-6g	153	771,00 €	1598250053	AR M175X1,5-6g	153	771,00 €
1598440053	GR M180X1,5-6g	153	799,00 €	1598450053	AR M180X1,5-6g	153	799,00 €
1598640053	GR M185X1,5-6g	153	828,00 €	1598650053	AR M185X1,5-6g	153	828,00 €
1598840053	GR M190X1,5-6g	153	859,00 €	1598850053	AR M190X1,5-6g	153	859,00 €
1599040053	GR M195X1,5-6g	153	889,00 €	1599050053	AR M195X1,5-6g	153	889,00 €
1599240053	GR M200X1,5-6g	153	917,00 €	1599250053	AR M200X1,5-6g	153	917,00 €

<b>Metrisches Feingewinde DIN ISO 13 - Steigung 2</b>							
2018040053	GR M 18X2-6g	153	80,00 €	2018050053	AR M 18X2-6g	153	80,00 €
2019040053	GR M 19X2-6g	153	85,00 €	2019050053	AR M 19X2-6g	153	85,00 €
2020040053	GR M 20X2-6g	153L	83,00 €	2020050053	AR M 20X2-6g	153L	83,00 €
2021040053	GR M 21X2-6g	153	91,00 €	2021050053	AR M 21X2-6g	153	91,00 €
2022040053	GR M 22X2-6g	153	89,00 €	2022050053	AR M 22X2-6g	153	89,00 €
2023040053	GR M 23x2-6g	153	96,00 €	2023050053	AR M 23x2-6g	153	96,00 €
2024040053	GR M 24X2-6g	153L	96,00 €	2024050053	AR M 24X2-6g	153L	96,00 €
2025040053	GR M 25X2-6g	153	98,00 €	2025050053	AR M 25X2-6g	153	98,00 €
2026040053	GR M 26x2-6g	153	101,00 €	2026050053	AR M 26x2-6g	153	101,00 €
2027040053	GR M 27X2-6g	153L	105,00 €	2027050053	AR M 27X2-6g	153L	105,00 €
2028040053	GR M 28X2-6g	153	106,00 €	2028050053	AR M 28X2-6g	153	106,00 €
2030040053	GR M 30X2-6g	153L	113,00 €	2030050053	AR M 30X2-6g	153L	113,00 €
2032040053	GR M 32X2-6g	153	120,00 €	2032050053	AR M 32X2-6g	153	120,00 €

ANr.	Beschreibung	AGr.	Einzelpreis	ANr.	Beschreibung	AGr.	Einzelpreis
<b>Metrisches Feingewinde DIN ISO 13 - Steigung 2</b>							
2033040053	<b>GR M 33X2-6g</b>	153L	<b>114,00 €</b>	2033050053	<b>AR M 33X2-6g</b>	153L	<b>114,00 €</b>
2034040053	<b>GR M 34x2-6g</b>	153	<b>126,00 €</b>	2034050053	<b>AR M 34x2-6g</b>	153	<b>126,00 €</b>
2035040053	<b>GR M 35X2-6g</b>	153	<b>128,00 €</b>	2035050053	<b>AR M 35X2-6g</b>	153	<b>128,00 €</b>
2036040053	<b>GR M 36X2-6g</b>	153L	<b>131,00 €</b>	2036050053	<b>AR M 36X2-6g</b>	153L	<b>131,00 €</b>
2038040053	<b>GR M 38X2-6g</b>	153	<b>137,00 €</b>	2038050053	<b>AR M 38x2-6g</b>	153	<b>137,00 €</b>
2039040053	<b>GR M 39X2-6g</b>	153	<b>141,00 €</b>	2039050053	<b>AR M 39X2-6g</b>	153	<b>141,00 €</b>
2040040053	<b>GR M 40X2-6g</b>	153L	<b>145,00 €</b>	2040050053	<b>AR M 40X2-6g</b>	153L	<b>145,00 €</b>
2042040053	<b>GR M 42X2-6g</b>	153L	<b>152,00 €</b>	2042050053	<b>AR M 42X2-6g</b>	153L	<b>152,00 €</b>
2045040053	<b>GR M 45X2-6g</b>	153L	<b>157,00 €</b>	2045050053	<b>AR M 45X2-6g</b>	153L	<b>157,00 €</b>
2048040053	<b>GR M 48X2-6g</b>	153L	<b>166,00 €</b>	2048050053	<b>AR M 48X2-6g</b>	153L	<b>166,00 €</b>
2050040053	<b>GR M 50X2-6g</b>	153L	<b>169,00 €</b>	2050050053	<b>AR M 50X2-6g</b>	153L	<b>169,00 €</b>
2052040053	<b>GR M 52X2-6g</b>	153L	<b>177,00 €</b>	2052050053	<b>AR M 52X2-6g</b>	153L	<b>177,00 €</b>
2055040053	<b>GR M 55X2-6g</b>	153	<b>189,00 €</b>	2055050053	<b>AR M 55X2-6g</b>	153	<b>189,00 €</b>
2056040053	<b>GR M 56X2-6g</b>	153	<b>190,00 €</b>	2056050053	<b>AR M 56X2-6g</b>	153	<b>190,00 €</b>
2058040053	<b>GR M 58X2-6g</b>	153	<b>196,00 €</b>	2058050053	<b>AR M 58X2-6g</b>	153	<b>196,00 €</b>
2060040053	<b>GR M 60X2-6g</b>	153L	<b>201,00 €</b>	2060050053	<b>AR M 60X2-6g</b>	153L	<b>201,00 €</b>
2062040053	<b>GR M 62X2-6g</b>	153L	<b>210,00 €</b>	2062050053	<b>AR M 62X2-6g</b>	153L	<b>210,00 €</b>
2064040053	<b>GR M 64X2-6g</b>	153	<b>214,00 €</b>	2064050053	<b>AR M 64X2-6g</b>	153	<b>214,00 €</b>
2065040053	<b>GR M 65X2-6g</b>	153	<b>219,00 €</b>	2065050053	<b>AR M 65X2-6g</b>	153	<b>219,00 €</b>
2068040053	<b>GR M 68X2-6g</b>	153	<b>229,00 €</b>	2068050053	<b>AR M 68X2-6g</b>	153	<b>229,00 €</b>
2070040053	<b>GR M 70X2-6g</b>	153	<b>234,00 €</b>	2070050053	<b>AR M 70X2-6g</b>	153	<b>234,00 €</b>
2072040053	<b>GR M 72X2-6g</b>	153	<b>241,00 €</b>	2072050053	<b>AR M 72X2-6g</b>	153	<b>241,00 €</b>
2075040053	<b>GR M 75X2-6g</b>	153	<b>253,00 €</b>	2075050053	<b>AR M 75X2-6g</b>	153	<b>253,00 €</b>
2076040053	<b>GR M 76X2-6g</b>	153	<b>257,00 €</b>	2076050053	<b>AR M 76X2-6g</b>	153	<b>257,00 €</b>
2078040053	<b>GR M 78X2-6g</b>	153	<b>264,00 €</b>	2078050053	<b>AR M 78X2-6g</b>	153	<b>264,00 €</b>
2080040053	<b>GR M 80X2-6g</b>	153	<b>276,00 €</b>	2080050053	<b>AR M 80X2-6g</b>	153	<b>276,00 €</b>
2082040053	<b>GR M 82X2-6g</b>	153	<b>281,00 €</b>	2082050053	<b>AR M 82X2-6g</b>	153	<b>281,00 €</b>
2085040053	<b>GR M 85X2-6g</b>	153	<b>294,00 €</b>	2085050053	<b>AR M 85X2-6g</b>	153	<b>294,00 €</b>
2088040053	<b>GR M 88X2-6g</b>	153	<b>310,00 €</b>	2088050053	<b>AR M 88x2-6g</b>	153	<b>310,00 €</b>
2090040053	<b>GR M 90X2-6g</b>	153	<b>317,00 €</b>	2090050053	<b>AR M 90X2-6g</b>	153	<b>317,00 €</b>
2092040053	<b>GR M 92X2-6g</b>	153	<b>330,00 €</b>	2092050053	<b>AR M 92X2-6g</b>	153	<b>330,00 €</b>
2095040053	<b>GR M 95X2-6g</b>	153	<b>339,00 €</b>	2095050053	<b>AR M 95X2-6g</b>	153	<b>339,00 €</b>
2095140053	<b>GR M 98X2-6g</b>	153	<b>354,00 €</b>	2095150053	<b>AR M 98X2-6g</b>	153	<b>354,00 €</b>
2095240053	<b>GR M100X2-6g</b>	153	<b>360,00 €</b>	2095250053	<b>AR M100X2-6g</b>	153	<b>360,00 €</b>
2095440053	<b>GR M105X2-6g</b>	153	<b>381,00 €</b>	2095450053	<b>AR M105X2-6g</b>	153	<b>381,00 €</b>
2095640053	<b>GR M110X2-6g</b>	153	<b>401,00 €</b>	2095650053	<b>AR M110X2-6g</b>	153	<b>401,00 €</b>
2095840053	<b>GR M115X2-6g</b>	153	<b>430,00 €</b>	2095850053	<b>AR M115X2-6g</b>	153	<b>430,00 €</b>
2096040053	<b>GR M120X2-6g</b>	153	<b>457,00 €</b>	2096050053	<b>AR M120X2-6g</b>	153	<b>457,00 €</b>
2096240053	<b>GR M125X2-6g</b>	153	<b>491,00 €</b>	2096250053	<b>AR M125X2-6g</b>	153	<b>491,00 €</b>
2096440053	<b>GR M130X2-6g</b>	153	<b>520,00 €</b>	2096450053	<b>AR M130X2-6g</b>	153	<b>520,00 €</b>
2096640053	<b>GR M135X2-6g</b>	153	<b>549,00 €</b>	2096650053	<b>AR M135X2-6g</b>	153	<b>549,00 €</b>
2096840053	<b>GR M140X2-6g</b>	153	<b>577,00 €</b>	2096850053	<b>AR M140X2-6g</b>	153	<b>577,00 €</b>
2097040053	<b>GR M145X2-6g</b>	153	<b>606,00 €</b>	2097050053	<b>AR M145X2-6g</b>	153	<b>606,00 €</b>
2097240053	<b>GR M150X2-6g</b>	153	<b>634,00 €</b>	2097250053	<b>AR M150X2-6g</b>	153	<b>634,00 €</b>



ANr.	Beschreibung	AGr.	Einzelpreis	ANr.	Beschreibung	AGr.	Einzelpreis
<b>Metrisches Feingewinde DIN ISO 13 - Steigung 2</b>							
2097440053	GR M155X2-6g	153	663,00 €	2097450053	AR M155X2-6g	153	663,00 €
2097640053	GR M160X2-6g	153	691,00 €	2097650053	AR M160X2-6g	153	691,00 €
2097840053	GR M165X2-6g	153	717,00 €	2097850053	AR M165X2-6g	153	717,00 €
2098040053	GR M170X2-6g	153	746,00 €	2098050053	AR M170X2-6g	153	746,00 €
2098240053	GR M175X2-6g	153	771,00 €	2098250053	AR M175X2-6g	153	771,00 €
2098440053	GR M180X2-6g	153	803,00 €	2098450053	AR M180X2-6g	153	803,00 €
2098640053	GR M185X2-6g	153	829,00 €	2098650053	AR M185X2-6g	153	829,00 €
2098840053	GR M190X2-6g	153	860,00 €	2098850053	AR M190X2-6g	153	860,00 €
2099040053	GR M195X2-6g	153	889,00 €	2099050053	AR M195X2-6g	153	889,00 €
2099240053	GR M200X2-6g	153	917,00 €	2099250053	AR M200X2-6g	153	917,00 €

<b>Metrisches Feingewinde DIN ISO 13 - Steigung 3</b>							
3030040053	GR M 30X3-6g	153	121,00 €	3030050053	AR M 30X3-6g	153	121,00 €
3032040053	GR M 32X3-6g	153	125,00 €	3032050053	AR M 32X3-6g	153	125,00 €
3033040053	GR M 33X3-6g	153	129,00 €	3033050053	AR M 33X3-6g	153	129,00 €
3035040053	GR M 35X3-6g	153	139,00 €	3035050053	AR M 35X3-6g	153	139,00 €
3036040053	GR M 36X3-6g	153	139,00 €	3036050053	AR M 36X3-6g	153	139,00 €
3038040053	GR M 38X3-6g	153	152,00 €	3038050053	AR M 38X3-6g	153	152,00 €
3039040053	GR M 39X3-6g	153	152,00 €	3039050053	AR M 39X3-6g	153	152,00 €
3040040053	GR M 40X3-6g	153	155,00 €	3040050053	AR M 40X3-6g	153	155,00 €
3042040053	GR M 42X3-6g	153	160,00 €	3042050053	AR M 42X3-6g	153	160,00 €
3045040053	GR M 45X3-6g	153	164,00 €	3045050053	AR M 45X3-6g	153	164,00 €
3048040053	GR M 48X3-6g	153	168,00 €	3048050053	AR M 48X3-6g	153	168,00 €
3050040053	GR M 50X3-6g	153	173,00 €	3050050053	AR M 50X3-6g	153	173,00 €
3052040053	GR M 52X3-6g	153	188,00 €	3052050053	AR M 52X3-6g	153	188,00 €
3055040053	GR M 55X3-6g	153	199,00 €	3055050053	AR M 55X3-6g	153	199,00 €
3056040053	GR M 56X3-6g	153	202,00 €	3056050053	AR M 56X3-6g	153	202,00 €
3058040053	GR M 58X3-6g	153	209,00 €	3058050053	AR M 58X3-6g	153	209,00 €
3060040053	GR M 60X3-6g	153	215,00 €	3060050053	AR M 60X3-6g	153	215,00 €
3062040053	GR M 62X3-6g	153	224,00 €	3062050053	AR M 62X3-6g	153	224,00 €
3064040053	GR M 64X3-6g	153	230,00 €	3064050053	AR M 64X3-6g	153	230,00 €
3065040053	GR M 65X3-6g	153	233,00 €	3065050053	AR M 65X3-6g	153	233,00 €
3068040053	GR M 68X3-6g	153	240,00 €	3068050053	AR M 68X3-6g	153	240,00 €
3070040053	GR M 70X3-6g	153	249,00 €	3070050053	AR M 70X3-6g	153	249,00 €
3072040053	GR M 72X3-6g	153	258,00 €	3072050053	AR M 72X3-6g	153	258,00 €
3075040053	GR M 75X3-6g	153	267,00 €	3075050053	AR M 75X3-6g	153	267,00 €
3076040053	GR M 76X3-6g	153	267,00 €	3076050053	AR M 76X3-6g	153	267,00 €
3078040053	GR M 78X3-6g	153	289,00 €	3078050053	AR M 78x3-6g	153	289,00 €
3080040053	GR M 80X3-6g	153	299,00 €	3080050053	AR M 80X3-6g	153	299,00 €
3082040053	GR M 82X3-6g	153	335,00 €	3082050053	AR M 82X3-6g	153	335,00 €
3085040053	GR M 85X3-6g	153	331,00 €	3085050053	AR M 85X3-6g	153	331,00 €
3088040053	GR M 88X3-6g	153	366,00 €	3088050053	AR M 88X3-6g	153	366,00 €
3090040053	GR M 90X3-6g	153	354,00 €	3090050053	AR M 90X3-6g	153	354,00 €

ANr.	Beschreibung	AGr.	Einzelpreis	ANr.	Beschreibung	AGr.	Einzelpreis
<b>Metrisches Feingewinde DIN ISO 13 - Steigung 3</b>							
3092040053	GR M 92X3-6g	153	387,00 €	3092050053	AR M 92X3-6g	153	387,00 €
3095040053	GR M 95X3-6g	153	380,00 €	3095050053	AR M 95X3-6g	153	380,00 €
3095240053	GR M100X3-6g	153	403,00 €	3095250053	AR M100X3-6g	153	403,00 €
3095440053	GR M105X3-6g	153	426,00 €	3095450053	AR M105X3-6g	153	426,00 €
3095640053	GR M110X3-6g	153	449,00 €	3095650053	AR M110X3-6g	153	449,00 €
3095840053	GR M115X3-6g	153	469,00 €	3095850053	AR M115X3-6g	153	469,00 €
3096040053	GR M120X3-6g	153	491,00 €	3096050053	AR M120X3-6g	153	491,00 €
3096240053	GR M125X3-6g	153	540,00 €	3096250053	AR M125X3-6g	153	540,00 €
3096440053	GR M130X3-6g	153	566,00 €	3096450053	AR M130X3-6g	153	566,00 €
3096640053	GR M135X3-6g	153	603,00 €	3096650053	AR M135X3-6g	153	603,00 €
3096840053	GR M140X3-6g	153	631,00 €	3096850053	AR M140X3-6g	153	631,00 €
3097040053	GR M145X3-6g	153	674,00 €	3097050053	AR M145X3-6g	153	674,00 €
3097240053	GR M150X3-6g	153	694,00 €	3097250053	AR M150X3-6g	153	694,00 €
3097440053	GR M155X3-6g	153	729,00 €	3097450053	AR M155X3-6g	153	729,00 €
3097640053	GR M160X3-6g	153	757,00 €	3097650053	AR M160X3-6g	153	757,00 €
3097840053	GR M165X3-6g	153	786,00 €	3097850053	AR M165X3-6g	153	786,00 €
3098040053	GR M170X3-6g	153	820,00 €	3098050053	AR M170X3-6g	153	820,00 €
3098240053	GR M175X3-6g	153	851,00 €	3098250053	AR M175X3-6g	153	851,00 €
3098440053	GR M180X3-6g	153	883,00 €	3098450053	AR M180X3-6g	153	883,00 €
3098640053	GR M185X3-6g	153	911,00 €	3098650053	AR M185X3-6g	153	911,00 €
3098840053	GR M190X3-6g	153	943,00 €	3098850053	AR M190X3-6g	153	943,00 €
3099040053	GR M195X3-6g	153	974,00 €	3099050053	AR M195X3-6g	153	974,00 €
3099240053	GR M200X3-6g	153	1.006,00 €	3099250053	AR M200X3-6g	153	1.006,00 €

<b>Metrisches Feingewinde DIN ISO 13 - Steigung 4</b>							
4042040053	GR M 42X4-6g	153	163,00 €	4042050053	AR M 42X4-6g	153	163,00 €
4045040053	GR M 45X4-6g	153	171,00 €	4045050053	AR M 45X4-6g	153	171,00 €
4048040053	GR M 48X4-6g	153	183,00 €	4048050053	AR M 48X4-6g	153	183,00 €
4050040053	GR M 50X4-6g	153	249,00 €	4050050053	AR M 50X4-6g	153	249,00 €
4052040053	GR M 52X4-6g	153	197,00 €	4052050053	AR M 52X4-6g	153	197,00 €
4055040053	GR M 55X4-6g	153	207,00 €	4055050053	AR M 55X4-6g	153	207,00 €
4056040053	GR M 56X4-6g	153	211,00 €	4056050053	AR M 56X4-6g	153	211,00 €
4058040053	GR M 58X4-6g	153	220,00 €	4058050053	AR M 58X4-6g	153	220,00 €
4060040053	GR M 60X4-6g	153	227,00 €	4060050053	AR M 60X4-6g	153	227,00 €
4062040053	GR M 62X4-6g	153	233,00 €	4062050053	AR M 62X4-6g	153	233,00 €
4064040053	GR M 64X4-6g	153	240,00 €	4064050053	AR M 64X4-6g	153	240,00 €
4065040053	GR M 65X4-6g	153	243,00 €	4065050053	AR M 65X4-6g	153	243,00 €
4068040053	GR M 68X4-6g	153	254,00 €	4068050053	AR M 68X4-6g	153	254,00 €
4070040053	GR M 70X4-6g	153	260,00 €	4070050053	AR M 70X4-6g	153	260,00 €
4072040053	GR M 72X4-6g	153	267,00 €	4072050053	AR M 72X4-6g	153	267,00 €
4075040053	GR M 75X4-6g	153	284,00 €	4075050053	AR M 75X4-6g	153	284,00 €
4076040053	GR M 76X4-6g	153	289,00 €	4076050053	AR M 76X4-6g	153	289,00 €
4078040053	GR M 78X4-6g	153	402,00 €	4078050053	AR M 78X4-6g	153	402,00 €

ANr.	Beschreibung	AGr.	Einzelpreis	ANr.	Beschreibung	AGr.	Einzelpreis
<b>Metrisches Feingewinde DIN ISO 13 - Steigung 4</b>							
4080040053	<b>GR M 80X4-6g</b>	153	<b>309,00 €</b>	4080050053	<b>AR M 80X4-6g</b>	153	<b>309,00 €</b>
4082040053	<b>GR M 82X4-6g</b>	153	<b>426,00 €</b>	4082050053	<b>AR M 82X4-6g</b>	153	<b>426,00 €</b>
4085040053	<b>GR M 85X4-6g</b>	153	<b>331,00 €</b>	4085050053	<b>AR M 85X4-6g</b>	153	<b>331,00 €</b>
4088040053	<b>GR M 88X4-6g</b>	153	<b>463,00 €</b>	4088050053	<b>AR M 88X4-6g</b>	153	<b>463,00 €</b>
4090040053	<b>GR M 90X4-6g</b>	153	<b>356,00 €</b>	4090050053	<b>AR M 90X4-6g</b>	153	<b>356,00 €</b>
4092040053	<b>GR M 92X4-6g</b>	153	<b>489,00 €</b>	4092050053	<b>AR M 92X4-6g</b>	153	<b>489,00 €</b>
4095040053	<b>GR M 95X4-6g</b>	153	<b>380,00 €</b>	4095050053	<b>AR M 95X4-6g</b>	153	<b>380,00 €</b>
4098040053	<b>GR M 98X4-6g</b>	153	<b>513,00 €</b>	4098050053	<b>AR M 98X4-6g</b>	153	<b>513,00 €</b>
4095240053	<b>GR M100X4-6g</b>	153	<b>403,00 €</b>	4095250053	<b>AR M100X4-6g</b>	153	<b>403,00 €</b>
4095440053	<b>GR M105X4-6g</b>	153	<b>426,00 €</b>	4095450053	<b>AR M105X4-6g</b>	153	<b>426,00 €</b>
4095640053	<b>GR M110X4-6g</b>	153	<b>451,00 €</b>	4095650053	<b>AR M110X4-6g</b>	153	<b>451,00 €</b>
4095840053	<b>GR M115X4-6g</b>	153	<b>481,00 €</b>	4095850053	<b>AR M115X4-6g</b>	153	<b>481,00 €</b>
4096040053	<b>GR M120X4-6g</b>	153	<b>511,00 €</b>	4096050053	<b>AR M120X4-6g</b>	153	<b>511,00 €</b>
4096240053	<b>GR M125X4-6g</b>	153	<b>543,00 €</b>	4096250053	<b>AR M125X4-6g</b>	153	<b>543,00 €</b>
4096440053	<b>GR M130X4-6g</b>	153	<b>571,00 €</b>	4096450053	<b>AR M130X4-6g</b>	153	<b>571,00 €</b>
4096640053	<b>GR M135X4-6g</b>	153	<b>606,00 €</b>	4096650053	<b>AR M135X4-6g</b>	153	<b>606,00 €</b>
4096840053	<b>GR M140X4-6g</b>	153	<b>634,00 €</b>	4096850053	<b>AR M140X4-6g</b>	153	<b>634,00 €</b>
4097040053	<b>GR M145X4-6g</b>	153	<b>677,00 €</b>	4097050053	<b>AR M145X4-6g</b>	153	<b>677,00 €</b>
4097240053	<b>GR M150X4-6g</b>	153	<b>697,00 €</b>	4097250053	<b>AR M150X4-6g</b>	153	<b>697,00 €</b>
4097440053	<b>GR M155X4-6g</b>	153	<b>729,00 €</b>	4097450053	<b>AR M155X4-6g</b>	153	<b>729,00 €</b>
4097640053	<b>GR M160X4-6g</b>	153	<b>760,00 €</b>	4097650053	<b>AR M160X4-6g</b>	153	<b>760,00 €</b>
4097840053	<b>GR M165X4-6g</b>	153	<b>789,00 €</b>	4097850053	<b>AR M165X4-6g</b>	153	<b>789,00 €</b>
4098040053	<b>GR M170X4-6g</b>	153	<b>820,00 €</b>	4098050053	<b>AR M170X4-6g</b>	153	<b>820,00 €</b>
4098240053	<b>GR M175X4-6g</b>	153	<b>851,00 €</b>	4098250053	<b>AR M175X4-6g</b>	153	<b>851,00 €</b>
4098440053	<b>GR M180X4-6g</b>	153	<b>883,00 €</b>	4098450053	<b>AR M180X4-6g</b>	153	<b>883,00 €</b>
4098640053	<b>GR M185X4-6g</b>	153	<b>911,00 €</b>	4098650053	<b>AR M185X4-6g</b>	153	<b>911,00 €</b>
4098840053	<b>GR M190X4-6g</b>	153	<b>943,00 €</b>	4098850053	<b>AR M190X4-6g</b>	153	<b>943,00 €</b>
4099040053	<b>GR M195X4-6g</b>	153	<b>974,00 €</b>	4099050053	<b>AR M195X4-6g</b>	153	<b>974,00 €</b>
4099240053	<b>GR M200X4-6g</b>	153	<b>1.006,00 €</b>	4099250053	<b>AR M200X4-6g</b>	153	<b>1.006,00 €</b>

<b>Metrisches Feingewinde DIN ISO 13 - Steigung 6</b>							
6070040053	<b>GR M 70X6-6g</b>	153	<b>291,00 €</b>	6070050053	<b>AR M 70X6-6g</b>	153	<b>291,00 €</b>
6072040053	<b>GR M 72X6-6g</b>	153	<b>300,00 €</b>	6072050053	<b>AR M 72X6-6g</b>	153	<b>300,00 €</b>
6075040053	<b>GR M 75X6-6g</b>	153	<b>384,00 €</b>	6075050053	<b>AR M 75X6-6g</b>	153	<b>384,00 €</b>
6076040053	<b>GR M 76X6-6g</b>	153	<b>314,00 €</b>	6076050053	<b>AR M 76X6-6g</b>	153	<b>314,00 €</b>
6078040053	<b>GR M 78X6-6g</b>	153	<b>420,00 €</b>	6078050053	<b>AR M 78X6-6g</b>	153	<b>420,00 €</b>
6080040053	<b>GR M 80X6-6g</b>	153	<b>334,00 €</b>	6080050053	<b>AR M 80X6-6g</b>	153	<b>334,00 €</b>
6082040053	<b>GR M 82X6-6g</b>	153	<b>448,00 €</b>	6082050053	<b>AR M 82X6-6g</b>	153	<b>448,00 €</b>
6085040053	<b>GR M 85X6-6g</b>	153	<b>360,00 €</b>	6085050053	<b>AR M 85X6-6g</b>	153	<b>360,00 €</b>
6088040053	<b>GR M 88X6-6g</b>	153	<b>488,00 €</b>	6088050053	<b>AR M 88X6-6g</b>	153	<b>488,00 €</b>
6090040053	<b>GR M 90X6-6g</b>	153	<b>386,00 €</b>	6090050053	<b>AR M 90X6-6g</b>	153	<b>386,00 €</b>
6092040053	<b>GR M 92X6-6g</b>	153	<b>513,00 €</b>	6092050053	<b>AR M 92X6-6g</b>	153	<b>513,00 €</b>
6095040053	<b>GR M 95X6-6g</b>	153	<b>414,00 €</b>	6095050053	<b>AR M 95X6-6g</b>	153	<b>414,00 €</b>



ANr.	Beschreibung	AGr.	Einzelpreis	ANr.	Beschreibung	AGr.	Einzelpreis
<b>Metrisches Feingewinde DIN ISO 13 - Steigung 6</b>							
6098040053	GR M 98X6-6g	153	541,00 €	6098050053	AR M 98X6-6g	153	541,00 €
6095240053	GR M100X6-6g	153	443,00 €	6095250053	AR M100X6-6g	153	443,00 €
6095440053	GR M105X6-6g	153	471,00 €	6095450053	AR M105X6-6g	153	471,00 €
6095640053	GR M110X6-6g	153	503,00 €	6095650053	AR M110X6-6g	153	503,00 €
6095840053	GR M115X6-6g	153	531,00 €	6095850053	AR M115X6-6g	153	531,00 €
6096040053	GR M120X6-6g	153	557,00 €	6096050053	AR M120X6-6g	153	557,00 €
6096240053	GR M125X6-6g	153	591,00 €	6096250053	AR M125X6-6g	153	591,00 €
6096440053	GR M130X6-6g	153	629,00 €	6096450053	AR M130X6-6g	153	629,00 €
6096640053	GR M135X6-6g	153	660,00 €	6096650053	AR M135X6-6g	153	660,00 €
6096840053	GR M140X6-6g	153	694,00 €	6096850053	AR M140X6-6g	153	694,00 €
6097040053	GR M145X6-6g	153	729,00 €	6097050053	AR M145X6-6g	153	729,00 €
6097240053	GR M150X6-6g	153	760,00 €	6097250053	AR M150X6-6g	153	760,00 €
6097440053	GR M155X6-6g	153	797,00 €	6097450053	AR M155X6-6g	153	797,00 €
6097640053	GR M160X6-6g	153	829,00 €	6097650053	AR M160X6-6g	153	829,00 €
6097840053	GR M165X6-6g	153	860,00 €	6097850053	AR M165X6-6g	153	860,00 €
6098040053	GR M170X6-6g	153	897,00 €	6098050053	AR M170X6-6g	153	897,00 €
6098240053	GR M175X6-6g	153	931,00 €	6098250053	AR M175X6-6g	153	931,00 €
6098440053	GR M180X6-6g	153	966,00 €	6098450053	AR M180X6-6g	153	966,00 €
6098640053	GR M185X6-6g	153	1.000,00 €	6098650053	AR M185X6-6g	153	1.000,00 €
6098840053	GR M190X6-6g	153	1.031,00 €	6098850053	AR M190X6-6g	153	1.031,00 €
6099040053	GR M195X6-6g	153	1.066,00 €	6099050053	AR M195X6-6g	153	1.066,00 €
6099240053	GR M200X6-6g	153	1.103,00 €	6099250053	AR M200X6-6g	153	1.103,00 €
<b>Whitworth Rohrgewinde DIN ISO 228</b>							
91E1011E	GR G 1/8 A DIN 228	91L	62,00 €	92E1011E	AR G 1/8 A DIN 228	92L	62,00 €
91E1021E	GR G 1/4 A DIN 228	91L	74,00 €	92E1021E	AR G 1/4 A DIN 228	92L	74,00 €
7000340053	GR G 3/8 A DIN 228	153L	84,00 €	7000350053	AR G 3/8 A DIN 228	153L	84,00 €
7000440053	GR G 1/2 A DIN 228	153L	100,00 €	7000450053	AR G 1/2 A DIN 228	153L	100,00 €
7000540053	GR G 5/8 A DIN 228	153	108,00 €	7000550053	AR G 5/8 A DIN 228	153	108,00 €
7000640053	GR G 3/4 A DIN 228	153L	119,00 €	7000650053	AR G 3/4 A DIN 228	153L	119,00 €
7000740053	GR G 7/8 A DIN 228	153	132,00 €	7000750053	AR G 7/8 A DIN 228	153	132,00 €
7000840053	GR G 1 A DIN 228	153L	146,00 €	7000850053	AR G 1 A DIN 228	153L	146,00 €
7000940053	GR G 1 1/8 A DIN 228	153	165,00 €	7000950053	AR G 1 1/8 A DIN 228	153	165,00 €
7001040053	GR G 1 1/4 A DIN 228	153L	172,00 €	7001050053	AR G 1 1/4 A DIN 228	153L	172,00 €
7002440053	GR G 1 3/8 A DIN 228	153	195,00 €	7002450053	AR G 1 3/8 A DIN 228	153	195,00 €
7001140053	GR G 1 1/2 A DIN 228	153L	195,00 €	7001150053	AR G 1 1/2 A DIN 228	153L	195,00 €
7001240053	GR G 1 3/4 A DIN 228	153L	215,00 €	7001250053	AR G 1 3/4 A DIN 228	153L	215,00 €
7001340053	GR G 2 A DIN 228	153L	232,00 €	7001350053	AR G 2 A DIN 228	153L	232,00 €
7001440053	GR G 2 1/4 A DIN 228	153L	253,00 €	7001450053	AR G 2 1/4 A DIN 228	153L	253,00 €
7001540053	GR G 2 1/2 A DIN 228	153L	294,00 €	7001550053	AR G 2 1/2 A DIN 228	153L	294,00 €
7001640053	GR G 2 3/4 A DIN 228	153L	327,00 €	7001650053	AR G 2 3/4 A DIN 228	153L	327,00 €
7001740053	GR G 3 A DIN 228	153L	351,00 €	7001750053	AR G 3 A DIN 228	153L	351,00 €
7002540053	GR G 3 1/4 A DIN 228	153	440,00 €	7002550053	AR G 3 1/4 A DIN 228	153	440,00 €

ANr.	Beschreibung	AGr.	Einzelpreis	ANr.	Beschreibung	AGr.	Einzelpreis
<b>Whitworth Rohrgewinde DIN ISO 228</b>							
7001840053	GR G 3 1/2 A DIN 228	153L	446,00 €	7001850053	AR G 3 1/2 A DIN 228	153L	446,00 €
7002640053	GR G 3 3/4 A DIN 228	153	484,00 €	7002650053	AR G 3 3/4 A DIN 228	153	484,00 €
7001940053	GR G 4 A DIN 228	153	512,00 €	7001950053	AR G 4 A DIN 228	153	512,00 €
7002040053	GR G 4 1/2 A DIN 228	153	590,00 €	7002050053	AR G 4 1/2 A DIN 228	153	590,00 €
7002140053	GR G 5 A DIN 228	153	675,00 €	7002150053	AR G 5 A DIN 228	153	675,00 €
7002240053	GR G 5 1/2 A DIN 228	153	759,00 €	7002250053	AR G 5 1/2 A DIN 228	153	759,00 €
7002340053	GR G 6 A DIN 228	153	843,00 €	7002350053	AR G 6 A DIN 228	153	843,00 €

<b>UNC - Unified Zollgewinde ANSI B1.1 - Lehrenmaße Gewindedorne ANSI B1.2 - Gewinderinge BS 919</b>							
91M14011	GR UNC No. 1-64 BS 919 (0.073)	91	100,00 €	92M14011	AR UNC No. 1-64 BS 919 (0.073)	92	100,00 €
91M14111	GR UNC No. 2-56 BS 919 (0.0860)	91	94,00 €	92M14111	AR UNC No. 2-56 BS 919 (0.0860)	92	94,00 €
91M14211	GR UNC No. 3-48 BS 919 (0.0990)	91	90,00 €	92M14211	AR UNC No. 3-48 BS 919 (0.0990)	92	90,00 €
91M14311	GR UNC No. 4-40 BS 919 (0.1120)	91L	79,00 €	92M14311	AR UNC No. 4-40 BS 919 (0.1120)	92L	79,00 €
91M14411	GR UNC No. 5-40 BS 919 (0.1250)	91	74,00 €	92M14411	AR UNC No. 5-40 BS 919 (0.1250)	92	74,00 €
91M14511	GR UNC No. 6-32 BS 919 (0.1380)	91L	58,00 €	92M14511	AR UNC No. 6-32 BS 919 (0.1380)	92L	58,00 €
91M14611	GR UNC No. 8-32 BS 919 (0.1640)	91L	53,00 €	92M14611	AR UNC No. 8-32 BS 919 (0.1640)	92L	53,00 €
91M14711	GR UNC No.10-24 BS 919 (0.190)	91L	52,00 €	92M14711	AR UNC No.10-24 BS 919 (0.190)	92L	52,00 €
91M14811	GR UNC No.12-24 BS 919 (0.2160)	91L	51,00 €	92M14811	AR UNC No.12-24 BS 919 (0.2160)	92L	51,00 €
91M14911	GR UNC 1/4-20-2A BS 919	91L	51,00 €	92M14911	AR UNC 1/4-20-2A BS 919	92L	51,00 €
91M15011	GR UNC 5/16-18-2A BS 919	91L	54,00 €	92M15011	AR UNC 5/16-18-2A BS 919	92L	54,00 €
91M15111	GR UNC 3/8-16-2A BS 919	91L	58,00 €	92M15111	AR UNC 3/8-16-2A BS 919	92L	58,00 €
91M15211	GR UNC 7/16-14-2A BS 919	91	76,00 €	92M15211	AR UNC 7/16-14-2A BS 919	92	76,00 €
91M15311	GR UNC 1/2-13-2A BS 919	91L	70,00 €	92M15311	AR UNC 1/2-13-2A BS 919	92L	70,00 €
7301540053	GR UNC 9/16-12-2A BS 919	153	69,00 €	7301550053	AR UNC 9/16-12-2A BS 919	153	69,00 €
7301640053	GR UNC 5/8-11-2A BS 919	153L	76,00 €	7301650053	AR UNC 5/8-11-2A BS 919	153L	76,00 €
7301740053	GR UNC 3/4-10-2A BS 919	153	89,00 €	7301750053	AR UNC 3/4-10-2A BS 919	153	89,00 €
7301840053	GR UNC 7/8-9-2A BS 919	153	100,00 €	7301850053	AR UNC 7/8-9-2A BS 919	153	100,00 €
7301940053	GR UNC 1 -8-2A BS 919	153	112,00 €	7301950053	AR UNC 1 -8-2A BS 919	153	112,00 €
7302040053	GR UNC 1 1/8-7-2A BS 919	153	130,00 €	7302050053	AR UNC 1 1/8-7-2A BS 919	153	130,00 €
7302140053	GR UNC 1 1/4-7-2A BS 919	153	143,00 €	7302150053	AR UNC 1 1/4-7-2A BS 919	153	171,00 €
7302240053	GR UNC 1 3/8-6-2A BS 919	153	157,00 €	7302250053	AR UNC 1 3/8-6-2A BS 919	153	157,00 €
7302340053	GR UNC 1 1/2-6-2A BS 919	153	169,00 €	7302350053	AR UNC 1 1/2-6-2A BS 919	153	169,00 €
7302440053	GR UNC 1 3/4-5-2A BS 919	153	197,00 €	7302450053	AR UNC 1 3/4-5-2A BS 919	153	197,00 €
7302540053	GR UNC 2 -4 1/2-2A BS 919	153	226,00 €	7302550053	AR UNC 2 -4 1/2-2A BS 919	153	226,00 €
7302640053	GR UNC 2 1/4-4 1/2-2A BS 919	153	257,00 €	7302650053	AR UNC 2 1/4-4 1/2-2A BS 919	153	257,00 €
7302740053	GR UNC 2 1/2-4-2A BS 919	153	289,00 €	7302750053	AR UNC 2 1/2-4-2A BS 919	153	289,00 €
7302840053	GR UNC 2 3/4-4-2A BS 919	153	320,00 €	7302850053	AR UNC 2 3/4-4-2A BS 919	153	320,00 €
7302940053	GR UNC 3 -4-2A BS 919	153	351,00 €	7302950053	AR UNC 3 -4-2A BS 919	153	351,00 €
7303040053	GR UNC 3 1/4-4-2A BS 919	153	383,00 €	7303050053	AR UNC 3 1/4-4-2A BS 919	153	383,00 €
7303140053	GR UNC 3 1/2-4-2A BS 919	153	414,00 €	7303150053	AR UNC 3 1/2-4-2A BS 919	153	414,00 €
7303240053	GR UNC 3 3/4-4-2A BS 919	153	443,00 €	7303250053	AR UNC 3 3/4-4-2A BS 919	153	443,00 €
7303340053	GR UNC 4 -4-2A BS 919	153	477,00 €	7303350053	AR UNC 4 -4-2A BS 919	153	477,00 €

ANr.	Beschreibung	AGr.	Einzelpreis	ANr.	Beschreibung	AGr.	Einzelpreis
<b>UNF - Unified Zollgewinde ANSI B1.1 - Lehrenmaße Gewindedorne ANSI B1.2 - Gewinderinge BS 919</b>							
91016811	GR UNF No. 0-80 BS 919 (0.060)	91	120,00 €	92016811	AR UNF No. 0-80 BS 919 (0.060)	92	120,00 €
91016911	GR UNF No. 1-72 BS 919 (0.073)	91	100,00 €	92016911	AR UNF No. 1-72 BS 919 (0.073)	92	100,00 €
91017011	GR UNF No. 2-64 BS 919 (0.086)	91	94,00 €	92017011	AR UNF No. 2-64 BS 919 (0.086)	92	94,00 €
91017111	GR UNF No. 3-56 BS 919 (0.099)	91	90,00 €	92017111	AR UNF No. 3-56 BS 919 (0.099)	92	90,00 €
91017211	GR UNF No. 4-48 BS 919 (0.112)	91	84,00 €	92017211	AR UNF No. 4-48 BS 919 (0.112)	92	84,00 €
91017311	GR UNF No. 5-44 BS 919 (0.125)	91	74,00 €	92017311	AR UNF No. 5-44 BS 919 (0.125)	92	74,00 €
91017411	GR UNF No. 6-40 BS 919 (0.138)	91	71,00 €	92017411	AR UNF No. 6-40 BS 919 (0.138)	92	71,00 €
91017511	GR UNF No. 8-36 BS 919 (0.164)	91	65,00 €	92017511	AR UNF No. 8-36 BS 919 (0.164)	92	65,00 €
91017611	GR UNF No.10-32 BS 919 (0.190)	91L	52,00 €	92017611	AR UNF No.10-32 BS 919 (0.190)	92L	52,00 €
91017711	GR UNF No.12-28 BS 919 (0.216)	91L	51,00 €	92017711	AR UNF No.12-28 BS 919 (0.216)	92L	51,00 €
91017811	GR UNF 1/4-28-2A BS 919	91L	51,00 €	92017811	AR UNF 1/4-28-2A BS 919	92L	51,00 €
91017911	GR UNF 5/16-24-2A BS 919	91L	54,00 €	92017911	AR UNF 5/16-24-2A BS 919	92L	54,00 €
91018011	GR UNF 3/8-24-2A BS 919	91L	58,00 €	92018011	AR UNF 3/8-24-2A BS 919	92L	58,00 €
91018111	GR UNF 7/16-20-2A BS 919	91L	62,00 €	92018111	AR UNF 7/16-20-2A BS 919	92L	62,00 €
91018211	GR UNF 1/2-20-2A BS 919	91L	70,00 €	92018211	AR UNF 1/2-20-2A BS 919	92L	70,00 €
7401640053	GR UNF 9/16-18-2A BS 919	153L	69,00 €	7401650053	AR UNF 9/16-18-2A BS 919	153L	69,00 €
7401740053	GR UNF 5/8-18-2A BS 919	153L	77,00 €	7401750053	AR UNF 5/8-18-2A BS 919	153L	77,00 €
7401840053	GR UNF 3/4-16-2A BS 919	153L	87,00 €	7401850053	AR UNF 3/4-16-2A BS 919	153L	87,00 €
7401940053	GR UNF 7/8-14-2A BS 919	153	100,00 €	7401950053	AR UNF 7/8-14-2A BS 919	153	100,00 €
7402040053	GR UNF 1-12-2A BS 919	153	112,00 €	7402050053	AR UNF 1-12-2A BS 919	153	112,00 €
7402140053	GR UNF 1 1/8-12-2A BS 919	153	129,00 €	7402150053	AR UNF 1 1/8-12-2A BS 919	153	129,00 €
7402240053	GR UNF 1 1/4-12-2A BS 919	153	143,00 €	7402250053	AR UNF 1 1/4-12-2A BS 919	153	143,00 €
7402340053	GR UNF 1 3/8-12-2A BS 919	153	157,00 €	7402350053	AR UNF 1 3/8-12-2A BS 919	153	157,00 €
7402440053	GR UNF 1 1/2-12-2A BS 919	153	169,00 €	7402450053	AR UNF 1 1/2-12-2A BS 919	153	169,00 €

<b>UNEF - Unified Zollgewinde ANSI B1.1 - Lehrenmaße Gewindedorne ANSI B1.2 - Gewinderinge BS 919</b>							
91Q19811	GR UNEF No.12-32 BS 919 (0.216)	91	74,00 €	92Q19811	AR UNEF No.12-32 BS 919 (0.216)	92	74,00 €
91Q19911	GR UNEF 1/4-32-2A BS 919 (0.250)	91	74,00 €	92Q19911	AR UNEF 1/4-32-2A BS 919 (0.250)	92	74,00 €
91Q20011	GR UNEF 5/16-32-2A BS 919 (0.3125)	91	79,00 €	92Q20011	AR UNEF 5/16-32-2A BS 919 (0.3125)	92	79,00 €
91Q20111	GR UNEF 3/8-32-2A BS 919 (0.375)	91	83,00 €	92Q20111	AR UNEF 3/8-32-2A BS 919 (0.375)	92	83,00 €
91Q20211	GR UNEF 7/16-28-2A BS 919 (0.4375)	91	87,00 €	92Q20211	AR UNEF 7/16-28-2A BS 919 (0.4375)	92	87,00 €
91Q20311	GR UNEF 1/2-28-2A BS 919 (0.500)	91	93,00 €	92Q20311	AR UNEF 1/2-28-2A BS 919 (0.500)	92	93,00 €
7940740053	GR UNEF 9/16-24-2A BS 919	153	74,00 €	7940750053	AR UNEF 9/16-24-2A BS 919	153	74,00 €
7940840053	GR UNEF 5/8-24-2A BS 919	153	81,00 €	7940850053	AR UNEF 5/8-24-2A BS 919	153	81,00 €
7940940053	GR UNEF 11/16-24-2A BS 919	153	89,00 €	7940950053	AR UNEF 11/16-24-2A BS 919	153	89,00 €
7941040053	GR UNEF 3/4-20-2A BS 919	153	94,00 €	7941050053	AR UNEF 3/4-20-2A BS 919	153	94,00 €
7941140053	GR UNEF 13/16-20-2A BS 919	153	101,00 €	7941150053	AR UNEF 13/16-20-2A BS 919	153	101,00 €
7941240053	GR UNEF 7/8-20-2A BS 919	153	109,00 €	7941250053	AR UNEF 7/8-20-2A BS 919	153	109,00 €
7941340053	GR UNEF 15/16-20-2A BS 919	153	116,00 €	7941350053	AR UNEF 15/16-20-2A BS 919	153	116,00 €
7941440053	GR UNEF 1-20-2A BS 919	153	121,00 €	7941450053	AR UNEF 1-20-2A BS 919	153	121,00 €
7941540053	GR UNEF 1 1/16-18-2A BS 919	153	129,00 €	7941550053	AR UNEF 1 1/16-18-2A BS 919	153	129,00 €
7941640053	GR UNEF 1 1/8-18-2A BS 919	153	134,00 €	7941650053	AR UNEF 1 1/8-18-2A BS 919	153	134,00 €
7941740053	GR UNEF 1 3/16-18-2A BS 919	153	143,00 €	7941750053	AR UNEF 1 3/16-18-2A BS 919	153	143,00 €

ANr.	Beschreibung	AGr.	Einzelpreis	ANr.	Beschreibung	AGr.	Einzelpreis
<b>UNEF - Unified Zollgewinde ANSI B1.1 - Lehrenmaße Gewindedorne ANSI B1.2 - Gewinderinge BS 919</b>							
7941840053	<b>GR UNEF 1 1/4-18-2A BS 919</b>	153	<b>149,00 €</b>	7941850053	<b>AR UNEF 1 1/4-18-2A BS 919</b>	153	<b>149,00 €</b>
7941940053	<b>GR UNEF 1 5/16-18-2A BS 919</b>	153	<b>154,00 €</b>	7941950053	<b>AR UNEF 1 5/16-18-2A BS 919</b>	153	<b>154,00 €</b>
7942040053	<b>GR UNEF 1 3/8-18-2A BS 919</b>	153	<b>163,00 €</b>	7942050053	<b>AR UNEF 1 3/8-18-2A BS 919</b>	153	<b>163,00 €</b>
7942140053	<b>GR UNEF 1 7/16-18-2A BS 919</b>	153	<b>171,00 €</b>	7942150053	<b>AR UNEF 1 7/16-18-2A BS 919</b>	153	<b>171,00 €</b>
7942240053	<b>GR UNEF 1 1/2-18-2A BS 919</b>	153	<b>177,00 €</b>	7942250053	<b>AR UNEF 1 1/2-18-2A BS 919</b>	153	<b>177,00 €</b>
7942340053	<b>GR UNEF 1 9/16-18-2A BS 919</b>	153	<b>183,00 €</b>	7942350053	<b>AR UNEF 1 9/16-18-2A BS 919</b>	153	<b>183,00 €</b>
7942440053	<b>GR UNEF 1 5/8-18-2A BS 919</b>	153	<b>189,00 €</b>	7942450053	<b>AR UNEF 1 5/8-18-2A BS 919</b>	153	<b>189,00 €</b>
7942540053	<b>GR UNEF 1 11/16-18-2A BS 919</b>	153	<b>129,00 €</b>	7942550053	<b>AR UNEF 1 11/16-18-2A BS 919</b>	153	<b>200,00 €</b>

ANr.	Beschreibung	AGr.	Einzelpreis	ANr.	Beschreibung	AGr.	Einzelpreis
------	--------------	------	-------------	------	--------------	------	-------------

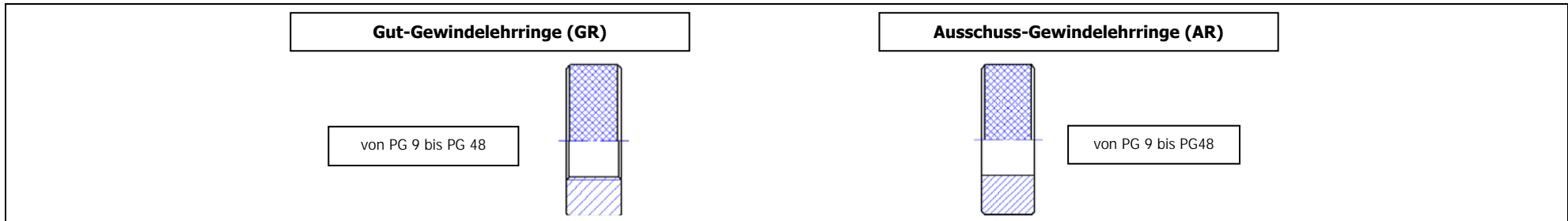

Stahlpanzerrohrgewinde DIN 40430							
7600240053	<b>GR PG 9 DIN 40430</b>	153L	<b>97,00 €</b>	7600250053	<b>AR PG 9 DIN 40430</b>	153L	<b>43,00 €</b>
7600340053	<b>GR PG 11 DIN 40430</b>	153L	<b>109,00 €</b>	7600350053	<b>AR PG 11 DIN 40430</b>	153L	<b>46,00 €</b>
7600440053	<b>GR PG 13,5 DIN 40430</b>	153L	<b>114,00 €</b>	7600450053	<b>AR PG 13,5 DIN 40430</b>	153L	<b>49,00 €</b>
7600540053	<b>GR PG 16 DIN 40430</b>	153L	<b>123,00 €</b>	7600550053	<b>AR PG 16 DIN 40430</b>	153L	<b>50,00 €</b>
7600640053	<b>GR PG 21 DIN 40430</b>	153L	<b>149,00 €</b>	7600650053	<b>AR PG 21 DIN 40430</b>	153L	<b>53,00 €</b>
7600740053	<b>GR PG 29 DIN 40430</b>	153L	<b>189,00 €</b>	7600750053	<b>AR PG 29 DIN 40430</b>	153L	<b>56,00 €</b>
7600840053	<b>GR PG 36 DIN 40430</b>	153L	<b>234,00 €</b>	7600850053	<b>AR PG 36 DIN 40430</b>	153L	<b>63,00 €</b>
7600940053	<b>GR PG 42 DIN 40430</b>	153L	<b>266,00 €</b>	7600950053	<b>AR PG 42 DIN 40430</b>	153L	<b>77,00 €</b>
7601040053	<b>GR PG 48 DIN 40430</b>	153L	<b>289,00 €</b>	7601050053	<b>AR PG 48 DIN 40430</b>	153L	<b>83,00 €</b>

Elektrogewinde DIN 40400							
7680440053	<b>GR E 16 DIN 40400</b>	153	<b>427,00 €</b>	7680450053	<b>AR E 16 DIN 40400</b>	153	<b>86,00 €</b>
7680540053	<b>GR E 18 DIN 40400</b>	153	<b>479,00 €</b>	7680550053	<b>AR E 18 DIN 40400</b>	153	<b>92,00 €</b>
7680640053	<b>GR E 27 DIN 40400</b>	153	<b>596,00 €</b>	7680650053	<b>AR E 27 DIN 40400</b>	153	<b>105,00 €</b>
7680740053	<b>GR E 33 DIN 40400</b>	153	<b>671,00 €</b>	7680750053	<b>AR E 33 DIN 40400</b>	153	<b>115,00 €</b>
7680840053	<b>GR E 40 DIN 40400</b>	153	<b>1.003,00 €</b>	7680850053	<b>AR E 40 DIN 40400</b>	153	<b>252,00 €</b>

ANr.	Beschreibung	AGr.	Einzelpreis	ANr.	Beschreibung	AGr.	Einzelpreis
------	--------------	------	-------------	------	--------------	------	-------------

Grenz-Gewindeherringe für kegelige Gewinde (GLR)

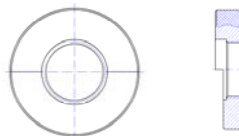

**Whitworth Rohrgewinde DIN 2999 · Gewindegrenzlehrdorne keglig · Gewindegrenzlehrringe zylindrisch**

93U2201M	<b>GLR R 1/8 DIN 2999</b>	93L	<b>149,00 €</b>				
93U2211M	<b>GLR R 1/4 DIN 2999</b>	93L	<b>163,00 €</b>				
7700340053	<b>GLR R 3/8 DIN 2999</b>	153L	<b>147,00 €</b>				
7700440053	<b>GLR R 1/2 DIN 2999</b>	153L	<b>170,00 €</b>				
7700540053	<b>GLR R 3/4 DIN 2999</b>	153L	<b>197,00 €</b>				
7700640053	<b>GLR R 1 DIN 2999</b>	153L	<b>214,00 €</b>				
7700740053	<b>GLR R 1 1/4 DIN 2999</b>	153	<b>254,00 €</b>				
7700840053	<b>GLR R 1 1/2 DIN 2999</b>	153L	<b>309,00 €</b>				
7700940053	<b>GLR R 2 DIN 2999</b>	153L	<b>346,00 €</b>				
7701040053	<b>GLR R 2 1/2 DIN 2999</b>	153L	<b>380,00 €</b>				
7701140053	<b>GLR R 3 DIN 2999</b>	153	<b>411,00 €</b>				
7701240053	<b>GLR R 4 DIN 2999</b>	153	<b>494,00 €</b>				
7701340053	<b>GLR R 5 DIN 2999</b>	153	<b>603,00 €</b>				
7701440053	<b>GLR R 6 DIN 2999</b>	153	<b>723,00 €</b>				

ANr.	Beschreibung	AGr.	Einzelpreis	ANr.	Beschreibung	AGr.	Einzelpreis
------	--------------	------	-------------	------	--------------	------	-------------

Grenz-Gewindeherringe für kegelige Gewinde (GLR)

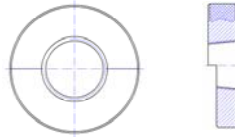

**Kegeliges Amerikanisches Rohrgewinde NPT - Gewindegrenzlehndorne keglig - Gewindegrenzlehrringe keglig**

93V2141M	GLR NPT 1/16-27	93	341,00 €
93V2151M	GLR NPT 1/8-27	93L	349,00 €
93V2161M	GLR NPT 1/4-18	93L	367,00 €
7500440053	GLR NPT 3/8-18	153L	275,00 €
7500540053	GLR NPT 1/2-14	153L	299,00 €
7500640053	GLR NPT 3/4-14	153L	323,00 €
7500740053	GLR NPT 1-11 1/2	153L	366,00 €
7500840053	GLR NPT 1 1/4-11 1/2	153	429,00 €
7500940053	GLR NPT 1 1/2-11 1/2	153L	474,00 €
7501040053	GLR NPT 2-11 1/2	153L	580,00 €
7501140053	GLR NPT 2 1/2-8	153	663,00 €
7501240053	GLR NPT 3-8	153	849,00 €
7501340053	GLR NPT 3 1/2-8	153	1.051,00 €
7501440053	GLR NPT 4-8	153	1.260,00 €
7501540053	GLR NPT 5-8	153	1.555,00 €
7501640053	GLR NPT 6-8	153	1.866,00 €

**Kegeliges Amerikanisches Rohrgewinde NPTF - Gewindegrenzlehndorne keglig - Gewindegrenzlehrringe keglig**

93W2171M	GLR NPTF 1/16-27	93	341,00 €
93W2181M	GLR NPTF 1/8-27	93	349,00 €
93W2191M	GLR NPTF 1/4-18	93	367,00 €
7500441053	GLR NPTF 3/8-18	153	330,00 €
7500541053	GLR NPTF 1/2-14	153	321,00 €
7500641053	GLR NPTF 3/4-14	153	323,00 €
7500741053	GLR NPTF 1-11 1/2	153	366,00 €
7500841053	GLR NPTF 1 1/4-11 1/2	153	429,00 €
7500941053	GLR NPTF 1 1/2-11 1/2	153	474,00 €
7501041053	GLR NPTF 2-11 1/2	153	580,00 €
7501141053	GLR NPTF 2 1/2-8	153	663,00 €
7501241053	GLR NPTF 3-8	153	849,00 €



Anr.	Beschreibung	AGr.	Einzelpreis	Anr.	Beschreibung	AGr.	Einzelpreis	Anr.	Beschreibung	AGr.	Einzelpreis
------	--------------	------	-------------	------	--------------	------	-------------	------	--------------	------	-------------

Grenzlehdorne, LS (Z-GLD-LS)



von Nenndurchmesser 1 bis 100 mm

Grenzlehdorne, LS, ohne ZM, Passung H7				Grenzlehdorne, LS, ohne ZM, andere Passungen				Grenzlehdorne, LS, mit ZM			
8AA0010011	Z-GLD-LS-H7-1	8AA	38,00 €	8AA0010014	Z-GLD-LS-And-1	8AA	41,00 €	8AA0010012	Z-GLD-LS-ZM-1	8AA	68,00 €
8AA0012011	Z-GLD-LS-H7-1,2	8AA	35,00 €	8AA0012014	Z-GLD-LS-And-1,2	8AA	38,00 €	8AA0012012	Z-GLD-LS-ZM-1,2	8AA	68,00 €
8AA0015011	Z-GLD-LS-H7-1,5	8AA	35,00 €	8AA0015014	Z-GLD-LS-And-1,5	8AA	38,00 €	8AA0015012	Z-GLD-LS-ZM-1,5	8AA	68,00 €
8AA0018011	Z-GLD-LS-H7-1,8	8AA	35,00 €	8AA0018014	Z-GLD-LS-And-1,8	8AA	38,00 €	8AA0018012	Z-GLD-LS-ZM-1,8	8AA	68,00 €
8AA0020011	Z-GLD-LS-H7-2	8AAL	25,00 €	8AA0020014	Z-GLD-LS-And-2	8AA	33,00 €	8AA0020012	Z-GLD-LS-ZM-2	8AA	62,00 €
8AA0022011	Z-GLD-LS-H7-2,2	8AA	31,00 €	8AA0022014	Z-GLD-LS-And-2,2	8AA	33,00 €	8AA0022012	Z-GLD-LS-ZM-2,2	8AA	62,00 €
8AA0025011	Z-GLD-LS-H7-2,5	8AA	31,00 €	8AA0025014	Z-GLD-LS-And-2,5	8AA	33,00 €	8AA0025012	Z-GLD-LS-ZM-2,5	8AA	62,00 €
8AA0028011	Z-GLD-LS-H7-2,8	8AA	27,00 €	8AA0028014	Z-GLD-LS-And-2,8	8AA	29,00 €	8AA0028012	Z-GLD-LS-ZM-2,8	8AA	55,00 €
8AA0030011	Z-GLD-LS-H7-3	8AAL	22,00 €	8AA0030014	Z-GLD-LS-And-3	8AA	29,00 €	8AA0030012	Z-GLD-LS-ZM-3	8AA	55,00 €
8AA0035011	Z-GLD-LS-H7-3,5	8AA	24,00 €	8AA0035014	Z-GLD-LS-And-3,5	8AA	26,00 €	8AA0035012	Z-GLD-LS-ZM-3,5	8AA	47,00 €
8AA0040011	Z-GLD-LS-H7-4	8AAL	20,00 €	8AA0040014	Z-GLD-LS-And-4	8AA	26,00 €	8AA0040012	Z-GLD-LS-ZM-4	8AA	47,00 €
8AA0045011	Z-GLD-LS-H7-4,5	8AA	24,00 €	8AA0045014	Z-GLD-LS-And-4,5	8AA	26,00 €	8AA0045012	Z-GLD-LS-ZM-4,5	8AA	47,00 €
8AA0050011	Z-GLD-LS-H7-5	8AAL	18,00 €	8AA0050014	Z-GLD-LS-And-5	8AA	25,00 €	8AA0050012	Z-GLD-LS-ZM-5	8AA	41,00 €
8AA0055011	Z-GLD-LS-H7-5,5	8AA	23,00 €	8AA0055014	Z-GLD-LS-And-5,5	8AA	25,00 €	8AA0055012	Z-GLD-LS-ZM-5,5	8AA	41,00 €
8AA0060011	Z-GLD-LS-H7-6	8AAL	18,00 €	8AA0060014	Z-GLD-LS-And-6	8AA	25,00 €	8AA0060012	Z-GLD-LS-ZM-6	8AA	41,00 €
8AA0070011	Z-GLD-LS-H7-7	8AAL	19,00 €	8AA0070014	Z-GLD-LS-And-7	8AA	25,00 €	8AA0070012	Z-GLD-LS-ZM-7	8AA	43,00 €
8AA0080011	Z-GLD-LS-H7-8	8AAL	20,00 €	8AA0080014	Z-GLD-LS-And-8	8AA	26,00 €	8AA0080012	Z-GLD-LS-ZM-8	8AA	44,00 €
8AA0090011	Z-GLD-LS-H7-9	8AAL	20,00 €	8AA0090014	Z-GLD-LS-And-9	8AA	27,00 €	8AA0090012	Z-GLD-LS-ZM-9	8AA	46,00 €
8AA0100011	Z-GLD-LS-H7-10	8AAL	21,00 €	8AA0100014	Z-GLD-LS-And-10	8AA	28,00 €	8AA0100012	Z-GLD-LS-ZM-10	8AA	47,00 €
8AA0110011	Z-GLD-LS-H7-11	8AAL	22,00 €	8AA0110014	Z-GLD-LS-And-11	8AA	29,00 €	8AA0110012	Z-GLD-LS-ZM-11	8AA	49,00 €
8AA0120011	Z-GLD-LS-H7-12	8AAL	22,00 €	8AA0120014	Z-GLD-LS-And-12	8AA	30,00 €	8AA0120012	Z-GLD-LS-ZM-12	8AA	50,00 €
8AA0130011	Z-GLD-LS-H7-13	8AAL	23,00 €	8AA0130014	Z-GLD-LS-And-13	8AA	31,00 €	8AA0130012	Z-GLD-LS-ZM-13	8AA	52,00 €
8AA0140011	Z-GLD-LS-H7-14	8AAL	24,00 €	8AA0140014	Z-GLD-LS-And-14	8AA	32,00 €	8AA0140012	Z-GLD-LS-ZM-14	8AA	53,00 €
8AA0150011	Z-GLD-LS-H7-15	8AAL	24,00 €	8AA0150014	Z-GLD-LS-And-15	8AA	33,00 €	8AA0150012	Z-GLD-LS-ZM-15	8AA	55,00 €
8AA0160011	Z-GLD-LS-H7-16	8AAL	25,00 €	8AA0160014	Z-GLD-LS-And-16	8AA	33,00 €	8AA0160012	Z-GLD-LS-ZM-16	8AA	56,00 €
8AA0170011	Z-GLD-LS-H7-17	8AAL	26,00 €	8AA0170014	Z-GLD-LS-And-17	8AA	34,00 €	8AA0170012	Z-GLD-LS-ZM-17	8AA	57,00 €
8AA0180011	Z-GLD-LS-H7-18	8AAL	26,00 €	8AA0180014	Z-GLD-LS-And-18	8AA	35,00 €	8AA0180012	Z-GLD-LS-ZM-18	8AA	59,00 €
8AA0190011	Z-GLD-LS-H7-19	8AAL	27,00 €	8AA0190014	Z-GLD-LS-And-19	8AA	36,00 €	8AA0190012	Z-GLD-LS-ZM-19	8AA	62,00 €
8AA0200011	Z-GLD-LS-H7-20	8AAL	27,00 €	8AA0200014	Z-GLD-LS-And-20	8AA	36,00 €	8AA0200012	Z-GLD-LS-ZM-20	8AA	62,00 €
8AA0210011	Z-GLD-LS-H7-21	8AAL	28,00 €	8AA0210014	Z-GLD-LS-And-21	8AA	38,00 €	8AA0210012	Z-GLD-LS-ZM-21	8AA	63,00 €
8AA0220011	Z-GLD-LS-H7-22	8AAL	29,00 €	8AA0220014	Z-GLD-LS-And-22	8AA	39,00 €	8AA0220012	Z-GLD-LS-ZM-22	8AA	65,00 €
8AA0230011	Z-GLD-LS-H7-23	8AAL	30,00 €	8AA0230014	Z-GLD-LS-And-23	8AA	40,00 €	8AA0230012	Z-GLD-LS-ZM-23	8AA	66,00 €
8AA0240011	Z-GLD-LS-H7-24	8AAL	30,00 €	8AA0240014	Z-GLD-LS-And-24	8AA	41,00 €	8AA0240012	Z-GLD-LS-ZM-24	8AA	68,00 €
8AA0250011	Z-GLD-LS-H7-25	8AAL	31,00 €	8AA0250014	Z-GLD-LS-And-25	8AA	41,00 €	8AA0250012	Z-GLD-LS-ZM-25	8AA	69,00 €



ANr.	Beschreibung	AGr.	Einzelpreis	ANr.	Beschreibung	AGr.	Einzelpreis	ANr.	Beschreibung	AGr.	Einzelpreis
<b>Grenzlehrdorne, LS, ohne ZM, Passung H7</b>			<b>Grenzlehrdorne, LS, ohne ZM, andere Passungen</b>				<b>Grenzlehrdorne, LS, mit ZM</b>				
8AA0260011	Z-GLD-LS-H7-26	8AAL	32,00 €	8AA0260014	Z-GLD-LS-And-26	8AA	42,00 €	8AA0260012	Z-GLD-LS-ZM-26	8AA	71,00 €
8AA0270011	Z-GLD-LS-H7-27	8AAL	32,00 €	8AA0270014	Z-GLD-LS-And-27	8AA	43,00 €	8AA0270012	Z-GLD-LS-ZM-27	8AA	82,00 €
8AA0280011	Z-GLD-LS-H7-28	8AAL	33,00 €	8AA0280014	Z-GLD-LS-And-28	8AA	44,00 €	8AA0280012	Z-GLD-LS-ZM-28	8AA	74,00 €
8AA0300011	Z-GLD-LS-H7-30	8AAL	34,00 €	8AA0300014	Z-GLD-LS-And-30	8AA	45,00 €	8AA0300012	Z-GLD-LS-ZM-30	8AA	79,00 €
8AA0320011	Z-GLD-LS-H7-32	8AAL	37,00 €	8AA0320014	Z-GLD-LS-And-32	8AA	49,00 €	8AA0320012	Z-GLD-LS-ZM-32	8AA	82,00 €
8AA0330011	Z-GLD-LS-H7-33	8AAL	38,00 €	8AA0330014	Z-GLD-LS-And-33	8AA	50,00 €	8AA0330012	Z-GLD-LS-ZM-33	8AA	84,00 €
8AA0340011	Z-GLD-LS-H7-34	8AAL	39,00 €	8AA0340014	Z-GLD-LS-And-34	8AA	51,00 €	8AA0340012	Z-GLD-LS-ZM-34	8AA	85,00 €
8AA0350011	Z-GLD-LS-H7-35	8AAL	39,00 €	8AA0350014	Z-GLD-LS-And-35	8AA	52,00 €	8AA0350012	Z-GLD-LS-ZM-35	8AA	87,00 €
8AA0360011	Z-GLD-LS-H7-36	8AAL	40,00 €	8AA0360014	Z-GLD-LS-And-36	8AA	53,00 €	8AA0360012	Z-GLD-LS-ZM-36	8AA	88,00 €
8AA0370011	Z-GLD-LS-H7-37	8AAL	41,00 €	8AA0370014	Z-GLD-LS-And-37	8AA	54,00 €	8AA0370012	Z-GLD-LS-ZM-37	8AA	91,00 €
8AA0380011	Z-GLD-LS-H7-38	8AAL	42,00 €	8AA0380014	Z-GLD-LS-And-38	8AA	56,00 €	8AA0380012	Z-GLD-LS-ZM-38	8AA	94,00 €
8AA0400011	Z-GLD-LS-H7-40	8AAL	43,00 €	8AA0400014	Z-GLD-LS-And-40	8AA	57,00 €	8AA0400012	Z-GLD-LS-ZM-40	8AA	97,00 €
8AA0420011	Z-GLD-LS-H7-42	8AAL	45,00 €	8AA0420014	Z-GLD-LS-And-42	8AA	59,00 €	8AA0420012	Z-GLD-LS-ZM-42	8AA	103,00 €
8AA0440011	Z-GLD-LS-H7-44	8AAL	47,00 €	8AA0440014	Z-GLD-LS-And-44	8AA	63,00 €	8AA0440012	Z-GLD-LS-ZM-44	8AA	106,00 €
8AA0450011	Z-GLD-LS-H7-45	8AAL	49,00 €	8AA0450014	Z-GLD-LS-And-45	8AA	65,00 €	8AA0450012	Z-GLD-LS-ZM-45	8AA	109,00 €
8AA0460011	Z-GLD-LS-H7-46	8AAL	50,00 €	8AA0460014	Z-GLD-LS-And-46	8AA	66,00 €	8AA0460012	Z-GLD-LS-ZM-46	8AA	112,00 €
8AA0470011	Z-GLD-LS-H7-47	8AAL	52,00 €	8AA0470014	Z-GLD-LS-And-47	8AA	68,00 €	8AA0470012	Z-GLD-LS-ZM-47	8AA	115,00 €
8AA0480011	Z-GLD-LS-H7-48	8AAL	53,00 €	8AA0480014	Z-GLD-LS-And-48	8AA	70,00 €	8AA0480012	Z-GLD-LS-ZM-48	8AA	118,00 €
8AA0500011	Z-GLD-LS-H7-50	8AAL	54,00 €	8AA0500014	Z-GLD-LS-And-50	8AA	72,00 €	8AA0500012	Z-GLD-LS-ZM-50	8AA	123,00 €
8AA0520011	Z-GLD-LS-H7-52	8AA	66,00 €	8AA0520014	Z-GLD-LS-And-52	8AA	75,00 €	8AA0520012	Z-GLD-LS-ZM-52	8AA	129,00 €
8AA0550011	Z-GLD-LS-H7-55	8AA	66,00 €	8AA0550014	Z-GLD-LS-And-55	8AA	79,00 €	8AA0550012	Z-GLD-LS-ZM-55	8AA	138,00 €
8AA0580011	Z-GLD-LS-H7-58	8AA	67,00 €	8AA0580014	Z-GLD-LS-And-58	8AA	84,00 €	8AA0580012	Z-GLD-LS-ZM-58	8AA	144,00 €
8AA0600011	Z-GLD-LS-H7-60	8AA	67,00 €	8AA0600014	Z-GLD-LS-And-60	8AA	88,00 €	8AA0600012	Z-GLD-LS-ZM-60	8AA	150,00 €
8AA0620011	Z-GLD-LS-H7-62	8AA	78,00 €	8AA0620014	Z-GLD-LS-And-62	8AA	91,00 €	8AA0620012	Z-GLD-LS-ZM-62	8AA	154,00 €
8AA0650011	Z-GLD-LS-H7-65	8AA	78,00 €	8AA0650014	Z-GLD-LS-And-65	8AA	94,00 €	8AA0650012	Z-GLD-LS-ZM-65	8AA	164,00 €
8AA0680011	Z-GLD-LS-H7-68	8AA	82,00 €	8AA0680014	Z-GLD-LS-And-68	8AA	100,00 €	8AA0680012	Z-GLD-LS-ZM-68	8AA	167,00 €
8AA0700011	Z-GLD-LS-H7-70	8AA	82,00 €	8AA0700014	Z-GLD-LS-And-70	8AA	102,00 €	8AA0700012	Z-GLD-LS-ZM-70	8AA	175,00 €
8AA0720011	Z-GLD-LS-H7-72	8AA	95,00 €	8AA0720014	Z-GLD-LS-And-72	8AA	106,00 €	8AA0720012	Z-GLD-LS-ZM-72	8AA	182,00 €
8AA0750011	Z-GLD-LS-H7-75	8AA	95,00 €	8AA0750014	Z-GLD-LS-And-75	8AA	111,00 €	8AA0750012	Z-GLD-LS-ZM-75	8AA	191,00 €
8AA0780011	Z-GLD-LS-H7-78	8AA	99,00 €	8AA0780014	Z-GLD-LS-And-78	8AA	116,00 €	8AA0780012	Z-GLD-LS-ZM-78	8AA	194,00 €
8AA0800011	Z-GLD-LS-H7-80	8AA	99,00 €	8AA0800014	Z-GLD-LS-And-80	8AA	118,00 €	8AA0800012	Z-GLD-LS-ZM-80	8AA	199,00 €
8AA0820011	Z-GLD-LS-H7-82	8AA	105,00 €	8AA0820014	Z-GLD-LS-And-82	8AA	122,00 €	8AA0820012	Z-GLD-LS-ZM-82	8AA	205,00 €
8AA0850011	Z-GLD-LS-H7-85	8AA	105,00 €	8AA0850014	Z-GLD-LS-And-85	8AA	125,00 €	8AA0850012	Z-GLD-LS-ZM-85	8AA	214,00 €
8AA0880011	Z-GLD-LS-H7-88	8AA	109,00 €	8AA0880014	Z-GLD-LS-And-88	8AA	130,00 €	8AA0880012	Z-GLD-LS-ZM-88	8AA	220,00 €
8AA0900011	Z-GLD-LS-H7-90	8AA	109,00 €	8AA0900014	Z-GLD-LS-And-90	8AA	134,00 €	8AA0900012	Z-GLD-LS-ZM-90	8AA	226,00 €
8AA0920011	Z-GLD-LS-H7-92	8AA	119,00 €	8AA0920014	Z-GLD-LS-And-92	8AA	138,00 €	8AA0920012	Z-GLD-LS-ZM-92	8AA	232,00 €
8AA0950011	Z-GLD-LS-H7-95	8AA	119,00 €	8AA0950014	Z-GLD-LS-And-95	8AA	141,00 €	8AA0950012	Z-GLD-LS-ZM-95	8AA	241,00 €
8AA0980011	Z-GLD-LS-H7-98	8AA	124,00 €	8AA0980014	Z-GLD-LS-And-98	8AA	147,00 €	8AA0980012	Z-GLD-LS-ZM-98	8AA	246,00 €
8AA1000011	Z-GLD-LS-H7-100	8AA	124,00 €	8AA1000014	Z-GLD-LS-And-100	8AA	150,00 €	8AA1000012	Z-GLD-LS-ZM-100	8AA	253,00 €

ANr.	Beschreibung	AGr.	Einzelpreis	ANr.	Beschreibung	AGr.	Einzelpreis	ANr.	Beschreibung	AGr.	Einzelpreis
------	--------------	------	-------------	------	--------------	------	-------------	------	--------------	------	-------------

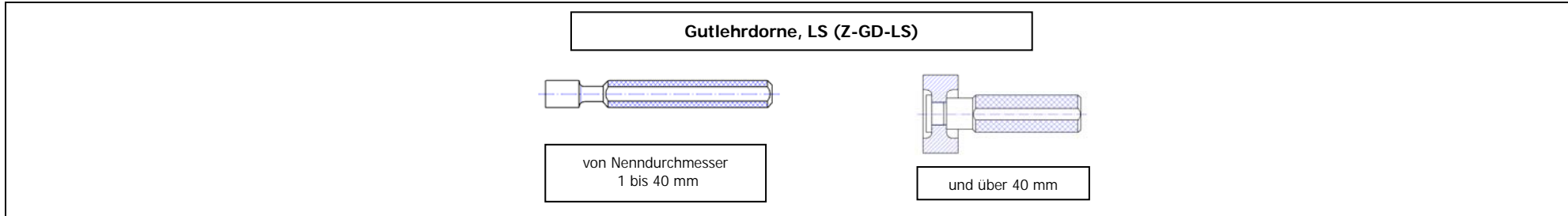

Gutlehdorne, LS, ohne ZM, Passung H7				Gutlehdorne, LS, ohne ZM, andere Passungen				Gutlehdorne, LS, mit ZM			
8AB0010011	Z-GD-LS-H7-1	8AB	23,00 €	8AB0010014	Z-GD-LS-And-1	8AB	25,00 €	8AB0010012	Z-GD-LS-ZM-1	8AB	41,00 €
8AB0012011	Z-GD-LS-H7-1,2	8AB	21,00 €	8AB0012014	Z-GD-LS-And-1,2	8AB	23,00 €	8AB0012012	Z-GD-LS-ZM-1,2	8AB	41,00 €
8AB0015011	Z-GD-LS-H7-1,5	8AB	21,00 €	8AB0015014	Z-GD-LS-And-1,5	8AB	23,00 €	8AB0015012	Z-GD-LS-ZM-1,5	8AB	41,00 €
8AB0018011	Z-GD-LS-H7-1,8	8AB	21,00 €	8AB0018014	Z-GD-LS-And-1,8	8AB	23,00 €	8AB0018012	Z-GD-LS-ZM-1,8	8AB	41,00 €
8AB0020011	Z-GD-LS-H7-2	8AB	19,00 €	8AB0020014	Z-GD-LS-And-2	8AB	20,00 €	8AB0020012	Z-GD-LS-ZM-2	8AB	37,00 €
8AB0022011	Z-GD-LS-H7-2,2	8AB	19,00 €	8AB0022014	Z-GD-LS-And-2,2	8AB	20,00 €	8AB0022012	Z-GD-LS-ZM-2,2	8AB	37,00 €
8AB0025011	Z-GD-LS-H7-2,5	8AB	19,00 €	8AB0025014	Z-GD-LS-And-2,5	8AB	20,00 €	8AB0025012	Z-GD-LS-ZM-2,5	8AB	37,00 €
8AB0028011	Z-GD-LS-H7-2,8	8AB	16,00 €	8AB0028014	Z-GD-LS-And-2,8	8AB	17,00 €	8AB0028012	Z-GD-LS-ZM-2,8	8AB	33,00 €
8AB0030011	Z-GD-LS-H7-3	8AB	14,00 €	8AB0030014	Z-GD-LS-And-3	8AB	17,00 €	8AB0030012	Z-GD-LS-ZM-3	8AB	33,00 €
8AB0035011	Z-GD-LS-H7-3,5	8AB	14,00 €	8AB0035014	Z-GD-LS-And-3,5	8AB	16,00 €	8AB0035012	Z-GD-LS-ZM-3,5	8AB	28,00 €
8AB0040011	Z-GD-LS-H7-4	8AB	14,00 €	8AB0040014	Z-GD-LS-And-4	8AB	16,00 €	8AB0040012	Z-GD-LS-ZM-4	8AB	28,00 €
8AB0045011	Z-GD-LS-H7-4,5	8AB	14,00 €	8AB0045014	Z-GD-LS-And-4,5	8AB	16,00 €	8AB0045012	Z-GD-LS-ZM-4,5	8AB	28,00 €
8AB0050011	Z-GD-LS-H7-5	8AB	14,00 €	8AB0050014	Z-GD-LS-And-5	8AB	15,00 €	8AB0050012	Z-GD-LS-ZM-5	8AB	25,00 €
8AB0055011	Z-GD-LS-H7-5,5	8AB	14,00 €	8AB0055014	Z-GD-LS-And-5,5	8AB	15,00 €	8AB0055012	Z-GD-LS-ZM-5,5	8AB	25,00 €
8AB0060011	Z-GD-LS-H7-6	8AB	13,00 €	8AB0060014	Z-GD-LS-And-6	8AB	15,00 €	8AB0060012	Z-GD-LS-ZM-6	8AB	25,00 €
8AB0070011	Z-GD-LS-H7-7	8AB	13,00 €	8AB0070014	Z-GD-LS-And-7	8AB	15,00 €	8AB0070012	Z-GD-LS-ZM-7	8AB	26,00 €
8AB0080011	Z-GD-LS-H7-8	8AB	13,00 €	8AB0080014	Z-GD-LS-And-8	8AB	16,00 €	8AB0080012	Z-GD-LS-ZM-8	8AB	28,00 €
8AB0090011	Z-GD-LS-H7-9	8AB	13,00 €	8AB0090014	Z-GD-LS-And-9	8AB	16,00 €	8AB0090012	Z-GD-LS-ZM-9	8AB	28,00 €
8AB0100011	Z-GD-LS-H7-10	8AB	13,00 €	8AB0100014	Z-GD-LS-And-10	8AB	17,00 €	8AB0100012	Z-GD-LS-ZM-10	8AB	29,00 €
8AB0110011	Z-GD-LS-H7-11	8AB	13,00 €	8AB0110014	Z-GD-LS-And-11	8AB	17,00 €	8AB0110012	Z-GD-LS-ZM-11	8AB	29,00 €
8AB0120011	Z-GD-LS-H7-12	8AB	13,00 €	8AB0120014	Z-GD-LS-And-12	8AB	18,00 €	8AB0120012	Z-GD-LS-ZM-12	8AB	30,00 €
8AB0130011	Z-GD-LS-H7-13	8AB	14,00 €	8AB0130014	Z-GD-LS-And-13	8AB	19,00 €	8AB0130012	Z-GD-LS-ZM-13	8AB	31,00 €
8AB0140011	Z-GD-LS-H7-14	8AB	14,00 €	8AB0140014	Z-GD-LS-And-14	8AB	19,00 €	8AB0140012	Z-GD-LS-ZM-14	8AB	32,00 €
8AB0150011	Z-GD-LS-H7-15	8AB	14,00 €	8AB0150014	Z-GD-LS-And-15	8AB	20,00 €	8AB0150012	Z-GD-LS-ZM-15	8AB	33,00 €
8AB0160011	Z-GD-LS-H7-16	8AB	24,00 €	8AB0160014	Z-GD-LS-And-16	8AB	20,00 €	8AB0160012	Z-GD-LS-ZM-16	8AB	34,00 €
8AB0170011	Z-GD-LS-H7-17	8AB	19,00 €	8AB0170014	Z-GD-LS-And-17	8AB	20,00 €	8AB0170012	Z-GD-LS-ZM-17	8AB	35,00 €
8AB0180011	Z-GD-LS-H7-18	8AB	19,00 €	8AB0180014	Z-GD-LS-And-18	8AB	21,00 €	8AB0180012	Z-GD-LS-ZM-18	8AB	35,00 €
8AB0190011	Z-GD-LS-H7-19	8AB	19,00 €	8AB0190014	Z-GD-LS-And-19	8AB	22,00 €	8AB0190012	Z-GD-LS-ZM-19	8AB	37,00 €
8AB0200011	Z-GD-LS-H7-20	8AB	19,00 €	8AB0200014	Z-GD-LS-And-20	8AB	22,00 €	8AB0200012	Z-GD-LS-ZM-20	8AB	37,00 €
8AB0210011	Z-GD-LS-H7-21	8AB	20,00 €	8AB0210014	Z-GD-LS-And-21	8AB	23,00 €	8AB0210012	Z-GD-LS-ZM-21	8AB	38,00 €
8AB0220011	Z-GD-LS-H7-22	8AB	20,00 €	8AB0220014	Z-GD-LS-And-22	8AB	23,00 €	8AB0220012	Z-GD-LS-ZM-22	8AB	39,00 €
8AB0230011	Z-GD-LS-H7-23	8AB	20,00 €	8AB0230014	Z-GD-LS-And-23	8AB	24,00 €	8AB0230012	Z-GD-LS-ZM-23	8AB	40,00 €

ANr.	Beschreibung	AGr.	Einzelpreis	ANr.	Beschreibung	AGr.	Einzelpreis	ANr.	Beschreibung	AGr.	Einzelpreis
<b>Gutlehrdorne, LS, ohne ZM, Passung H7</b>				<b>Gutlehrdorne, LS, ohne ZM, andere Passungen</b>				<b>Gutlehrdorne, LS, mit ZM</b>			
8AB0240011	Z-GD-LS-H7-24	8AB	20,00 €	8AB0240014	Z-GD-LS-And-24	8AB	25,00 €	8AB0240012	Z-GD-LS-ZM-24	8AB	41,00 €
8AB0250011	Z-GD-LS-H7-25	8AB	22,00 €	8AB0250014	Z-GD-LS-And-25	8AB	25,00 €	8AB0250012	Z-GD-LS-ZM-25	8AB	43,00 €
8AB0260011	Z-GD-LS-H7-26	8AB	22,00 €	8AB0260014	Z-GD-LS-And-26	8AB	25,00 €	8AB0260012	Z-GD-LS-ZM-26	8AB	43,00 €
8AB0270011	Z-GD-LS-H7-27	8AB	22,00 €	8AB0270014	Z-GD-LS-And-27	8AB	26,00 €	8AB0270012	Z-GD-LS-ZM-27	8AB	44,00 €
8AB0280011	Z-GD-LS-H7-28	8AB	22,00 €	8AB0280014	Z-GD-LS-And-28	8AB	26,00 €	8AB0280012	Z-GD-LS-ZM-28	8AB	44,00 €
8AB0300011	Z-GD-LS-H7-30	8AB	22,00 €	8AB0300014	Z-GD-LS-And-30	8AB	27,00 €	8AB0300012	Z-GD-LS-ZM-30	8AB	47,00 €
8AB0320011	Z-GD-LS-H7-32	8AB	23,00 €	8AB0320014	Z-GD-LS-And-32	8AB	29,00 €	8AB0320012	Z-GD-LS-ZM-32	8AB	49,00 €
8AB0330011	Z-GD-LS-H7-33	8AB	23,00 €	8AB0330014	Z-GD-LS-And-33	8AB	30,00 €	8AB0330012	Z-GD-LS-ZM-33	8AB	50,00 €
8AB0340011	Z-GD-LS-H7-34	8AB	23,00 €	8AB0340014	Z-GD-LS-And-34	8AB	31,00 €	8AB0340012	Z-GD-LS-ZM-34	8AB	51,00 €
8AB0350011	Z-GD-LS-H7-35	8AB	28,00 €	8AB0350014	Z-GD-LS-And-35	8AB	31,00 €	8AB0350012	Z-GD-LS-ZM-35	8AB	52,00 €
8AB0360011	Z-GD-LS-H7-36	8AB	28,00 €	8AB0360014	Z-GD-LS-And-36	8AB	32,00 €	8AB0360012	Z-GD-LS-ZM-36	8AB	53,00 €
8AB0370011	Z-GD-LS-H7-37	8AB	28,00 €	8AB0370014	Z-GD-LS-And-37	8AB	32,00 €	8AB0370012	Z-GD-LS-ZM-37	8AB	55,00 €
8AB0380011	Z-GD-LS-H7-38	8AB	28,00 €	8AB0380014	Z-GD-LS-And-38	8AB	34,00 €	8AB0380012	Z-GD-LS-ZM-38	8AB	56,00 €
8AB0400011	Z-GD-LS-H7-40	8AB	29,00 €	8AB0400014	Z-GD-LS-And-40	8AB	34,00 €	8AB0400012	Z-GD-LS-ZM-40	8AB	58,00 €
8AB0420011	Z-GD-LS-H7-42	8AB	29,00 €	8AB0420014	Z-GD-LS-And-42	8AB	35,00 €	8AB0420012	Z-GD-LS-ZM-42	8AB	62,00 €
8AB0440011	Z-GD-LS-H7-44	8AB	29,00 €	8AB0440014	Z-GD-LS-And-44	8AB	38,00 €	8AB0440012	Z-GD-LS-ZM-44	8AB	64,00 €
8AB0450011	Z-GD-LS-H7-45	8AB	37,00 €	8AB0450014	Z-GD-LS-And-45	8AB	39,00 €	8AB0450012	Z-GD-LS-ZM-45	8AB	65,00 €
8AB0460011	Z-GD-LS-H7-46	8AB	37,00 €	8AB0460014	Z-GD-LS-And-46	8AB	40,00 €	8AB0460012	Z-GD-LS-ZM-46	8AB	67,00 €
8AB0470011	Z-GD-LS-H7-47	8AB	37,00 €	8AB0470014	Z-GD-LS-And-47	8AB	41,00 €	8AB0470012	Z-GD-LS-ZM-47	8AB	69,00 €
8AB0480011	Z-GD-LS-H7-48	8AB	37,00 €	8AB0480014	Z-GD-LS-And-48	8AB	42,00 €	8AB0480012	Z-GD-LS-ZM-48	8AB	71,00 €
8AB0500011	Z-GD-LS-H7-50	8AB	37,00 €	8AB0500014	Z-GD-LS-And-50	8AB	43,00 €	8AB0500012	Z-GD-LS-ZM-50	8AB	74,00 €
8AB0520011	Z-GD-LS-H7-52	8AB	40,00 €	8AB0520014	Z-GD-LS-And-52	8AB	45,00 €	8AB0520012	Z-GD-LS-ZM-52	8AB	77,00 €
8AB0550011	Z-GD-LS-H7-55	8AB	40,00 €	8AB0550014	Z-GD-LS-And-55	8AB	47,00 €	8AB0550012	Z-GD-LS-ZM-55	8AB	83,00 €
8AB0580011	Z-GD-LS-H7-58	8AB	40,00 €	8AB0580014	Z-GD-LS-And-58	8AB	50,00 €	8AB0580012	Z-GD-LS-ZM-58	8AB	86,00 €
8AB0600011	Z-GD-LS-H7-60	8AB	40,00 €	8AB0600014	Z-GD-LS-And-60	8AB	53,00 €	8AB0600012	Z-GD-LS-ZM-60	8AB	90,00 €
8AB0620011	Z-GD-LS-H7-62	8AB	47,00 €	8AB0620014	Z-GD-LS-And-62	8AB	55,00 €	8AB0620012	Z-GD-LS-ZM-62	8AB	92,00 €
8AB0650011	Z-GD-LS-H7-65	8AB	47,00 €	8AB0650014	Z-GD-LS-And-65	8AB	56,00 €	8AB0650012	Z-GD-LS-ZM-65	8AB	98,00 €
8AB0680011	Z-GD-LS-H7-68	8AB	49,00 €	8AB0680014	Z-GD-LS-And-68	8AB	60,00 €	8AB0680012	Z-GD-LS-ZM-68	8AB	100,00 €
8AB0700011	Z-GD-LS-H7-70	8AB	49,00 €	8AB0700014	Z-GD-LS-And-70	8AB	61,00 €	8AB0700012	Z-GD-LS-ZM-70	8AB	105,00 €
8AB0720011	Z-GD-LS-H7-72	8AB	57,00 €	8AB0720014	Z-GD-LS-And-72	8AB	64,00 €	8AB0720012	Z-GD-LS-ZM-72	8AB	109,00 €
8AB0750011	Z-GD-LS-H7-75	8AB	57,00 €	8AB0750014	Z-GD-LS-And-75	8AB	67,00 €	8AB0750012	Z-GD-LS-ZM-75	8AB	115,00 €
8AB0780011	Z-GD-LS-H7-78	8AB	59,00 €	8AB0780014	Z-GD-LS-And-78	8AB	70,00 €	8AB0780012	Z-GD-LS-ZM-78	8AB	116,00 €
8AB0800011	Z-GD-LS-H7-80	8AB	59,00 €	8AB0800014	Z-GD-LS-And-80	8AB	71,00 €	8AB0800012	Z-GD-LS-ZM-80	8AB	119,00 €
8AB0820011	Z-GD-LS-H7-82	8AB	63,00 €	8AB0820014	Z-GD-LS-And-82	8AB	73,00 €	8AB0820012	Z-GD-LS-ZM-82	8AB	123,00 €
8AB0850011	Z-GD-LS-H7-85	8AB	63,00 €	8AB0850014	Z-GD-LS-And-85	8AB	75,00 €	8AB0850012	Z-GD-LS-ZM-85	8AB	128,00 €
8AB0880011	Z-GD-LS-H7-88	8AB	65,00 €	8AB0880014	Z-GD-LS-And-88	8AB	78,00 €	8AB0880012	Z-GD-LS-ZM-88	8AB	132,00 €
8AB0900011	Z-GD-LS-H7-90	8AB	65,00 €	8AB0900014	Z-GD-LS-And-90	8AB	80,00 €	8AB0900012	Z-GD-LS-ZM-90	8AB	136,00 €
8AB0920011	Z-GD-LS-H7-92	8AB	71,00 €	8AB0920014	Z-GD-LS-And-92	8AB	83,00 €	8AB0920012	Z-GD-LS-ZM-92	8AB	139,00 €
8AB0950011	Z-GD-LS-H7-95	8AB	71,00 €	8AB0950014	Z-GD-LS-And-95	8AB	85,00 €	8AB0950012	Z-GD-LS-ZM-95	8AB	145,00 €
8AB0980011	Z-GD-LS-H7-98	8AB	74,00 €	8AB0980014	Z-GD-LS-And-98	8AB	88,00 €	8AB0980012	Z-GD-LS-ZM-98	8AB	148,00 €
8AB1000011	Z-GD-LS-H7-100	8AB	74,00 €	8AB1000014	Z-GD-LS-And-100	8AB	90,00 €	8AB1000012	Z-GD-LS-ZM-100	8AB	152,00 €

ANr.	Beschreibung	AGr.	Einzelpreis	ANr.	Beschreibung	AGr.	Einzelpreis	ANr.	Beschreibung	AGr.	Einzelpreis
------	--------------	------	-------------	------	--------------	------	-------------	------	--------------	------	-------------

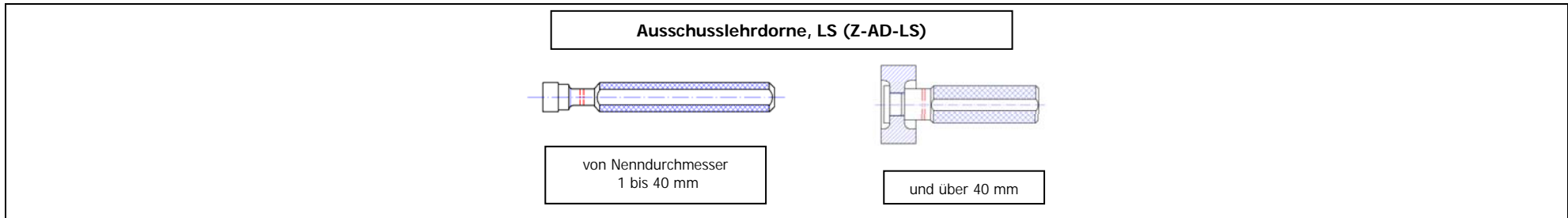

Ausschusslehrdorne, LS, ohne ZM, Passung H7				Ausschusslehrdorne, LS, ohne ZM, andere Passungen				Ausschusslehrdorne, LS, mit ZM			
8AC0010011	Z-AD-LS-H7-1	8AC	23,00 €	8AC0010014	Z-AD-LS-And-1	8AC	25,00 €	8AC0010012	Z-AD-LS-ZM-1	8AC	41,00 €
8AC0012011	Z-AD-LS-H7-1,2	8AC	21,00 €	8AC0012014	Z-AD-LS-And-1,2	8AC	23,00 €	8AC0012012	Z-AD-LS-ZM-1,2	8AC	41,00 €
8AC0015011	Z-AD-LS-H7-1,5	8AC	21,00 €	8AC0015014	Z-AD-LS-And-1,5	8AC	23,00 €	8AC0015012	Z-AD-LS-ZM-1,5	8AC	41,00 €
8AC0018011	Z-AD-LS-H7-1,8	8AC	21,00 €	8AC0018014	Z-AD-LS-And-1,8	8AC	23,00 €	8AC0018012	Z-AD-LS-ZM-1,8	8AC	41,00 €
8AC0020011	Z-AD-LS-H7-2	8AC	19,00 €	8AC0020014	Z-AD-LS-And-2	8AC	20,00 €	8AC0020012	Z-AD-LS-ZM-2	8AC	37,00 €
8AC0022011	Z-AD-LS-H7-2,2	8AC	19,00 €	8AC0022014	Z-AD-LS-And-2,2	8AC	20,00 €	8AC0022012	Z-AD-LS-ZM-2,2	8AC	37,00 €
8AC0025011	Z-AD-LS-H7-2,5	8AC	19,00 €	8AC0025014	Z-AD-LS-And-2,5	8AC	20,00 €	8AC0025012	Z-AD-LS-ZM-2,5	8AC	37,00 €
8AC0028011	Z-AD-LS-H7-2,8	8AC	16,00 €	8AC0028014	Z-AD-LS-And-2,8	8AC	17,00 €	8AC0028012	Z-AD-LS-ZM-2,8	8AC	33,00 €
8AC0030011	Z-AD-LS-H7-3	8AC	14,00 €	8AC0030014	Z-AD-LS-And-3	8AC	17,00 €	8AC0030012	Z-AD-LS-ZM-3	8AC	33,00 €
8AC0035011	Z-AD-LS-H7-3,5	8AC	14,00 €	8AC0035014	Z-AD-LS-And-3,5	8AC	16,00 €	8AC0035012	Z-AD-LS-ZM-3,5	8AC	28,00 €
8AC0040011	Z-AD-LS-H7-4	8AC	14,00 €	8AC0040014	Z-AD-LS-And-4	8AC	16,00 €	8AC0040012	Z-AD-LS-ZM-4	8AC	28,00 €
8AC0045011	Z-AD-LS-H7-4,5	8AC	14,00 €	8AC0045014	Z-AD-LS-And-4,5	8AC	16,00 €	8AC0045012	Z-AD-LS-ZM-4,5	8AC	28,00 €
8AC0050011	Z-AD-LS-H7-5	8AC	14,00 €	8AC0050014	Z-AD-LS-And-5	8AC	15,00 €	8AC0050012	Z-AD-LS-ZM-5	8AC	25,00 €
8AC0055011	Z-AD-LS-H7-5,5	8AC	14,00 €	8AC0055014	Z-AD-LS-And-5,5	8AC	15,00 €	8AC0055012	Z-AD-LS-ZM-5,5	8AC	25,00 €
8AC0060011	Z-AD-LS-H7-6	8AC	13,00 €	8AC0060014	Z-AD-LS-And-6	8AC	15,00 €	8AC0060012	Z-AD-LS-ZM-6	8AC	25,00 €
8AC0070011	Z-AD-LS-H7-7	8AC	13,00 €	8AC0070014	Z-AD-LS-And-7	8AC	15,00 €	8AC0070012	Z-AD-LS-ZM-7	8AC	26,00 €
8AC0080011	Z-AD-LS-H7-8	8AC	13,00 €	8AC0080014	Z-AD-LS-And-8	8AC	16,00 €	8AC0080012	Z-AD-LS-ZM-8	8AC	28,00 €
8AC0090011	Z-AD-LS-H7-9	8AC	13,00 €	8AC0090014	Z-AD-LS-And-9	8AC	16,00 €	8AC0090012	Z-AD-LS-ZM-9	8AC	28,00 €
8AC0100011	Z-AD-LS-H7-10	8AC	13,00 €	8AC0100014	Z-AD-LS-And-10	8AC	17,00 €	8AC0100012	Z-AD-LS-ZM-10	8AC	29,00 €
8AC0110011	Z-AD-LS-H7-11	8AC	13,00 €	8AC0110014	Z-AD-LS-And-11	8AC	17,00 €	8AC0110012	Z-AD-LS-ZM-11	8AC	29,00 €
8AC0120011	Z-AD-LS-H7-12	8AC	13,00 €	8AC0120014	Z-AD-LS-And-12	8AC	18,00 €	8AC0120012	Z-AD-LS-ZM-12	8AC	30,00 €
8AC0130011	Z-AD-LS-H7-13	8AC	14,00 €	8AC0130014	Z-AD-LS-And-13	8AC	19,00 €	8AC0130012	Z-AD-LS-ZM-13	8AC	31,00 €
8AC0140011	Z-AD-LS-H7-14	8AC	14,00 €	8AC0140014	Z-AD-LS-And-14	8AC	19,00 €	8AC0140012	Z-AD-LS-ZM-14	8AC	32,00 €
8AC0150011	Z-AD-LS-H7-15	8AC	14,00 €	8AC0150014	Z-AD-LS-And-15	8AC	20,00 €	8AC0150012	Z-AD-LS-ZM-15	8AC	33,00 €
8AC0160011	Z-AD-LS-H7-16	8AC	14,00 €	8AC0160014	Z-AD-LS-And-16	8AC	20,00 €	8AC0160012	Z-AD-LS-ZM-16	8AC	34,00 €
8AC0170011	Z-AD-LS-H7-17	8AC	19,00 €	8AC0170014	Z-AD-LS-And-17	8AC	20,00 €	8AC0170012	Z-AD-LS-ZM-17	8AC	35,00 €
8AC0180011	Z-AD-LS-H7-18	8AC	19,00 €	8AC0180014	Z-AD-LS-And-18	8AC	21,00 €	8AC0180012	Z-AD-LS-ZM-18	8AC	35,00 €
8AC0190011	Z-AD-LS-H7-19	8AC	19,00 €	8AC0190014	Z-AD-LS-And-19	8AC	22,00 €	8AC0190012	Z-AD-LS-ZM-19	8AC	37,00 €
8AC0200011	Z-AD-LS-H7-20	8AC	19,00 €	8AC0200014	Z-AD-LS-And-20	8AC	22,00 €	8AC0200012	Z-AD-LS-ZM-20	8AC	37,00 €
8AC0210011	Z-AD-LS-H7-21	8AC	20,00 €	8AC0210014	Z-AD-LS-And-21	8AC	23,00 €	8AC0210012	Z-AD-LS-ZM-21	8AC	38,00 €
8AC0220011	Z-AD-LS-H7-22	8AC	20,00 €	8AC0220014	Z-AD-LS-And-22	8AC	23,00 €	8AC0220012	Z-AD-LS-ZM-22	8AC	39,00 €
8AC0230011	Z-AD-LS-H7-23	8AC	20,00 €	8AC0230014	Z-AD-LS-And-23	8AC	24,00 €	8AC0230012	Z-AD-LS-ZM-23	8AC	40,00 €

ANr.	Beschreibung	AGr.	Einzelpreis	ANr.	Beschreibung	AGr.	Einzelpreis	ANr.	Beschreibung	AGr.	Einzelpreis
<b>Ausschusslehrdorne, LS, ohne ZM, Passung H7</b>				<b>Ausschusslehrdorne, LS, ohne ZM, andere Passungen</b>				<b>Ausschusslehrdorne, LS, mit ZM</b>			
8AC0240011	Z-AD-LS-H7-24	8AC	20,00 €	8AC0240014	Z-AD-LS-And-24	8AC	25,00 €	8AC0240012	Z-AD-LS-ZM-24	8AC	41,00 €
8AC0250011	Z-AD-LS-H7-25	8AC	22,00 €	8AC0250014	Z-AD-LS-And-25	8AC	25,00 €	8AC0250012	Z-AD-LS-ZM-25	8AC	43,00 €
8AC0260011	Z-AD-LS-H7-26	8AC	22,00 €	8AC0260014	Z-AD-LS-And-26	8AC	25,00 €	8AC0260012	Z-AD-LS-ZM-26	8AC	43,00 €
8AC0270011	Z-AD-LS-H7-27	8AC	22,00 €	8AC0270014	Z-AD-LS-And-27	8AC	26,00 €	8AC0270012	Z-AD-LS-ZM-27	8AC	44,00 €
8AC0280011	Z-AD-LS-H7-28	8AC	22,00 €	8AC0280014	Z-AD-LS-And-28	8AC	26,00 €	8AC0280012	Z-AD-LS-ZM-28	8AC	44,00 €
8AC0300011	Z-AD-LS-H7-30	8AC	22,00 €	8AC0300014	Z-AD-LS-And-30	8AC	27,00 €	8AC0300012	Z-AD-LS-ZM-30	8AC	47,00 €
8AC0320011	Z-AD-LS-H7-32	8AC	23,00 €	8AC0320014	Z-AD-LS-And-32	8AC	29,00 €	8AC0320012	Z-AD-LS-ZM-32	8AC	49,00 €
8AC0330011	Z-AD-LS-H7-33	8AC	23,00 €	8AC0330014	Z-AD-LS-And-33	8AC	30,00 €	8AC0330012	Z-AD-LS-ZM-33	8AC	50,00 €
8AC0340011	Z-AD-LS-H7-34	8AC	23,00 €	8AC0340014	Z-AD-LS-And-34	8AC	31,00 €	8AC0340012	Z-AD-LS-ZM-34	8AC	51,00 €
8AC0350011	Z-AD-LS-H7-35	8AC	28,00 €	8AC0350014	Z-AD-LS-And-35	8AC	31,00 €	8AC0350012	Z-AD-LS-ZM-35	8AC	52,00 €
8AC0360011	Z-AD-LS-H7-36	8AC	28,00 €	8AC0360014	Z-AD-LS-And-36	8AC	32,00 €	8AC0360012	Z-AD-LS-ZM-36	8AC	53,00 €
8AC0370011	Z-AD-LS-H7-37	8AC	28,00 €	8AC0370014	Z-AD-LS-And-37	8AC	32,00 €	8AC0370012	Z-AD-LS-ZM-37	8AC	55,00 €
8AC0380011	Z-AD-LS-H7-38	8AC	28,00 €	8AC0380014	Z-AD-LS-And-38	8AC	34,00 €	8AC0380012	Z-AD-LS-ZM-38	8AC	56,00 €
8AC0400011	Z-AD-LS-H7-40	8AC	29,00 €	8AC0400014	Z-AD-LS-And-40	8AC	34,00 €	8AC0400012	Z-AD-LS-ZM-40	8AC	58,00 €
8AC0420011	Z-AD-LS-H7-42	8AC	29,00 €	8AC0420014	Z-AD-LS-And-42	8AC	35,00 €	8AC0420012	Z-AD-LS-ZM-42	8AC	62,00 €
8AC0440011	Z-AD-LS-H7-44	8AC	29,00 €	8AC0440014	Z-AD-LS-And-44	8AC	38,00 €	8AC0440012	Z-AD-LS-ZM-44	8AC	64,00 €
8AC0450011	Z-AD-LS-H7-45	8AC	37,00 €	8AC0450014	Z-AD-LS-And-45	8AC	39,00 €	8AC0450012	Z-AD-LS-ZM-45	8AC	65,00 €
8AC0460011	Z-AD-LS-H7-46	8AC	37,00 €	8AC0460014	Z-AD-LS-And-46	8AC	40,00 €	8AC0460012	Z-AD-LS-ZM-46	8AC	67,00 €
8AC0470011	Z-AD-LS-H7-47	8AC	37,00 €	8AC0470014	Z-AD-LS-And-47	8AC	41,00 €	8AC0470012	Z-AD-LS-ZM-47	8AC	69,00 €
8AC0480011	Z-AD-LS-H7-48	8AC	37,00 €	8AC0480014	Z-AD-LS-And-48	8AC	42,00 €	8AC0480012	Z-AD-LS-ZM-48	8AC	71,00 €
8AC0500011	Z-AD-LS-H7-50	8AC	37,00 €	8AC0500014	Z-AD-LS-And-50	8AC	43,00 €	8AC0500012	Z-AD-LS-ZM-50	8AC	74,00 €
8AC0520011	Z-AD-LS-H7-52	8AC	40,00 €	8AC0520014	Z-AD-LS-And-52	8AC	45,00 €	8AC0520012	Z-AD-LS-ZM-52	8AC	77,00 €
8AC0550011	Z-AD-LS-H7-55	8AC	40,00 €	8AC0550014	Z-AD-LS-And-55	8AC	47,00 €	8AC0550012	Z-AD-LS-ZM-55	8AC	83,00 €
8AC0580011	Z-AD-LS-H7-58	8AC	40,00 €	8AC0580014	Z-AD-LS-And-58	8AC	50,00 €	8AC0580012	Z-AD-LS-ZM-58	8AC	86,00 €
8AC0600011	Z-AD-LS-H7-60	8AC	40,00 €	8AC0600014	Z-AD-LS-And-60	8AC	53,00 €	8AC0600012	Z-AD-LS-ZM-60	8AC	90,00 €
8AC0620011	Z-AD-LS-H7-62	8AC	47,00 €	8AC0620014	Z-AD-LS-And-62	8AC	55,00 €	8AC0620012	Z-AD-LS-ZM-62	8AC	92,00 €
8AC0650011	Z-AD-LS-H7-65	8AC	47,00 €	8AC0650014	Z-AD-LS-And-65	8AC	56,00 €	8AC0650012	Z-AD-LS-ZM-65	8AC	98,00 €
8AC0680011	Z-AD-LS-H7-68	8AC	49,00 €	8AC0680014	Z-AD-LS-And-68	8AC	60,00 €	8AC0680012	Z-AD-LS-ZM-68	8AC	100,00 €
8AC0700011	Z-AD-LS-H7-70	8AC	49,00 €	8AC0700014	Z-AD-LS-And-70	8AC	61,00 €	8AC0700012	Z-AD-LS-ZM-70	8AC	105,00 €
8AC0720011	Z-AD-LS-H7-72	8AC	57,00 €	8AC0720014	Z-AD-LS-And-72	8AC	64,00 €	8AC0720012	Z-AD-LS-ZM-72	8AC	109,00 €
8AC0750011	Z-AD-LS-H7-75	8AC	57,00 €	8AC0750014	Z-AD-LS-And-75	8AC	67,00 €	8AC0750012	Z-AD-LS-ZM-75	8AC	115,00 €
8AC0780011	Z-AD-LS-H7-78	8AC	59,00 €	8AC0780014	Z-AD-LS-And-78	8AC	70,00 €	8AC0780012	Z-AD-LS-ZM-78	8AC	116,00 €
8AC0800011	Z-AD-LS-H7-80	8AC	59,00 €	8AC0800014	Z-AD-LS-And-80	8AC	71,00 €	8AC0800012	Z-AD-LS-ZM-80	8AC	119,00 €
8AC0820011	Z-AD-LS-H7-82	8AC	63,00 €	8AC0820014	Z-AD-LS-And-82	8AC	73,00 €	8AC0820012	Z-AD-LS-ZM-82	8AC	123,00 €
8AC0850011	Z-AD-LS-H7-85	8AC	63,00 €	8AC0850014	Z-AD-LS-And-85	8AC	75,00 €	8AC0850012	Z-AD-LS-ZM-85	8AC	128,00 €
8AC0880011	Z-AD-LS-H7-88	8AC	65,00 €	8AC0880014	Z-AD-LS-And-88	8AC	78,00 €	8AC0880012	Z-AD-LS-ZM-88	8AC	132,00 €
8AC0900011	Z-AD-LS-H7-90	8AC	65,00 €	8AC0900014	Z-AD-LS-And-90	8AC	80,00 €	8AC0900012	Z-AD-LS-ZM-90	8AC	136,00 €
8AC0920011	Z-AD-LS-H7-92	8AC	71,00 €	8AC0920014	Z-AD-LS-And-92	8AC	83,00 €	8AC0920012	Z-AD-LS-ZM-92	8AC	139,00 €
8AC0950011	Z-AD-LS-H7-95	8AC	71,00 €	8AC0950014	Z-AD-LS-And-95	8AC	85,00 €	8AC0950012	Z-AD-LS-ZM-95	8AC	145,00 €
8AC0980011	Z-AD-LS-H7-98	8AC	74,00 €	8AC0980014	Z-AD-LS-And-98	8AC	88,00 €	8AC0980012	Z-AD-LS-ZM-98	8AC	148,00 €
8AC1000011	Z-AD-LS-H7-100	8AC	74,00 €	8AC1000014	Z-AD-LS-And-100	8AC	90,00 €	8AC1000012	Z-AD-LS-ZM-100	8AC	152,00 €



Anr.	Beschreibung	AGr.	Einzelpreis	Anr.	Beschreibung	AGr.	Einzelpreis	Anr.	Beschreibung	AGr.	Einzelpreis
------	--------------	------	-------------	------	--------------	------	-------------	------	--------------	------	-------------

Grenzlehrdorne, GHC (Z-GLD-GHC) / HC (Z-GLD-HC)



von Nenndurchmesser 1 bis 100 mm

Grenzlehrdorne, GHC, ohne ZM, Passung H7				Grenzlehrdorne, GHC, ohne ZM, andere Passungen				Grenzlehrdorne, GHC, mit ZM			
8AA0010021	Z-GLD-GHC-H7-1	8AA	57,00 €	8AA0010024	Z-GLD-GHC-And-1	8AA	62,00 €	8AA0010022	Z-GLD-GHC-ZM-1	8AA	102,00 €
8AA0012021	Z-GLD-GHC-H7-1,2	8AA	53,00 €	8AA0012024	Z-GLD-GHC-And-1,2	8AA	57,00 €	8AA0012022	Z-GLD-GHC-ZM-1,2	8AA	102,00 €
8AA0015021	Z-GLD-GHC-H7-1,5	8AA	53,00 €	8AA0015024	Z-GLD-GHC-And-1,5	8AA	57,00 €	8AA0015022	Z-GLD-GHC-ZM-1,5	8AA	102,00 €
8AA0018021	Z-GLD-GHC-H7-1,8	8AA	53,00 €	8AA0018024	Z-GLD-GHC-And-1,8	8AA	57,00 €	8AA0018022	Z-GLD-GHC-ZM-1,8	8AA	102,00 €
8AA0020021	Z-GLD-GHC-H7-2	8AA	46,00 €	8AA0020024	Z-GLD-GHC-And-2	8AA	50,00 €	8AA0020022	Z-GLD-GHC-ZM-2	8AA	93,00 €
8AA0022021	Z-GLD-GHC-H7-2,2	8AA	46,00 €	8AA0022024	Z-GLD-GHC-And-2,2	8AA	50,00 €	8AA0022022	Z-GLD-GHC-ZM-2,2	8AA	93,00 €
8AA0025021	Z-GLD-GHC-H7-2,5	8AA	46,00 €	8AA0025024	Z-GLD-GHC-And-2,5	8AA	50,00 €	8AA0025022	Z-GLD-GHC-ZM-2,5	8AA	93,00 €
8AA0028021	Z-GLD-GHC-H7-2,8	8AA	40,00 €	8AA0028024	Z-GLD-GHC-And-2,8	8AA	43,00 €	8AA0028022	Z-GLD-GHC-ZM-2,8	8AA	82,00 €
8AA0030021	Z-GLD-GHC-H7-3	8AA	40,00 €	8AA0030024	Z-GLD-GHC-And-3	8AA	43,00 €	8AA0030022	Z-GLD-GHC-ZM-3	8AA	82,00 €
8AA0035021	Z-GLD-GHC-H7-3,5	8AA	36,00 €	8AA0035024	Z-GLD-GHC-And-3,5	8AA	39,00 €	8AA0035022	Z-GLD-GHC-ZM-3,5	8AA	71,00 €
8AA0040021	Z-GLD-GHC-H7-4	8AA	36,00 €	8AA0040024	Z-GLD-GHC-And-4	8AA	39,00 €	8AA0040022	Z-GLD-GHC-ZM-4	8AA	71,00 €
8AA0045021	Z-GLD-GHC-H7-4,5	8AA	36,00 €	8AA0045024	Z-GLD-GHC-And-4,5	8AA	39,00 €	8AA0045022	Z-GLD-GHC-ZM-4,5	8AA	71,00 €
8AA0050021	Z-GLD-GHC-H7-5	8AA	34,00 €	8AA0050024	Z-GLD-GHC-And-5	8AA	37,00 €	8AA0050022	Z-GLD-GHC-ZM-5	8AA	64,00 €
8AA0055021	Z-GLD-GHC-H7-5,5	8AA	34,00 €	8AA0055024	Z-GLD-GHC-And-5,5	8AA	37,00 €	8AA0055022	Z-GLD-GHC-ZM-5,5	8AA	64,00 €
8AA0060021	Z-GLD-GHC-H7-6	8AA	34,00 €	8AA0060024	Z-GLD-GHC-And-6	8AA	37,00 €	8AA0060022	Z-GLD-GHC-ZM-6	8AA	64,00 €
8AA0070021	Z-GLD-GHC-H7-7	8AA	35,00 €	8AA0070024	Z-GLD-GHC-And-7	8AA	38,00 €	8AA0070022	Z-GLD-GHC-ZM-7	8AA	64,00 €
8AA0080021	Z-GLD-GHC-H7-8	8AA	36,00 €	8AA0080024	Z-GLD-GHC-And-8	8AA	39,00 €	8AA0080022	Z-GLD-GHC-ZM-8	8AA	66,00 €
8AA0090021	Z-GLD-GHC-H7-9	8AA	38,00 €	8AA0090024	Z-GLD-GHC-And-9	8AA	41,00 €	8AA0090022	Z-GLD-GHC-ZM-9	8AA	69,00 €
8AA0100021	Z-GLD-GHC-H7-10	8AA	39,00 €	8AA0100024	Z-GLD-GHC-And-10	8AA	42,00 €	8AA0100022	Z-GLD-GHC-ZM-10	8AA	71,00 €
8AA0110021	Z-GLD-GHC-H7-11	8AA	40,00 €	8AA0110024	Z-GLD-GHC-And-11	8AA	43,00 €	8AA0110022	Z-GLD-GHC-ZM-11	8AA	73,00 €
8AA0120021	Z-GLD-GHC-H7-12	8AA	41,00 €	8AA0120024	Z-GLD-GHC-And-12	8AA	45,00 €	8AA0120022	Z-GLD-GHC-ZM-12	8AA	75,00 €
8AA0130021	Z-GLD-GHC-H7-13	8AA	43,00 €	8AA0130024	Z-GLD-GHC-And-13	8AA	46,00 €	8AA0130022	Z-GLD-GHC-ZM-13	8AA	77,00 €
8AA0140021	Z-GLD-GHC-H7-14	8AA	44,00 €	8AA0140024	Z-GLD-GHC-And-14	8AA	47,00 €	8AA0140022	Z-GLD-GHC-ZM-14	8AA	79,00 €
8AA0150021	Z-GLD-GHC-H7-15	8AA	45,00 €	8AA0150024	Z-GLD-GHC-And-15	8AA	49,00 €	8AA0150022	Z-GLD-GHC-ZM-15	8AA	82,00 €
8AA0160021	Z-GLD-GHC-H7-16	8AA	46,00 €	8AA0160024	Z-GLD-GHC-And-16	8AA	50,00 €	8AA0160022	Z-GLD-GHC-ZM-16	8AA	84,00 €
8AA0170021	Z-GLD-GHC-H7-17	8AA	47,00 €	8AA0170024	Z-GLD-GHC-And-17	8AA	51,00 €	8AA0170022	Z-GLD-GHC-ZM-17	8AA	86,00 €
8AA0180021	Z-GLD-GHC-H7-18	8AA	49,00 €	8AA0180024	Z-GLD-GHC-And-18	8AA	53,00 €	8AA0180022	Z-GLD-GHC-ZM-18	8AA	89,00 €
8AA0190021	Z-GLD-GHC-H7-19	8AA	50,00 €	8AA0190024	Z-GLD-GHC-And-19	8AA	54,00 €	8AA0190022	Z-GLD-GHC-ZM-19	8AA	93,00 €
8AA0200021	Z-GLD-GHC-H7-20	8AA	50,00 €	8AA0200024	Z-GLD-GHC-And-20	8AA	54,00 €	8AA0200022	Z-GLD-GHC-ZM-20	8AA	93,00 €
8AA0210021	Z-GLD-GHC-H7-21	8AA	53,00 €	8AA0210024	Z-GLD-GHC-And-21	8AA	57,00 €	8AA0210022	Z-GLD-GHC-ZM-21	8AA	95,00 €
8AA0220021	Z-GLD-GHC-H7-22	8AA	54,00 €	8AA0220024	Z-GLD-GHC-And-22	8AA	58,00 €	8AA0220022	Z-GLD-GHC-ZM-22	8AA	97,00 €
8AA0230021	Z-GLD-GHC-H7-23	8AA	55,00 €	8AA0230024	Z-GLD-GHC-And-23	8AA	59,00 €	8AA0230022	Z-GLD-GHC-ZM-23	8AA	99,00 €
8AA0240021	Z-GLD-GHC-H7-24	8AA	56,00 €	8AA0240024	Z-GLD-GHC-And-24	8AA	61,00 €	8AA0240022	Z-GLD-GHC-ZM-24	8AA	102,00 €
8AA0250021	Z-GLD-GHC-H7-25	8AA	57,00 €	8AA0250024	Z-GLD-GHC-And-25	8AA	62,00 €	8AA0250022	Z-GLD-GHC-ZM-25	8AA	104,00 €



ANr.	Beschreibung	AGr.	Einzelpreis	ANr.	Beschreibung	AGr.	Einzelpreis	ANr.	Beschreibung	AGr.	Einzelpreis
<b>Grenzlehrdorne, GHC, ohne ZM, Passung H7</b>				<b>Grenzlehrdorne, GHC, ohne ZM, andere Passungen</b>				<b>Grenzlehrdorne, GHC, mit ZM</b>			
8AA0260021	Z-GLD-GHC-H7-26	8AA	58,00 €	8AA0260024	Z-GLD-GHC-And-26	8AA	63,00 €	8AA0260022	Z-GLD-GHC-ZM-26	8AA	106,00 €
8AA0270021	Z-GLD-GHC-H7-27	8AA	60,00 €	8AA0270024	Z-GLD-GHC-And-27	8AA	65,00 €	8AA0270022	Z-GLD-GHC-ZM-27	8AA	108,00 €
8AA0280021	Z-GLD-GHC-H7-28	8AA	61,00 €	8AA0280024	Z-GLD-GHC-And-28	8AA	66,00 €	8AA0280022	Z-GLD-GHC-ZM-28	8AA	110,00 €
8AA0300021	Z-GLD-GHC-H7-30	8AA	62,00 €	8AA0300024	Z-GLD-GHC-And-30	8AA	67,00 €	8AA0300022	Z-GLD-GHC-ZM-30	8AA	119,00 €
8AA0320021	Z-GLD-GHC-H7-32	8AA	67,00 €	8AA0320024	Z-GLD-GHC-And-32	8AA	73,00 €	8AA0320022	Z-GLD-GHC-ZM-32	8AA	123,00 €
8AA0330021	Z-GLD-GHC-H7-33	8AA	70,00 €	8AA0330024	Z-GLD-GHC-And-33	8AA	75,00 €	8AA0330022	Z-GLD-GHC-ZM-33	8AA	126,00 €
8AA0340021	Z-GLD-GHC-H7-34	8AA	71,00 €	8AA0340024	Z-GLD-GHC-And-34	8AA	77,00 €	8AA0340022	Z-GLD-GHC-ZM-34	8AA	128,00 €
8AA0350021	Z-GLD-GHC-H7-35	8AA	72,00 €	8AA0350024	Z-GLD-GHC-And-35	8AA	78,00 €	8AA0350022	Z-GLD-GHC-ZM-35	8AA	130,00 €
8AA0360021	Z-GLD-GHC-H7-36	8AA	73,00 €	8AA0360024	Z-GLD-GHC-And-36	8AA	79,00 €	8AA0360022	Z-GLD-GHC-ZM-36	8AA	132,00 €
8AA0370021	Z-GLD-GHC-H7-37	8AA	75,00 €	8AA0370024	Z-GLD-GHC-And-37	8AA	81,00 €	8AA0370022	Z-GLD-GHC-ZM-37	8AA	137,00 €
8AA0380021	Z-GLD-GHC-H7-38	8AA	77,00 €	8AA0380024	Z-GLD-GHC-And-38	8AA	83,00 €	8AA0380022	Z-GLD-GHC-ZM-38	8AA	141,00 €
8AA0400021	Z-GLD-GHC-H7-40	8AA	80,00 €	8AA0400024	Z-GLD-GHC-And-40	8AA	86,00 €	8AA0400022	Z-GLD-GHC-ZM-40	8AA	146,00 €
8AA0420021	Z-GLD-GHC-H7-42	8AA	82,00 €	8AA0420024	Z-GLD-GHC-And-42	8AA	89,00 €	8AA0420022	Z-GLD-GHC-ZM-42	8AA	154,00 €
8AA0440021	Z-GLD-GHC-H7-44	8AA	87,00 €	8AA0440024	Z-GLD-GHC-And-44	8AA	94,00 €	8AA0440022	Z-GLD-GHC-ZM-44	8AA	158,00 €
8AA0450021	Z-GLD-GHC-H7-45	8AA	89,00 €	8AA0450024	Z-GLD-GHC-And-45	8AA	97,00 €	8AA0450022	Z-GLD-GHC-ZM-45	8AA	163,00 €
8AA0460021	Z-GLD-GHC-H7-46	8AA	92,00 €	8AA0460024	Z-GLD-GHC-And-46	8AA	99,00 €	8AA0460022	Z-GLD-GHC-ZM-46	8AA	168,00 €
8AA0470021	Z-GLD-GHC-H7-47	8AA	95,00 €	8AA0470024	Z-GLD-GHC-And-47	8AA	102,00 €	8AA0470022	Z-GLD-GHC-ZM-47	8AA	172,00 €
8AA0480021	Z-GLD-GHC-H7-48	8AA	97,00 €	8AA0480024	Z-GLD-GHC-And-48	8AA	105,00 €	8AA0480022	Z-GLD-GHC-ZM-48	8AA	176,00 €
8AA0500021	Z-GLD-GHC-H7-50	8AA	99,00 €	8AA0500024	Z-GLD-GHC-And-50	8AA	107,00 €	8AA0500022	Z-GLD-GHC-ZM-50	8AA	185,00 €
8AA0520021	Z-GLD-GHC-H7-52	8AA	104,00 €	8AA0520024	Z-GLD-GHC-And-52	8AA	113,00 €	8AA0520022	Z-GLD-GHC-ZM-52	8AA	194,00 €
8AA0550021	Z-GLD-GHC-H7-55	8AA	109,00 €	8AA0550024	Z-GLD-GHC-And-55	8AA	118,00 €	8AA0550022	Z-GLD-GHC-ZM-55	8AA	207,00 €
8AA0580021	Z-GLD-GHC-H7-58	8AA	117,00 €	8AA0580024	Z-GLD-GHC-And-58	8AA	126,00 €	8AA0580022	Z-GLD-GHC-ZM-58	8AA	216,00 €
8AA0600021	Z-GLD-GHC-H7-60	8AA	122,00 €	8AA0600024	Z-GLD-GHC-And-60	8AA	131,00 €	8AA0600022	Z-GLD-GHC-ZM-60	8AA	225,00 €
8AA0620021	Z-GLD-GHC-H7-62	8AA	127,00 €	8AA0620024	Z-GLD-GHC-And-62	8AA	137,00 €	8AA0620022	Z-GLD-GHC-ZM-62	8AA	231,00 €
8AA0650021	Z-GLD-GHC-H7-65	8AA	130,00 €	8AA0650024	Z-GLD-GHC-And-65	8AA	141,00 €	8AA0650022	Z-GLD-GHC-ZM-65	8AA	247,00 €
8AA0680021	Z-GLD-GHC-H7-68	8AA	139,00 €	8AA0680024	Z-GLD-GHC-And-68	8AA	150,00 €	8AA0680022	Z-GLD-GHC-ZM-68	8AA	251,00 €
8AA0700021	Z-GLD-GHC-H7-70	8AA	141,00 €	8AA0700024	Z-GLD-GHC-And-70	8AA	153,00 €	8AA0700022	Z-GLD-GHC-ZM-70	8AA	262,00 €
8AA0720021	Z-GLD-GHC-H7-72	8AA	147,00 €	8AA0720024	Z-GLD-GHC-And-72	8AA	159,00 €	8AA0720022	Z-GLD-GHC-ZM-72	8AA	273,00 €
8AA0750021	Z-GLD-GHC-H7-75	8AA	154,00 €	8AA0750024	Z-GLD-GHC-And-75	8AA	166,00 €	8AA0750022	Z-GLD-GHC-ZM-75	8AA	286,00 €
8AA0780021	Z-GLD-GHC-H7-78	8AA	161,00 €	8AA0780024	Z-GLD-GHC-And-78	8AA	174,00 €	8AA0780022	Z-GLD-GHC-ZM-78	8AA	290,00 €
8AA0800021	Z-GLD-GHC-H7-80	8AA	164,00 €	8AA0800024	Z-GLD-GHC-And-80	8AA	177,00 €	8AA0800022	Z-GLD-GHC-ZM-80	8AA	299,00 €
8AA0820021	Z-GLD-GHC-H7-82	8AA	168,00 €	8AA0820024	Z-GLD-GHC-And-82	8AA	182,00 €	8AA0820022	Z-GLD-GHC-ZM-82	8AA	308,00 €
8AA0850021	Z-GLD-GHC-H7-85	8AA	173,00 €	8AA0850024	Z-GLD-GHC-And-85	8AA	188,00 €	8AA0850022	Z-GLD-GHC-ZM-85	8AA	321,00 €
8AA0880021	Z-GLD-GHC-H7-88	8AA	181,00 €	8AA0880024	Z-GLD-GHC-And-88	8AA	195,00 €	8AA0880022	Z-GLD-GHC-ZM-88	8AA	330,00 €
8AA0900021	Z-GLD-GHC-H7-90	8AA	186,00 €	8AA0900024	Z-GLD-GHC-And-90	8AA	201,00 €	8AA0900022	Z-GLD-GHC-ZM-90	8AA	338,00 €
8AA0920021	Z-GLD-GHC-H7-92	8AA	191,00 €	8AA0920024	Z-GLD-GHC-And-92	8AA	206,00 €	8AA0920022	Z-GLD-GHC-ZM-92	8AA	347,00 €
8AA0950021	Z-GLD-GHC-H7-95	8AA	196,00 €	8AA0950024	Z-GLD-GHC-And-95	8AA	212,00 €	8AA0950022	Z-GLD-GHC-ZM-95	8AA	361,00 €
8AA0980021	Z-GLD-GHC-H7-98	8AA	203,00 €	8AA0980024	Z-GLD-GHC-And-98	8AA	220,00 €	8AA0980022	Z-GLD-GHC-ZM-98	8AA	369,00 €
8AA1000021	Z-GLD-GHC-H7-100	8AA	208,00 €	8AA1000024	Z-GLD-GHC-And-100	8AA	225,00 €	8AA1000022	Z-GLD-GHC-ZM-100	8AA	374,00 €

ANr.	Beschreibung	AGr.	Einzelpreis	ANr.	Beschreibung	AGr.	Einzelpreis	ANr.	Beschreibung	AGr.	Einzelpreis
<b>Grenzlehrdorne, HC, ohne ZM, Passung H7</b>				<b>Grenzlehrdorne, HC, ohne ZM, andere Passungen</b>				<b>Grenzlehrdorne, HC, mit ZM</b>			
8AA0010031	Z-GLD-HC-H7-1	8AA	76,00 €	8AA0010034	Z-GLD-HC-And-1	8AA	82,00 €	8AA0010032	Z-GLD-HC-ZM-1	8AA	135,00 €
8AA0012031	Z-GLD-HC-H7-1,2	8AA	70,00 €	8AA0012034	Z-GLD-HC-And-1,2	8AA	75,00 €	8AA0012032	Z-GLD-HC-ZM-1,2	8AA	135,00 €
8AA0015031	Z-GLD-HC-H7-1,5	8AA	70,00 €	8AA0015034	Z-GLD-HC-And-1,5	8AA	75,00 €	8AA0015032	Z-GLD-HC-ZM-1,5	8AA	135,00 €
8AA0018031	Z-GLD-HC-H7-1,8	8AA	70,00 €	8AA0018034	Z-GLD-HC-And-1,8	8AA	75,00 €	8AA0018032	Z-GLD-HC-ZM-1,8	8AA	135,00 €
8AA0020031	Z-GLD-HC-H7-2	8AA	61,00 €	8AA0020034	Z-GLD-HC-And-2	8AA	66,00 €	8AA0020032	Z-GLD-HC-ZM-2	8AA	124,00 €
8AA0022031	Z-GLD-HC-H7-2,2	8AA	61,00 €	8AA0022034	Z-GLD-HC-And-2,2	8AA	66,00 €	8AA0022032	Z-GLD-HC-ZM-2,2	8AA	124,00 €
8AA0025031	Z-GLD-HC-H7-2,5	8AA	61,00 €	8AA0025034	Z-GLD-HC-And-2,5	8AA	66,00 €	8AA0025032	Z-GLD-HC-ZM-2,5	8AA	124,00 €
8AA0028031	Z-GLD-HC-H7-2,8	8AA	53,00 €	8AA0028034	Z-GLD-HC-And-2,8	8AA	57,00 €	8AA0028032	Z-GLD-HC-ZM-2,8	8AA	109,00 €
8AA0030031	Z-GLD-HC-H7-3	8AA	53,00 €	8AA0030034	Z-GLD-HC-And-3	8AA	58,00 €	8AA0030032	Z-GLD-HC-ZM-3	8AA	109,00 €
8AA0035031	Z-GLD-HC-H7-3,5	8AA	48,00 €	8AA0035034	Z-GLD-HC-And-3,5	8AA	57,00 €	8AA0035032	Z-GLD-HC-ZM-3,5	8AA	94,00 €
8AA0040031	Z-GLD-HC-H7-4	8AA	48,00 €	8AA0040034	Z-GLD-HC-And-4	8AA	52,00 €	8AA0040032	Z-GLD-HC-ZM-4	8AA	94,00 €
8AA0045031	Z-GLD-HC-H7-4,5	8AA	48,00 €	8AA0045034	Z-GLD-HC-And-4,5	8AA	52,00 €	8AA0045032	Z-GLD-HC-ZM-4,5	8AA	94,00 €
8AA0050031	Z-GLD-HC-H7-5	8AA	45,00 €	8AA0050034	Z-GLD-HC-And-5	8AA	52,00 €	8AA0050032	Z-GLD-HC-ZM-5	8AA	85,00 €
8AA0055031	Z-GLD-HC-H7-5,5	8AA	45,00 €	8AA0055034	Z-GLD-HC-And-5,5	8AA	49,00 €	8AA0055032	Z-GLD-HC-ZM-5,5	8AA	85,00 €
8AA0060031	Z-GLD-HC-H7-6	8AA	45,00 €	8AA0060034	Z-GLD-HC-And-6	8AA	49,00 €	8AA0060032	Z-GLD-HC-ZM-6	8AA	85,00 €
8AA0070031	Z-GLD-HC-H7-7	8AA	47,00 €	8AA0070034	Z-GLD-HC-And-7	8AA	50,00 €	8AA0070032	Z-GLD-HC-ZM-7	8AA	85,00 €
8AA0080031	Z-GLD-HC-H7-8	8AA	48,00 €	8AA0080034	Z-GLD-HC-And-8	8AA	52,00 €	8AA0080032	Z-GLD-HC-ZM-8	8AA	88,00 €
8AA0090031	Z-GLD-HC-H7-9	8AA	50,00 €	8AA0090034	Z-GLD-HC-And-9	8AA	54,00 €	8AA0090032	Z-GLD-HC-ZM-9	8AA	92,00 €
8AA0100031	Z-GLD-HC-H7-10	8AA	52,00 €	8AA0100034	Z-GLD-HC-And-10	8AA	56,00 €	8AA0100032	Z-GLD-HC-ZM-10	8AA	94,00 €
8AA0110031	Z-GLD-HC-H7-11	8AA	53,00 €	8AA0110034	Z-GLD-HC-And-11	8AA	57,00 €	8AA0110032	Z-GLD-HC-ZM-11	8AA	97,00 €
8AA0120031	Z-GLD-HC-H7-12	8AA	55,00 €	8AA0120034	Z-GLD-HC-And-12	8AA	59,00 €	8AA0120032	Z-GLD-HC-ZM-12	8AA	100,00 €
8AA0130031	Z-GLD-HC-H7-13	8AA	57,00 €	8AA0130034	Z-GLD-HC-And-13	8AA	61,00 €	8AA0130032	Z-GLD-HC-ZM-13	8AA	103,00 €
8AA0140031	Z-GLD-HC-H7-14	8AA	58,00 €	8AA0140034	Z-GLD-HC-And-14	8AA	63,00 €	8AA0140032	Z-GLD-HC-ZM-14	8AA	106,00 €
8AA0150031	Z-GLD-HC-H7-15	8AA	60,00 €	8AA0150034	Z-GLD-HC-And-15	8AA	65,00 €	8AA0150032	Z-GLD-HC-ZM-15	8AA	109,00 €
8AA0160031	Z-GLD-HC-H7-16	8AA	61,00 €	8AA0160034	Z-GLD-HC-And-16	8AA	66,00 €	8AA0160032	Z-GLD-HC-ZM-16	8AA	112,00 €
8AA0170031	Z-GLD-HC-H7-17	8AA	63,00 €	8AA0170034	Z-GLD-HC-And-17	8AA	68,00 €	8AA0170032	Z-GLD-HC-ZM-17	8AA	114,00 €
8AA0180031	Z-GLD-HC-H7-18	8AA	65,00 €	8AA0180034	Z-GLD-HC-And-18	8AA	70,00 €	8AA0180032	Z-GLD-HC-ZM-18	8AA	118,00 €
8AA0190031	Z-GLD-HC-H7-19	8AA	67,00 €	8AA0190034	Z-GLD-HC-And-19	8AA	72,00 €	8AA0190032	Z-GLD-HC-ZM-19	8AA	124,00 €
8AA0200031	Z-GLD-HC-H7-20	8AA	67,00 €	8AA0200034	Z-GLD-HC-And-20	8AA	72,00 €	8AA0200032	Z-GLD-HC-ZM-20	8AA	124,00 €
8AA0210031	Z-GLD-HC-H7-21	8AA	70,00 €	8AA0210034	Z-GLD-HC-And-21	8AA	75,00 €	8AA0210032	Z-GLD-HC-ZM-21	8AA	126,00 €
8AA0220031	Z-GLD-HC-H7-22	8AA	71,00 €	8AA0220034	Z-GLD-HC-And-22	8AA	77,00 €	8AA0220032	Z-GLD-HC-ZM-22	8AA	129,00 €
8AA0230031	Z-GLD-HC-H7-23	8AA	73,00 €	8AA0230034	Z-GLD-HC-And-23	8AA	79,00 €	8AA0230032	Z-GLD-HC-ZM-23	8AA	132,00 €
8AA0240031	Z-GLD-HC-H7-24	8AA	75,00 €	8AA0240034	Z-GLD-HC-And-24	8AA	81,00 €	8AA0240032	Z-GLD-HC-ZM-24	8AA	135,00 €
8AA0250031	Z-GLD-HC-H7-25	8AA	76,00 €	8AA0250034	Z-GLD-HC-And-25	8AA	82,00 €	8AA0250032	Z-GLD-HC-ZM-25	8AA	138,00 €
8AA0260031	Z-GLD-HC-H7-26	8AA	78,00 €	8AA0260034	Z-GLD-HC-And-26	8AA	84,00 €	8AA0260032	Z-GLD-HC-ZM-26	8AA	141,00 €
8AA0270031	Z-GLD-HC-H7-27	8AA	79,00 €	8AA0270034	Z-GLD-HC-And-27	8AA	86,00 €	8AA0270032	Z-GLD-HC-ZM-27	8AA	144,00 €
8AA0280031	Z-GLD-HC-H7-28	8AA	81,00 €	8AA0280034	Z-GLD-HC-And-28	8AA	88,00 €	8AA0280032	Z-GLD-HC-ZM-28	8AA	147,00 €
8AA0300031	Z-GLD-HC-H7-30	8AA	83,00 €	8AA0300034	Z-GLD-HC-And-30	8AA	89,00 €	8AA0300032	Z-GLD-HC-ZM-30	8AA	158,00 €
8AA0320031	Z-GLD-HC-H7-32	8AA	89,00 €	8AA0320034	Z-GLD-HC-And-32	8AA	97,00 €	8AA0320032	Z-GLD-HC-ZM-32	8AA	164,00 €
8AA0330031	Z-GLD-HC-H7-33	8AA	93,00 €	8AA0330034	Z-GLD-HC-And-33	8AA	100,00 €	8AA0330032	Z-GLD-HC-ZM-33	8AA	167,00 €
8AA0340031	Z-GLD-HC-H7-34	8AA	94,00 €	8AA0340034	Z-GLD-HC-And-34	8AA	102,00 €	8AA0340032	Z-GLD-HC-ZM-34	8AA	170,00 €
8AA0350031	Z-GLD-HC-H7-35	8AA	96,00 €	8AA0350034	Z-GLD-HC-And-35	8AA	104,00 €	8AA0350032	Z-GLD-HC-ZM-35	8AA	173,00 €
8AA0360031	Z-GLD-HC-H7-36	8AA	98,00 €	8AA0360034	Z-GLD-HC-And-36	8AA	106,00 €	8AA0360032	Z-GLD-HC-ZM-36	8AA	176,00 €
8AA0370031	Z-GLD-HC-H7-37	8AA	99,00 €	8AA0370034	Z-GLD-HC-And-37	8AA	107,00 €	8AA0370032	Z-GLD-HC-ZM-37	8AA	182,00 €

Anr.	Beschreibung	AGr.	Einzelpreis	Anr.	Beschreibung	AGr.	Einzelpreis	Anr.	Beschreibung	AGr.	Einzelpreis
<b>Grenzlehrdorne, HC, ohne ZM, Passung H7</b>				<b>Grenzlehrdorne, HC, ohne ZM, andere Passungen</b>				<b>Grenzlehrdorne, HC, mit ZM</b>			
8AA0380031	Z-GLD-HC-H7-38	8AA	103,00 €	8AA0380034	Z-GLD-HC-And-38	8AA	111,00 €	8AA0380032	Z-GLD-HC-ZM-38	8AA	188,00 €
8AA0400031	Z-GLD-HC-H7-40	8AA	106,00 €	8AA0400034	Z-GLD-HC-And-40	8AA	115,00 €	8AA0400032	Z-GLD-HC-ZM-40	8AA	194,00 €
8AA0420031	Z-GLD-HC-H7-42	8AA	109,00 €	8AA0420034	Z-GLD-HC-And-42	8AA	118,00 €	8AA0420032	Z-GLD-HC-ZM-42	8AA	205,00 €
8AA0440031	Z-GLD-HC-H7-44	8AA	116,00 €	8AA0440034	Z-GLD-HC-And-44	8AA	125,00 €	8AA0440032	Z-GLD-HC-ZM-44	8AA	211,00 €
8AA0450031	Z-GLD-HC-H7-45	8AA	119,00 €	8AA0450034	Z-GLD-HC-And-45	8AA	129,00 €	8AA0450032	Z-GLD-HC-ZM-45	8AA	217,00 €
8AA0460031	Z-GLD-HC-H7-46	8AA	122,00 €	8AA0460034	Z-GLD-HC-And-46	8AA	132,00 €	8AA0460032	Z-GLD-HC-ZM-46	8AA	223,00 €
8AA0470031	Z-GLD-HC-H7-47	8AA	126,00 €	8AA0470034	Z-GLD-HC-And-47	8AA	136,00 €	8AA0470032	Z-GLD-HC-ZM-47	8AA	229,00 €
8AA0480031	Z-GLD-HC-H7-48	8AA	129,00 €	8AA0480034	Z-GLD-HC-And-48	8AA	139,00 €	8AA0480032	Z-GLD-HC-ZM-48	8AA	235,00 €
8AA0500031	Z-GLD-HC-H7-50	8AA	132,00 €	8AA0500034	Z-GLD-HC-And-50	8AA	143,00 €	8AA0500032	Z-GLD-HC-ZM-50	8AA	246,00 €
8AA0520031	Z-GLD-HC-H7-52	8AA	139,00 €	8AA0520034	Z-GLD-HC-And-52	8AA	150,00 €	8AA0520032	Z-GLD-HC-ZM-52	8AA	258,00 €
8AA0550031	Z-GLD-HC-H7-55	8AA	145,00 €	8AA0550034	Z-GLD-HC-And-55	8AA	157,00 €	8AA0550032	Z-GLD-HC-ZM-55	8AA	276,00 €
8AA0580031	Z-GLD-HC-H7-58	8AA	155,00 €	8AA0580034	Z-GLD-HC-And-58	8AA	168,00 €	8AA0580032	Z-GLD-HC-ZM-58	8AA	287,00 €
8AA0600031	Z-GLD-HC-H7-60	8AA	162,00 €	8AA0600034	Z-GLD-HC-And-60	8AA	175,00 €	8AA0600032	Z-GLD-HC-ZM-60	8AA	299,00 €
8AA0620031	Z-GLD-HC-H7-62	8AA	169,00 €	8AA0620034	Z-GLD-HC-And-62	8AA	182,00 €	8AA0620032	Z-GLD-HC-ZM-62	8AA	308,00 €
8AA0650031	Z-GLD-HC-H7-65	8AA	173,00 €	8AA0650034	Z-GLD-HC-And-65	8AA	189,00 €	8AA0650032	Z-GLD-HC-ZM-65	8AA	328,00 €
8AA0680031	Z-GLD-HC-H7-68	8AA	185,00 €	8AA0680034	Z-GLD-HC-And-68	8AA	200,00 €	8AA0680032	Z-GLD-HC-ZM-68	8AA	334,00 €
8AA0700031	Z-GLD-HC-H7-70	8AA	188,00 €	8AA0700034	Z-GLD-HC-And-70	8AA	204,00 €	8AA0700032	Z-GLD-HC-ZM-70	8AA	349,00 €
8AA0720031	Z-GLD-HC-H7-72	8AA	196,00 €	8AA0720034	Z-GLD-HC-And-72	8AA	212,00 €	8AA0720032	Z-GLD-HC-ZM-72	8AA	363,00 €
8AA0750031	Z-GLD-HC-H7-75	8AA	205,00 €	8AA0750034	Z-GLD-HC-And-75	8AA	221,00 €	8AA0750032	Z-GLD-HC-ZM-75	8AA	381,00 €
8AA0780031	Z-GLD-HC-H7-78	8AA	215,00 €	8AA0780034	Z-GLD-HC-And-78	8AA	232,00 €	8AA0780032	Z-GLD-HC-ZM-78	8AA	387,00 €
8AA0800031	Z-GLD-HC-H7-80	8AA	218,00 €	8AA0800034	Z-GLD-HC-And-80	8AA	236,00 €	8AA0800032	Z-GLD-HC-ZM-80	8AA	398,00 €
8AA0820031	Z-GLD-HC-H7-82	8AA	224,00 €	8AA0820034	Z-GLD-HC-And-82	8AA	243,00 €	8AA0820032	Z-GLD-HC-ZM-82	8AA	410,00 €
8AA0850031	Z-GLD-HC-H7-85	8AA	231,00 €	8AA0850034	Z-GLD-HC-And-85	8AA	250,00 €	8AA0850032	Z-GLD-HC-ZM-85	8AA	427,00 €
8AA0880031	Z-GLD-HC-H7-88	8AA	241,00 €	8AA0880034	Z-GLD-HC-And-88	8AA	260,00 €	8AA0880032	Z-GLD-HC-ZM-88	8AA	440,00 €
8AA0900031	Z-GLD-HC-H7-90	8AA	247,00 €	8AA0900034	Z-GLD-HC-And-90	8AA	268,00 €	8AA0900032	Z-GLD-HC-ZM-90	8AA	451,00 €
8AA0920031	Z-GLD-HC-H7-92	8AA	254,00 €	8AA0920034	Z-GLD-HC-And-92	8AA	275,00 €	8AA0920032	Z-GLD-HC-ZM-92	8AA	463,00 €
8AA0950031	Z-GLD-HC-H7-95	8AA	261,00 €	8AA0950034	Z-GLD-HC-And-95	8AA	282,00 €	8AA0950032	Z-GLD-HC-ZM-95	8AA	481,00 €
8AA0980031	Z-GLD-HC-H7-98	8AA	271,00 €	8AA0980034	Z-GLD-HC-And-98	8AA	293,00 €	8AA0980032	Z-GLD-HC-ZM-98	8AA	492,00 €
8AA1000031	Z-GLD-HC-H7-100	8AA	277,00 €	8AA1000034	Z-GLD-HC-And-100	8AA	300,00 €	8AA1000032	Z-GLD-HC-ZM-100	8AA	504,00 €

ANr.	Beschreibung	AGr.	Einzelpreis	ANr.	Beschreibung	AGr.	Einzelpreis	ANr.	Beschreibung	AGr.	Einzelpreis
------	--------------	------	-------------	------	--------------	------	-------------	------	--------------	------	-------------

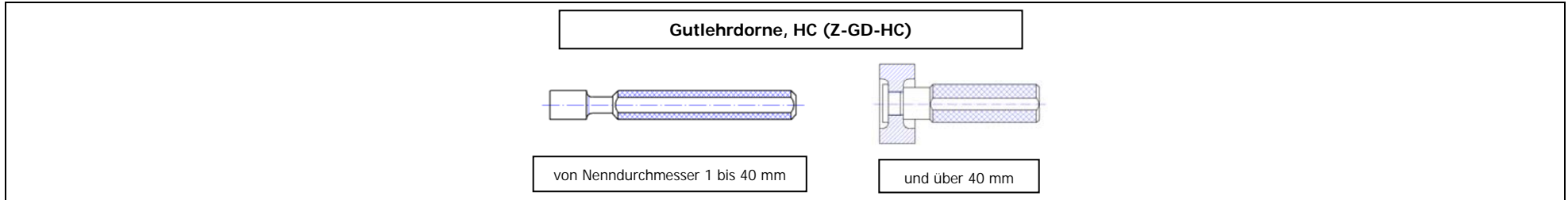

Gutlehdorne, HC, ohne ZM, Passung H7				Gutlehdorne, HC, ohne ZM, andere Passungen				Gutlehdorne, HC, mit ZM			
8AB0010031	Z-GD-HC-H7-1	8AB	46,00 €	8AB0010034	Z-GD-HC-And-1	8AB	49,00 €	8AB0010032	Z-GD-HC-ZM-1	8AB	81,00 €
8AB0012031	Z-GD-HC-H7-1,2	8AB	42,00 €	8AB0012034	Z-GD-HC-And-1,2	8AB	45,00 €	8AB0012032	Z-GD-HC-ZM-1,2	8AB	81,00 €
8AB0015031	Z-GD-HC-H7-1,5	8AB	42,00 €	8AB0015034	Z-GD-HC-And-1,5	8AB	45,00 €	8AB0015032	Z-GD-HC-ZM-1,5	8AB	81,00 €
8AB0018031	Z-GD-HC-H7-1,8	8AB	42,00 €	8AB0018034	Z-GD-HC-And-1,8	8AB	45,00 €	8AB0018032	Z-GD-HC-ZM-1,8	8AB	81,00 €
8AB0020031	Z-GD-HC-H7-2	8AB	37,00 €	8AB0020034	Z-GD-HC-And-2	8AB	40,00 €	8AB0020032	Z-GD-HC-ZM-2	8AB	74,00 €
8AB0022031	Z-GD-HC-H7-2,2	8AB	37,00 €	8AB0022034	Z-GD-HC-And-2,2	8AB	40,00 €	8AB0022032	Z-GD-HC-ZM-2,2	8AB	74,00 €
8AB0025031	Z-GD-HC-H7-2,5	8AB	37,00 €	8AB0025034	Z-GD-HC-And-2,5	8AB	40,00 €	8AB0025032	Z-GD-HC-ZM-2,5	8AB	74,00 €
8AB0028031	Z-GD-HC-H7-2,8	8AB	32,00 €	8AB0028034	Z-GD-HC-And-2,8	8AB	35,00 €	8AB0028032	Z-GD-HC-ZM-2,8	8AB	65,00 €
8AB0030031	Z-GD-HC-H7-3	8AB	32,00 €	8AB0030034	Z-GD-HC-And-3	8AB	35,00 €	8AB0030032	Z-GD-HC-ZM-3	8AB	65,00 €
8AB0035031	Z-GD-HC-H7-3,5	8AB	29,00 €	8AB0035034	Z-GD-HC-And-3,5	8AB	31,00 €	8AB0035032	Z-GD-HC-ZM-3,5	8AB	56,00 €
8AB0040031	Z-GD-HC-H7-4	8AB	29,00 €	8AB0040034	Z-GD-HC-And-4	8AB	31,00 €	8AB0040032	Z-GD-HC-ZM-4	8AB	56,00 €
8AB0045031	Z-GD-HC-H7-4,5	8AB	29,00 €	8AB0045034	Z-GD-HC-And-4,5	8AB	31,00 €	8AB0045032	Z-GD-HC-ZM-4,5	8AB	56,00 €
8AB0050031	Z-GD-HC-H7-5	8AB	27,00 €	8AB0050034	Z-GD-HC-And-5	8AB	29,00 €	8AB0050032	Z-GD-HC-ZM-5	8AB	51,00 €
8AB0055031	Z-GD-HC-H7-5,5	8AB	27,00 €	8AB0055034	Z-GD-HC-And-5,5	8AB	29,00 €	8AB0055032	Z-GD-HC-ZM-5,5	8AB	51,00 €
8AB0060031	Z-GD-HC-H7-6	8AB	27,00 €	8AB0060034	Z-GD-HC-And-6	8AB	29,00 €	8AB0060032	Z-GD-HC-ZM-6	8AB	51,00 €
8AB0070031	Z-GD-HC-H7-7	8AB	28,00 €	8AB0070034	Z-GD-HC-And-7	8AB	50,00 €	8AB0070032	Z-GD-HC-ZM-7	8AB	51,00 €
8AB0080031	Z-GD-HC-H7-8	8AB	29,00 €	8AB0080034	Z-GD-HC-And-8	8AB	52,00 €	8AB0080032	Z-GD-HC-ZM-8	8AB	53,00 €
8AB0090031	Z-GD-HC-H7-9	8AB	30,00 €	8AB0090034	Z-GD-HC-And-9	8AB	54,00 €	8AB0090032	Z-GD-HC-ZM-9	8AB	55,00 €
8AB0100031	Z-GD-HC-H7-10	8AB	31,00 €	8AB0100034	Z-GD-HC-And-10	8AB	34,00 €	8AB0100032	Z-GD-HC-ZM-10	8AB	56,00 €
8AB0110031	Z-GD-HC-H7-11	8AB	32,00 €	8AB0110034	Z-GD-HC-And-11	8AB	35,00 €	8AB0110032	Z-GD-HC-ZM-11	8AB	58,00 €
8AB0120031	Z-GD-HC-H7-12	8AB	33,00 €	8AB0120034	Z-GD-HC-And-12	8AB	35,00 €	8AB0120032	Z-GD-HC-ZM-12	8AB	60,00 €
8AB0130031	Z-GD-HC-H7-13	8AB	34,00 €	8AB0130034	Z-GD-HC-And-13	8AB	37,00 €	8AB0130032	Z-GD-HC-ZM-13	8AB	62,00 €
8AB0140031	Z-GD-HC-H7-14	8AB	35,00 €	8AB0140034	Z-GD-HC-And-14	8AB	38,00 €	8AB0140032	Z-GD-HC-ZM-14	8AB	64,00 €
8AB0150031	Z-GD-HC-H7-15	8AB	36,00 €	8AB0150034	Z-GD-HC-And-15	8AB	39,00 €	8AB0150032	Z-GD-HC-ZM-15	8AB	65,00 €
8AB0160031	Z-GD-HC-H7-16	8AB	37,00 €	8AB0160034	Z-GD-HC-And-16	8AB	40,00 €	8AB0160032	Z-GD-HC-ZM-16	8AB	67,00 €
8AB0170031	Z-GD-HC-H7-17	8AB	38,00 €	8AB0170034	Z-GD-HC-And-17	8AB	41,00 €	8AB0170032	Z-GD-HC-ZM-17	8AB	68,00 €
8AB0180031	Z-GD-HC-H7-18	8AB	39,00 €	8AB0180034	Z-GD-HC-And-18	8AB	42,00 €	8AB0180032	Z-GD-HC-ZM-18	8AB	71,00 €
8AB0190031	Z-GD-HC-H7-19	8AB	40,00 €	8AB0190034	Z-GD-HC-And-19	8AB	43,00 €	8AB0190032	Z-GD-HC-ZM-19	8AB	74,00 €
8AB0200031	Z-GD-HC-H7-20	8AB	40,00 €	8AB0200034	Z-GD-HC-And-20	8AB	43,00 €	8AB0200032	Z-GD-HC-ZM-20	8AB	74,00 €
8AB0210031	Z-GD-HC-H7-21	8AB	42,00 €	8AB0210034	Z-GD-HC-And-21	8AB	45,00 €	8AB0210032	Z-GD-HC-ZM-21	8AB	76,00 €
8AB0220031	Z-GD-HC-H7-22	8AB	43,00 €	8AB0220034	Z-GD-HC-And-22	8AB	46,00 €	8AB0220032	Z-GD-HC-ZM-22	8AB	77,00 €
8AB0230031	Z-GD-HC-H7-23	8AB	44,00 €	8AB0230034	Z-GD-HC-And-23	8AB	47,00 €	8AB0230032	Z-GD-HC-ZM-23	8AB	79,00 €

ANr.	Beschreibung	AGr.	Einzelpreis	ANr.	Beschreibung	AGr.	Einzelpreis	ANr.	Beschreibung	AGr.	Einzelpreis
<b>Gutlehrdorne, HC, ohne ZM, Passung H7</b>				<b>Gutlehrdorne, HC, ohne ZM, andere Passungen</b>				<b>Gutlehrdorne, HC, mit ZM</b>			
8AB0240031	Z-GD-HC-H7-24	8AB	45,00 €	8AB0240034	Z-GD-HC-And-24	8AB	49,00 €	8AB0240032	Z-GD-HC-ZM-24	8AB	81,00 €
8AB0250031	Z-GD-HC-H7-25	8AB	46,00 €	8AB0250034	Z-GD-HC-And-25	8AB	49,00 €	8AB0250032	Z-GD-HC-ZM-25	8AB	83,00 €
8AB0260031	Z-GD-HC-H7-26	8AB	47,00 €	8AB0260034	Z-GD-HC-And-26	8AB	50,00 €	8AB0260032	Z-GD-HC-ZM-26	8AB	85,00 €
8AB0270031	Z-GD-HC-H7-27	8AB	47,00 €	8AB0270034	Z-GD-HC-And-27	8AB	52,00 €	8AB0270032	Z-GD-HC-ZM-27	8AB	86,00 €
8AB0280031	Z-GD-HC-H7-28	8AB	49,00 €	8AB0280034	Z-GD-HC-And-28	8AB	53,00 €	8AB0280032	Z-GD-HC-ZM-28	8AB	88,00 €
8AB0300031	Z-GD-HC-H7-30	8AB	50,00 €	8AB0300034	Z-GD-HC-And-30	8AB	54,00 €	8AB0300032	Z-GD-HC-ZM-30	8AB	95,00 €
8AB0320031	Z-GD-HC-H7-32	8AB	53,00 €	8AB0320034	Z-GD-HC-And-32	8AB	58,00 €	8AB0320032	Z-GD-HC-ZM-32	8AB	98,00 €
8AB0330031	Z-GD-HC-H7-33	8AB	56,00 €	8AB0330034	Z-GD-HC-And-33	8AB	60,00 €	8AB0330032	Z-GD-HC-ZM-33	8AB	100,00 €
8AB0340031	Z-GD-HC-H7-34	8AB	56,00 €	8AB0340034	Z-GD-HC-And-34	8AB	61,00 €	8AB0340032	Z-GD-HC-ZM-34	8AB	102,00 €
8AB0350031	Z-GD-HC-H7-35	8AB	58,00 €	8AB0350034	Z-GD-HC-And-35	8AB	62,00 €	8AB0350032	Z-GD-HC-ZM-35	8AB	104,00 €
8AB0360031	Z-GD-HC-H7-36	8AB	59,00 €	8AB0360034	Z-GD-HC-And-36	8AB	64,00 €	8AB0360032	Z-GD-HC-ZM-36	8AB	106,00 €
8AB0370031	Z-GD-HC-H7-37	8AB	59,00 €	8AB0370034	Z-GD-HC-And-37	8AB	64,00 €	8AB0370032	Z-GD-HC-ZM-37	8AB	109,00 €
8AB0380031	Z-GD-HC-H7-38	8AB	62,00 €	8AB0380034	Z-GD-HC-And-38	8AB	67,00 €	8AB0380032	Z-GD-HC-ZM-38	8AB	113,00 €
8AB0400031	Z-GD-HC-H7-40	8AB	64,00 €	8AB0400034	Z-GD-HC-And-40	8AB	68,00 €	8AB0400032	Z-GD-HC-ZM-40	8AB	116,00 €
8AB0420031	Z-GD-HC-H7-42	8AB	65,00 €	8AB0420034	Z-GD-HC-And-42	8AB	71,00 €	8AB0420032	Z-GD-HC-ZM-4	8AB	123,00 €
8AB0440031	Z-GD-HC-H7-44	8AB	70,00 €	8AB0440034	Z-GD-HC-And-44	8AB	75,00 €	8AB0440032	Z-GD-HC-ZM-44	8AB	127,00 €
8AB0450031	Z-GD-HC-H7-45	8AB	71,00 €	8AB0450034	Z-GD-HC-And-45	8AB	77,00 €	8AB0450032	Z-GD-HC-ZM-45	8AB	130,00 €
8AB0460031	Z-GD-HC-H7-46	8AB	73,00 €	8AB0460034	Z-GD-HC-And-46	8AB	79,00 €	8AB0460032	Z-GD-HC-ZM-46	8AB	134,00 €
8AB0470031	Z-GD-HC-H7-47	8AB	76,00 €	8AB0470034	Z-GD-HC-And-47	8AB	82,00 €	8AB0470032	Z-GD-HC-ZM-47	8AB	137,00 €
8AB0480031	Z-GD-HC-H7-48	8AB	77,00 €	8AB0480034	Z-GD-HC-And-48	8AB	83,00 €	8AB0480032	Z-GD-HC-ZM-48	8AB	141,00 €
8AB0500031	Z-GD-HC-H7-50	8AB	79,00 €	8AB0500034	Z-GD-HC-And-50	8AB	86,00 €	8AB0500032	Z-GD-HC-ZM-50	8AB	148,00 €
8AB0520031	Z-GD-HC-H7-52	8AB	83,00 €	8AB0520034	Z-GD-HC-And-52	8AB	90,00 €	8AB0520032	Z-GD-HC-ZM-52	8AB	155,00 €
8AB0550031	Z-GD-HC-H7-55	8AB	87,00 €	8AB0550034	Z-GD-HC-And-55	8AB	94,00 €	8AB0550032	Z-GD-HC-ZM-55	8AB	166,00 €
8AB0580031	Z-GD-HC-H7-58	8AB	93,00 €	8AB0580034	Z-GD-HC-And-58	8AB	101,00 €	8AB0580032	Z-GD-HC-ZM-58	8AB	172,00 €
8AB0600031	Z-GD-HC-H7-60	8AB	97,00 €	8AB0600034	Z-GD-HC-And-60	8AB	105,00 €	8AB0600032	Z-GD-HC-ZM-60	8AB	179,00 €
8AB0620031	Z-GD-HC-H7-62	8AB	101,00 €	8AB0620034	Z-GD-HC-And-62	8AB	109,00 €	8AB0620032	Z-GD-HC-ZM-62	8AB	185,00 €
8AB0650031	Z-GD-HC-H7-65	8AB	104,00 €	8AB0650034	Z-GD-HC-And-65	8AB	113,00 €	8AB0650032	Z-GD-HC-ZM-65	8AB	197,00 €
8AB0680031	Z-GD-HC-H7-68	8AB	111,00 €	8AB0680034	Z-GD-HC-And-68	8AB	120,00 €	8AB0680032	Z-GD-HC-ZM-68	8AB	200,00 €
8AB0700031	Z-GD-HC-H7-70	8AB	113,00 €	8AB0700034	Z-GD-HC-And-70	8AB	122,00 €	8AB0700032	Z-GD-HC-ZM-70	8AB	209,00 €
8AB0720031	Z-GD-HC-H7-72	8AB	118,00 €	8AB0720034	Z-GD-HC-And-72	8AB	127,00 €	8AB0720032	Z-GD-HC-ZM-72	8AB	218,00 €
8AB0750031	Z-GD-HC-H7-75	8AB	123,00 €	8AB0750034	Z-GD-HC-And-75	8AB	133,00 €	8AB0750032	Z-GD-HC-ZM-75	8AB	229,00 €
8AB0780031	Z-GD-HC-H7-78	8AB	129,00 €	8AB0780034	Z-GD-HC-And-78	8AB	139,00 €	8AB0780032	Z-GD-HC-ZM-78	8AB	232,00 €
8AB0800031	Z-GD-HC-H7-80	8AB	131,00 €	8AB0800034	Z-GD-HC-And-80	8AB	142,00 €	8AB0800032	Z-GD-HC-ZM-80	8AB	239,00 €
8AB0820031	Z-GD-HC-H7-82	8AB	134,00 €	8AB0820034	Z-GD-HC-And-82	8AB	146,00 €	8AB0820032	Z-GD-HC-ZM-82	8AB	246,00 €
8AB0850031	Z-GD-HC-H7-85	8AB	139,00 €	8AB0850034	Z-GD-HC-And-85	8AB	150,00 €	8AB0850032	Z-GD-HC-ZM-85	8AB	256,00 €
8AB0880031	Z-GD-HC-H7-88	8AB	145,00 €	8AB0880034	Z-GD-HC-And-88	8AB	156,00 €	8AB0880032	Z-GD-HC-ZM-88	8AB	264,00 €
8AB0900031	Z-GD-HC-H7-90	8AB	148,00 €	8AB0900034	Z-GD-HC-And-90	8AB	161,00 €	8AB0900032	Z-GD-HC-ZM-90	8AB	271,00 €
8AB0920031	Z-GD-HC-H7-92	8AB	152,00 €	8AB0920034	Z-GD-HC-And-92	8AB	165,00 €	8AB0920032	Z-GD-HC-ZM-92	8AB	278,00 €
8AB0950031	Z-GD-HC-H7-95	8AB	157,00 €	8AB0950034	Z-GD-HC-And-95	8AB	169,00 €	8AB0950032	Z-GD-HC-ZM-95	8AB	289,00 €
8AB0980031	Z-GD-HC-H7-98	8AB	163,00 €	8AB0980034	Z-GD-HC-And-98	8AB	176,00 €	8AB0980032	Z-GD-HC-ZM-98	8AB	295,00 €
8AB1000031	Z-GD-HC-H7-100	8AB	166,00 €	8AB1000034	Z-GD-HC-And-100	8AB	180,00 €	8AB1000032	Z-GD-HC-ZM-100	8AB	307,00 €



Anr.	Beschreibung	AGr.	Einzelpreis	Anr.	Beschreibung	AGr.	Einzelpreis	Anr.	Beschreibung	AGr.	Einzelpreis
------	--------------	------	-------------	------	--------------	------	-------------	------	--------------	------	-------------

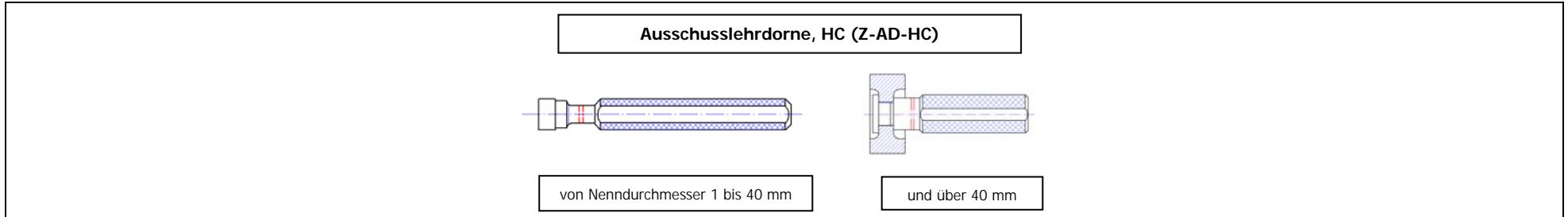

Ausschusslehrdorne, HC, ohne ZM, Passung H7				Ausschusslehrdorne, HC, ohne ZM, andere Passungen				Ausschusslehrdorne, HC, mit ZM			
8AC0010031	Z-AD-HC-H7-1	8AC	46,00 €	8AC0010034	Z-AD-HC-And-1	8AC	49,00 €	8AC0010032	Z-AD-HC-ZM-1	8AC	81,00 €
8AC0012031	Z-AD-HC-H7-1,2	8AC	42,00 €	8AC0012034	Z-AD-HC-And-1,2	8AC	45,00 €	8AC0012032	Z-AD-HC-ZM-1,2	8AC	81,00 €
8AC0015031	Z-AD-HC-H7-1,5	8AC	42,00 €	8AC0015034	Z-AD-HC-And-1,5	8AC	45,00 €	8AC0015032	Z-AD-HC-ZM-1,5	8AC	81,00 €
8AC0018031	Z-AD-HC-H7-1,8	8AC	42,00 €	8AC0018034	Z-AD-HC-And-1,8	8AC	45,00 €	8AC0018032	Z-AD-HC-ZM-1,8	8AC	81,00 €
8AC0020031	Z-AD-HC-H7-2	8AC	37,00 €	8AC0020034	Z-AD-HC-And-2	8AC	40,00 €	8AC0020032	Z-AD-HC-ZM-2	8AC	74,00 €
8AC0022031	Z-AD-HC-H7-2,2	8AC	37,00 €	8AC0022034	Z-AD-HC-And-2,2	8AC	40,00 €	8AC0022032	Z-AD-HC-ZM-2,2	8AC	74,00 €
8AC0025031	Z-AD-HC-H7-2,5	8AC	37,00 €	8AC0025034	Z-AD-HC-And-2,5	8AC	40,00 €	8AC0025032	Z-AD-HC-ZM-2,5	8AC	74,00 €
8AC0028031	Z-AD-HC-H7-2,8	8AC	32,00 €	8AC0028034	Z-AD-HC-And-2,8	8AC	35,00 €	8AC0028032	Z-AD-HC-ZM-2,8	8AC	65,00 €
8AC0030031	Z-AD-HC-H7-3	8AC	32,00 €	8AC0030034	Z-AD-HC-And-3	8AC	35,00 €	8AC0030032	Z-AD-HC-ZM-3	8AC	65,00 €
8AC0035031	Z-AD-HC-H7-3,5	8AC	29,00 €	8AC0035034	Z-AD-HC-And-3,5	8AC	31,00 €	8AC0035032	Z-AD-HC-ZM-3,5	8AC	56,00 €
8AC0040031	Z-AD-HC-H7-4	8AC	29,00 €	8AC0040034	Z-AD-HC-And-4	8AC	31,00 €	8AC0040032	Z-AD-HC-ZM-4	8AC	56,00 €
8AC0045031	Z-AD-HC-H7-4,5	8AC	29,00 €	8AC0045034	Z-AD-HC-And-4,5	8AC	31,00 €	8AC0045032	Z-AD-HC-ZM-4,5	8AC	56,00 €
8AC0050031	Z-AD-HC-H7-5	8AC	27,00 €	8AC0050034	Z-AD-HC-And-5	8AC	29,00 €	8AC0050032	Z-AD-HC-ZM-5	8AC	51,00 €
8AC0055031	Z-AD-HC-H7-5,5	8AC	27,00 €	8AC0055034	Z-AD-HC-And-5,5	8AC	29,00 €	8AC0055032	Z-AD-HC-ZM-5,5	8AC	51,00 €
8AC0060031	Z-AD-HC-H7-6	8AC	27,00 €	8AC0060034	Z-AD-HC-And-6	8AC	29,00 €	8AC0060032	Z-AD-HC-ZM-6	8AC	51,00 €
8AC0070031	Z-AD-HC-H7-7	8AC	47,00 €	8AC0070034	Z-AD-HC-And-7	8AC	30,00 €	8AC0070032	Z-AD-HC-ZM-7	8AC	51,00 €
8AC0080031	Z-AD-HC-H7-8	8AC	48,00 €	8AC0080034	Z-AD-HC-And-8	8AC	31,00 €	8AC0080032	Z-AD-HC-ZM-8	8AC	53,00 €
8AC0090031	Z-AD-HC-H7-9	8AC	50,00 €	8AC0090034	Z-AD-HC-And-9	8AC	32,00 €	8AC0090032	Z-AD-HC-ZM-9	8AC	55,00 €
8AC0100031	Z-AD-HC-H7-10	8AC	31,00 €	8AC0100034	Z-AD-HC-And-10	8AC	34,00 €	8AC0100032	Z-AD-HC-ZM-10	8AC	56,00 €
8AC0110031	Z-AD-HC-H7-11	8AC	32,00 €	8AC0110034	Z-AD-HC-And-11	8AC	34,00 €	8AC0110032	Z-AD-HC-ZM-11	8AC	58,00 €
8AC0120031	Z-AD-HC-H7-12	8AC	33,00 €	8AC0120034	Z-AD-HC-And-12	8AC	35,00 €	8AC0120032	Z-AD-HC-ZM-12	8AC	60,00 €
8AC0130031	Z-AD-HC-H7-13	8AC	34,00 €	8AC0130034	Z-AD-HC-And-13	8AC	35,00 €	8AC0130032	Z-AD-HC-ZM-13	8AC	62,00 €
8AC0140031	Z-AD-HC-H7-14	8AC	35,00 €	8AC0140034	Z-AD-HC-And-14	8AC	37,00 €	8AC0140032	Z-AD-HC-ZM-14	8AC	64,00 €
8AC0150031	Z-AD-HC-H7-15	8AC	36,00 €	8AC0150034	Z-AD-HC-And-15	8AC	38,00 €	8AC0150032	Z-AD-HC-ZM-15	8AC	65,00 €
8AC0160031	Z-AD-HC-H7-16	8AC	37,00 €	8AC0160034	Z-AD-HC-And-16	8AC	39,00 €	8AC0160032	Z-AD-HC-ZM-16	8AC	67,00 €
8AC0170031	Z-AD-HC-H7-17	8AC	38,00 €	8AC0170034	Z-AD-HC-And-17	8AC	40,00 €	8AC0170032	Z-AD-HC-ZM-17	8AC	68,00 €
8AC0180031	Z-AD-HC-H7-18	8AC	39,00 €	8AC0180034	Z-AD-HC-And-18	8AC	41,00 €	8AC0180032	Z-AD-HC-ZM-18	8AC	71,00 €
8AC0190031	Z-AD-HC-H7-19	8AC	40,00 €	8AC0190034	Z-AD-HC-And-19	8AC	42,00 €	8AC0190032	Z-AD-HC-ZM-19	8AC	74,00 €
8AC0200031	Z-AD-HC-H7-20	8AC	40,00 €	8AC0200034	Z-AD-HC-And-20	8AC	43,00 €	8AC0200032	Z-AD-HC-ZM-20	8AC	74,00 €
8AC0210031	Z-AD-HC-H7-21	8AC	42,00 €	8AC0210034	Z-AD-HC-And-21	8AC	43,00 €	8AC0210032	Z-AD-HC-ZM-21	8AC	76,00 €
8AC0220031	Z-AD-HC-H7-22	8AC	43,00 €	8AC0220034	Z-AD-HC-And-22	8AC	45,00 €	8AC0220032	Z-AD-HC-ZM-22	8AC	77,00 €
8AC0230031	Z-AD-HC-H7-23	8AC	44,00 €	8AC0230034	Z-AD-HC-And-23	8AC	46,00 €	8AC0230032	Z-AD-HC-ZM-23	8AC	79,00 €



ANr.	Beschreibung	AGr.	Einzelpreis	ANr.	Beschreibung	AGr.	Einzelpreis	ANr.	Beschreibung	AGr.	Einzelpreis
<b>Ausschusslehrdorne, HC, ohne ZM, Passung H7</b>				<b>Ausschusslehrdorne, HC, ohne ZM, andere Passungen</b>				<b>Ausschusslehrdorne, HC, mit ZM</b>			
8AC0240031	Z-AD-HC-H7-24	8AC	45,00 €	8AC0240034	Z-AD-HC-And-24	8AC	47,00 €	8AC0240032	Z-AD-HC-ZM-24	8AC	81,00 €
8AC0250031	Z-AD-HC-H7-25	8AC	46,00 €	8AC0250034	Z-AD-HC-And-25	8AC	49,00 €	8AC0250032	Z-AD-HC-ZM-25	8AC	83,00 €
8AC0260031	Z-AD-HC-H7-26	8AC	47,00 €	8AC0260034	Z-AD-HC-And-26	8AC	49,00 €	8AC0260032	Z-AD-HC-ZM-26	8AC	85,00 €
8AC0270031	Z-AD-HC-H7-27	8AC	47,00 €	8AC0270034	Z-AD-HC-And-27	8AC	50,00 €	8AC0270032	Z-AD-HC-ZM-27	8AC	86,00 €
8AC0280031	Z-AD-HC-H7-28	8AC	49,00 €	8AC0280034	Z-AD-HC-And-28	8AC	52,00 €	8AC0280032	Z-AD-HC-ZM-28	8AC	88,00 €
8AC0300031	Z-AD-HC-H7-30	8AC	50,00 €	8AC0300034	Z-AD-HC-And-30	8AC	53,00 €	8AC0300032	Z-AD-HC-ZM-30	8AC	95,00 €
8AC0320031	Z-AD-HC-H7-32	8AC	53,00 €	8AC0320034	Z-AD-HC-And-32	8AC	54,00 €	8AC0320032	Z-AD-HC-ZM-32	8AC	98,00 €
8AC0330031	Z-AD-HC-H7-33	8AC	56,00 €	8AC0330034	Z-AD-HC-And-33	8AC	58,00 €	8AC0330032	Z-AD-HC-ZM-33	8AC	100,00 €
8AC0340031	Z-AD-HC-H7-34	8AC	56,00 €	8AC0340034	Z-AD-HC-And-34	8AC	60,00 €	8AC0340032	Z-AD-HC-ZM-34	8AC	102,00 €
8AC0350031	Z-AD-HC-H7-35	8AC	58,00 €	8AC0350034	Z-AD-HC-And-35	8AC	61,00 €	8AC0350032	Z-AD-HC-ZM-35	8AC	104,00 €
8AC0360031	Z-AD-HC-H7-36	8AC	59,00 €	8AC0360034	Z-AD-HC-And-36	8AC	62,00 €	8AC0360032	Z-AD-HC-ZM-36	8AC	106,00 €
8AC0370031	Z-AD-HC-H7-37	8AC	59,00 €	8AC0370034	Z-AD-HC-And-37	8AC	64,00 €	8AC0370032	Z-AD-HC-ZM-37	8AC	109,00 €
8AC0380031	Z-AD-HC-H7-38	8AC	62,00 €	8AC0380034	Z-AD-HC-And-38	8AC	67,00 €	8AC0380032	Z-AD-HC-ZM-38	8AC	113,00 €
8AC0400031	Z-AD-HC-H7-40	8AC	64,00 €	8AC0400034	Z-AD-HC-And-40	8AC	68,00 €	8AC0400032	Z-AD-HC-ZM-40	8AC	116,00 €
8AC0420031	Z-AD-HC-H7-42	8AC	65,00 €	8AC0420034	Z-AD-HC-And-42	8AC	71,00 €	8AC0420032	Z-AD-HC-ZM-42	8AC	123,00 €
8AC0440031	Z-AD-HC-H7-44	8AC	70,00 €	8AC0440034	Z-AD-HC-And-44	8AC	75,00 €	8AC0440032	Z-AD-HC-ZM-44	8AC	127,00 €
8AC0450031	Z-AD-HC-H7-45	8AC	71,00 €	8AC0450034	Z-AD-HC-And-45	8AC	77,00 €	8AC0450032	Z-AD-HC-ZM-45	8AC	130,00 €
8AC0460031	Z-AD-HC-H7-46	8AC	73,00 €	8AC0460034	Z-AD-HC-And-46	8AC	79,00 €	8AC0460032	Z-AD-HC-ZM-46	8AC	134,00 €
8AC0470031	Z-AD-HC-H7-47	8AC	76,00 €	8AC0470034	Z-AD-HC-And-47	8AC	82,00 €	8AC0470032	Z-AD-HC-ZM-47	8AC	137,00 €
8AC0480031	Z-AD-HC-H7-48	8AC	77,00 €	8AC0480034	Z-AD-HC-And-48	8AC	83,00 €	8AC0480032	Z-AD-HC-ZM-48	8AC	141,00 €
8AC0500031	Z-AD-HC-H7-50	8AC	79,00 €	8AC0500034	Z-AD-HC-And-50	8AC	86,00 €	8AC0500032	Z-AD-HC-ZM-50	8AC	148,00 €
8AC0520031	Z-AD-HC-H7-52	8AC	83,00 €	8AC0520034	Z-AD-HC-And-52	8AC	90,00 €	8AC0520032	Z-AD-HC-ZM-52	8AC	155,00 €
8AC0550031	Z-AD-HC-H7-55	8AC	87,00 €	8AC0550034	Z-AD-HC-And-55	8AC	94,00 €	8AC0550032	Z-AD-HC-ZM-55	8AC	166,00 €
8AC0580031	Z-AD-HC-H7-58	8AC	93,00 €	8AC0580034	Z-AD-HC-And-58	8AC	101,00 €	8AC0580032	Z-AD-HC-ZM-58	8AC	172,00 €
8AC0600031	Z-AD-HC-H7-60	8AC	97,00 €	8AC0600034	Z-AD-HC-And-60	8AC	105,00 €	8AC0600032	Z-AD-HC-ZM-60	8AC	179,00 €
8AC0620031	Z-AD-HC-H7-62	8AC	101,00 €	8AC0620034	Z-AD-HC-And-62	8AC	109,00 €	8AC0620032	Z-AD-HC-ZM-62	8AC	185,00 €
8AC0650031	Z-AD-HC-H7-65	8AC	104,00 €	8AC0650034	Z-AD-HC-And-65	8AC	113,00 €	8AC0650032	Z-AD-HC-ZM-65	8AC	197,00 €
8AC0680031	Z-AD-HC-H7-68	8AC	111,00 €	8AC0680034	Z-AD-HC-And-68	8AC	120,00 €	8AC0680032	Z-AD-HC-ZM-68	8AC	200,00 €
8AC0700031	Z-AD-HC-H7-70	8AC	113,00 €	8AC0700034	Z-AD-HC-And-70	8AC	122,00 €	8AC0700032	Z-AD-HC-ZM-70	8AC	209,00 €
8AC0720031	Z-AD-HC-H7-72	8AC	118,00 €	8AC0720034	Z-AD-HC-And-72	8AC	127,00 €	8AC0720032	Z-AD-HC-ZM-72	8AC	218,00 €
8AC0750031	Z-AD-HC-H7-75	8AC	123,00 €	8AC0750034	Z-AD-HC-And-75	8AC	133,00 €	8AC0750032	Z-AD-HC-ZM-75	8AC	229,00 €
8AC0780031	Z-AD-HC-H7-78	8AC	129,00 €	8AC0780034	Z-AD-HC-And-78	8AC	139,00 €	8AC0780032	Z-AD-HC-ZM-78	8AC	232,00 €
8AC0800031	Z-AD-HC-H7-80	8AC	131,00 €	8AC0800034	Z-AD-HC-And-80	8AC	142,00 €	8AC0800032	Z-AD-HC-ZM-80	8AC	239,00 €
8AC0820031	Z-AD-HC-H7-82	8AC	134,00 €	8AC0820034	Z-AD-HC-And-82	8AC	146,00 €	8AC0820032	Z-AD-HC-ZM-82	8AC	246,00 €
8AC0850031	Z-AD-HC-H7-85	8AC	139,00 €	8AC0850034	Z-AD-HC-And-85	8AC	150,00 €	8AC0850032	Z-AD-HC-ZM-85	8AC	256,00 €
8AC0880031	Z-AD-HC-H7-88	8AC	145,00 €	8AC0880034	Z-AD-HC-And-88	8AC	156,00 €	8AC0880032	Z-AD-HC-ZM-88	8AC	264,00 €
8AC0900031	Z-AD-HC-H7-90	8AC	148,00 €	8AC0900034	Z-AD-HC-And-90	8AC	161,00 €	8AC0900032	Z-AD-HC-ZM-90	8AC	271,00 €
8AC0920031	Z-AD-HC-H7-92	8AC	152,00 €	8AC0920034	Z-AD-HC-And-92	8AC	165,00 €	8AC0920032	Z-AD-HC-ZM-92	8AC	278,00 €
8AC0950031	Z-AD-HC-H7-95	8AC	157,00 €	8AC0950034	Z-AD-HC-And-95	8AC	169,00 €	8AC0950032	Z-AD-HC-ZM-95	8AC	289,00 €
8AC0980031	Z-AD-HC-H7-98	8AC	163,00 €	8AC0980034	Z-AD-HC-And-98	8AC	176,00 €	8AC0980032	Z-AD-HC-ZM-98	8AC	295,00 €
8AC1000031	Z-AD-HC-H7-100	8AC	166,00 €	8AC1000034	Z-AD-HC-And-100	8AC	180,00 €	8AC1000032	Z-AD-HC-ZM-100	8AC	307,00 €

ANr.	Beschreibung	AGr.	Einzelpreis	ANr.	Beschreibung	AGr.	Einzelpreis	ANr.	Beschreibung	AGr.	Einzelpreis
------	--------------	------	-------------	------	--------------	------	-------------	------	--------------	------	-------------

Grenzlehrdorne, GHM (Z-GLD-GHM) / HM (Z-GLD-HM)



von Nenndurchmesser 1 bis 50 mm

Grenzlehrdorne, GHM, ohne ZM, Passung H7				Grenzlehrdorne, GHM, ohne ZM, andere Passungen				Grenzlehrdorne, GHM, mit ZM			
8AA0020041	Z-GLD-GHM-H7-2	8AA	88,00 €	8AA0020044	Z-GLD-GHM-And-2	8AA	88,00 €	8AA0020042	Z-GLD-GHM-ZM-2	8AA	120,00 €
8AA0030041	Z-GLD-GHM-H7-3	8AA	93,00 €	8AA0030044	Z-GLD-GHM-And-3	8AA	93,00 €	8AA0030042	Z-GLD-GHM-ZM-3	8AA	134,00 €
8AA0040041	Z-GLD-GHM-H7-4	8AA	103,00 €	8AA0040044	Z-GLD-GHM-And-4	8AA	103,00 €	8AA0040042	Z-GLD-GHM-ZM-4	8AA	145,00 €
8AA0050041	Z-GLD-GHM-H7-5	8AA	112,00 €	8AA0050044	Z-GLD-GHM-And-5	8AA	112,00 €	8AA0050042	Z-GLD-GHM-ZM-5	8AA	152,00 €
8AA0060041	Z-GLD-GHM-H7-6	8AA	117,00 €	8AA0060044	Z-GLD-GHM-And-6	8AA	117,00 €	8AA0060042	Z-GLD-GHM-ZM-6	8AA	158,00 €
8AA0070041	Z-GLD-GHM-H7-7	8AA	122,00 €	8AA0070044	Z-GLD-GHM-And-7	8AA	122,00 €	8AA0070042	Z-GLD-GHM-ZM-7	8AA	170,00 €
8AA0080041	Z-GLD-GHM-H7-8	8AA	131,00 €	8AA0080044	Z-GLD-GHM-And-8	8AA	131,00 €	8AA0080042	Z-GLD-GHM-ZM-8	8AA	187,00 €
8AA0090041	Z-GLD-GHM-H7-9	8AA	144,00 €	8AA0090044	Z-GLD-GHM-And-9	8AA	144,00 €	8AA0090042	Z-GLD-GHM-ZM-9	8AA	204,00 €
8AA0100041	Z-GLD-GHM-H7-10	8AA	157,00 €	8AA0100044	Z-GLD-GHM-And-10	8AA	157,00 €	8AA0100042	Z-GLD-GHM-ZM-10	8AA	209,00 €
8AA0110041	Z-GLD-GHM-H7-11	8AA	161,00 €	8AA0110044	Z-GLD-GHM-And-11	8AA	161,00 €	8AA0110042	Z-GLD-GHM-ZM-11	8AA	217,00 €
8AA0120041	Z-GLD-GHM-H7-12	8AA	167,00 €	8AA0120044	Z-GLD-GHM-And-12	8AA	167,00 €	8AA0120042	Z-GLD-GHM-ZM-12	8AA	226,00 €
8AA0130041	Z-GLD-GHM-H7-13	8AA	174,00 €	8AA0130044	Z-GLD-GHM-And-13	8AA	174,00 €	8AA0130042	Z-GLD-GHM-ZM-13	8AA	234,00 €
8AA0140041	Z-GLD-GHM-H7-14	8AA	180,00 €	8AA0140044	Z-GLD-GHM-And-14	8AA	180,00 €	8AA0140042	Z-GLD-GHM-ZM-14	8AA	244,00 €
8AA0150041	Z-GLD-GHM-H7-15	8AA	188,00 €	8AA0150044	Z-GLD-GHM-And-15	8AA	188,00 €	8AA0150042	Z-GLD-GHM-ZM-15	8AA	253,00 €
8AA0160041	Z-GLD-GHM-H7-16	8AA	195,00 €	8AA0160044	Z-GLD-GHM-And-16	8AA	195,00 €	8AA0160042	Z-GLD-GHM-ZM-16	8AA	261,00 €
8AA0170041	Z-GLD-GHM-H7-17	8AA	201,00 €	8AA0170044	Z-GLD-GHM-And-17	8AA	201,00 €	8AA0170042	Z-GLD-GHM-ZM-17	8AA	270,00 €
8AA0180041	Z-GLD-GHM-H7-18	8AA	208,00 €	8AA0180044	Z-GLD-GHM-And-18	8AA	208,00 €	8AA0180042	Z-GLD-GHM-ZM-18	8AA	276,00 €
8AA0190041	Z-GLD-GHM-H7-19	8AA	212,00 €	8AA0190044	Z-GLD-GHM-And-19	8AA	212,00 €	8AA0190042	Z-GLD-GHM-ZM-19	8AA	284,00 €
8AA0200041	Z-GLD-GHM-H7-20	8AA	218,00 €	8AA0200044	Z-GLD-GHM-And-20	8AA	218,00 €	8AA0200042	Z-GLD-GHM-ZM-20	8AA	293,00 €
8AA0210041	Z-GLD-GHM-H7-21	8AA	225,00 €	8AA0210044	Z-GLD-GHM-And-21	8AA	225,00 €	8AA0210042	Z-GLD-GHM-ZM-21	8AA	301,00 €
8AA0220041	Z-GLD-GHM-H7-22	8AA	231,00 €	8AA0220044	Z-GLD-GHM-And-22	8AA	231,00 €	8AA0220042	Z-GLD-GHM-ZM-22	8AA	310,00 €
8AA0230041	Z-GLD-GHM-H7-23	8AA	239,00 €	8AA0230044	Z-GLD-GHM-And-23	8AA	239,00 €	8AA0230042	Z-GLD-GHM-ZM-23	8AA	320,00 €
8AA0240041	Z-GLD-GHM-H7-24	8AA	246,00 €	8AA0240044	Z-GLD-GHM-And-24	8AA	246,00 €	8AA0240042	Z-GLD-GHM-ZM-24	8AA	384,00 €
8AA0250041	Z-GLD-GHM-H7-25	8AA	296,00 €	8AA0250044	Z-GLD-GHM-And-25	8AA	296,00 €	8AA0250042	Z-GLD-GHM-ZM-25	8AA	390,00 €
8AA0260041	Z-GLD-GHM-H7-26	8AA	300,00 €	8AA0260044	Z-GLD-GHM-And-26	8AA	300,00 €	8AA0260042	Z-GLD-GHM-ZM-26	8AA	409,00 €
8AA0270041	Z-GLD-GHM-H7-27	8AA	315,00 €	8AA0270044	Z-GLD-GHM-And-27	8AA	315,00 €	8AA0270042	Z-GLD-GHM-ZM-27	8AA	422,00 €
8AA0280041	Z-GLD-GHM-H7-28	8AA	325,00 €	8AA0280044	Z-GLD-GHM-And-28	8AA	325,00 €	8AA0280042	Z-GLD-GHM-ZM-28	8AA	447,00 €
8AA0300041	Z-GLD-GHM-H7-30	8AA	344,00 €	8AA0300044	Z-GLD-GHM-And-30	8AA	344,00 €	8AA0300042	Z-GLD-GHM-ZM-30	8AA	472,00 €
8AA0320041	Z-GLD-GHM-H7-32	8AA	363,00 €	8AA0320044	Z-GLD-GHM-And-32	8AA	363,00 €	8AA0320042	Z-GLD-GHM-ZM-32	8AA	482,00 €
8AA0330041	Z-GLD-GHM-H7-33	8AA	373,00 €	8AA0330044	Z-GLD-GHM-And-33	8AA	373,00 €	8AA0330042	Z-GLD-GHM-ZM-33	8AA	498,00 €
8AA0340041	Z-GLD-GHM-H7-34	8AA	384,00 €	8AA0340044	Z-GLD-GHM-And-34	8AA	384,00 €	8AA0340042	Z-GLD-GHM-ZM-34	8AA	511,00 €
8AA0350041	Z-GLD-GHM-H7-35	8AA	394,00 €	8AA0350044	Z-GLD-GHM-And-35	8AA	394,00 €	8AA0350042	Z-GLD-GHM-ZM-35	8AA	525,00 €
8AA0360041	Z-GLD-GHM-H7-36	8AA	404,00 €	8AA0360044	Z-GLD-GHM-And-36	8AA	404,00 €	8AA0360042	Z-GLD-GHM-ZM-36	8AA	538,00 €

Anr.	Beschreibung	AGr.	Einzelpreis	Anr.	Beschreibung	AGr.	Einzelpreis	Anr.	Beschreibung	AGr.	Einzelpreis
<b>Grenzlehrdorne, GHM, ohne ZM, Passung H7</b>				<b>Grenzlehrdorne, GHM, ohne ZM, andere Passungen</b>				<b>Grenzlehrdorne, GHM, mit ZM</b>			
8AA0370041	Z-GLD-GHM-H7-37	8AA	414,00 €	8AA0370044	Z-GLD-GHM-And-37	8AA	414,00 €	8AA0370042	Z-GLD-GHM-ZM-37	8AA	552,00 €
8AA0380041	Z-GLD-GHM-H7-38	8AA	424,00 €	8AA0380044	Z-GLD-GHM-And-38	8AA	424,00 €	8AA0380042	Z-GLD-GHM-ZM-38	8AA	578,00 €
8AA0400041	Z-GLD-GHM-H7-40	8AA	445,00 €	8AA0400044	Z-GLD-GHM-And-40	8AA	445,00 €	8AA0400042	Z-GLD-GHM-ZM-40	8AA	610,00 €
8AA0420041	Z-GLD-GHM-H7-42	8AA	470,00 €	8AA0420044	Z-GLD-GHM-And-42	8AA	470,00 €	8AA0420042	Z-GLD-GHM-ZM-42	8AA	641,00 €
8AA0440041	Z-GLD-GHM-H7-44	8AA	493,00 €	8AA0440044	Z-GLD-GHM-And-44	8AA	493,00 €	8AA0440042	Z-GLD-GHM-ZM-44	8AA	656,00 €
8AA0450041	Z-GLD-GHM-H7-45	8AA	505,00 €	8AA0450044	Z-GLD-GHM-And-45	8AA	505,00 €	8AA0450042	Z-GLD-GHM-ZM-45	8AA	673,00 €
8AA0460041	Z-GLD-GHM-H7-46	8AA	518,00 €	8AA0460044	Z-GLD-GHM-And-46	8AA	518,00 €	8AA0460042	Z-GLD-GHM-ZM-46	8AA	688,00 €
8AA0470041	Z-GLD-GHM-H7-47	8AA	530,00 €	8AA0470044	Z-GLD-GHM-And-47	8AA	530,00 €	8AA0470042	Z-GLD-GHM-ZM-47	8AA	704,00 €
8AA0480041	Z-GLD-GHM-H7-48	8AA	541,00 €	8AA0480044	Z-GLD-GHM-And-48	8AA	541,00 €	8AA0480042	Z-GLD-GHM-ZM-48	8AA	732,00 €
8AA0500041	Z-GLD-GHM-H7-50	8AA	563,00 €	8AA0500044	Z-GLD-GHM-And-50	8AA	563,00 €	8AA0500042	Z-GLD-GHM-ZM-50	8AA	754,00 €

<b>Grenzlehrdorne, HM, ohne ZM, Passung H7</b>				<b>Grenzlehrdorne, HM, ohne ZM, andere Passungen</b>				<b>Grenzlehrdorne, HM, mit ZM</b>			
8AA0020051	Z-GLD-HM-H7-2	8AA	117,00 €	8AA0020054	Z-GLD-HM-And-2	8AA	117,00 €	8AA0020052	Z-GLD-HM-ZM-2	8AA	156,00 €
8AA0030051	Z-GLD-HM-H7-3	8AA	120,00 €	8AA0030054	Z-GLD-HM-And-3	8AA	120,00 €	8AA0030052	Z-GLD-HM-ZM-3	8AA	168,00 €
8AA0040051	Z-GLD-HM-H7-4	8AA	129,00 €	8AA0040054	Z-GLD-HM-And-4	8AA	129,00 €	8AA0040052	Z-GLD-HM-ZM-4	8AA	179,00 €
8AA0050051	Z-GLD-HM-H7-5	8AA	138,00 €	8AA0050054	Z-GLD-HM-And-5	8AA	138,00 €	8AA0050052	Z-GLD-HM-ZM-5	8AA	190,00 €
8AA0060051	Z-GLD-HM-H7-6	8AA	147,00 €	8AA0060054	Z-GLD-HM-And-6	8AA	147,00 €	8AA0060052	Z-GLD-HM-ZM-6	8AA	204,00 €
8AA0070051	Z-GLD-HM-H7-7	8AA	157,00 €	8AA0070054	Z-GLD-HM-And-7	8AA	157,00 €	8AA0070052	Z-GLD-HM-ZM-7	8AA	234,00 €
8AA0080051	Z-GLD-HM-H7-8	8AA	180,00 €	8AA0080054	Z-GLD-HM-And-8	8AA	180,00 €	8AA0080052	Z-GLD-HM-ZM-8	8AA	265,00 €
8AA0090051	Z-GLD-HM-H7-9	8AA	204,00 €	8AA0090054	Z-GLD-HM-And-9	8AA	204,00 €	8AA0090052	Z-GLD-HM-ZM-9	8AA	291,00 €
8AA0100051	Z-GLD-HM-H7-10	8AA	224,00 €	8AA0100054	Z-GLD-HM-And-10	8AA	224,00 €	8AA0100052	Z-GLD-HM-ZM-10	8AA	318,00 €
8AA0110051	Z-GLD-HM-H7-11	8AA	245,00 €	8AA0110054	Z-GLD-HM-And-11	8AA	245,00 €	8AA0110052	Z-GLD-HM-ZM-11	8AA	331,00 €
8AA0120051	Z-GLD-HM-H7-12	8AA	255,00 €	8AA0120054	Z-GLD-HM-And-12	8AA	255,00 €	8AA0120052	Z-GLD-HM-ZM-12	8AA	342,00 €
8AA0130051	Z-GLD-HM-H7-13	8AA	263,00 €	8AA0130054	Z-GLD-HM-And-13	8AA	263,00 €	8AA0130052	Z-GLD-HM-ZM-13	8AA	358,00 €
8AA0140051	Z-GLD-HM-H7-14	8AA	275,00 €	8AA0140054	Z-GLD-HM-And-14	8AA	275,00 €	8AA0140052	Z-GLD-HM-ZM-14	8AA	369,00 €
8AA0150051	Z-GLD-HM-H7-15	8AA	284,00 €	8AA0150054	Z-GLD-HM-And-15	8AA	284,00 €	8AA0150052	Z-GLD-HM-ZM-15	8AA	381,00 €
8AA0160051	Z-GLD-HM-H7-16	8AA	293,00 €	8AA0160054	Z-GLD-HM-And-16	8AA	293,00 €	8AA0160052	Z-GLD-HM-ZM-16	8AA	394,00 €
8AA0170051	Z-GLD-HM-H7-17	8AA	303,00 €	8AA0170054	Z-GLD-HM-And-17	8AA	303,00 €	8AA0170052	Z-GLD-HM-ZM-17	8AA	407,00 €
8AA0180051	Z-GLD-HM-H7-18	8AA	313,00 €	8AA0180054	Z-GLD-HM-And-18	8AA	313,00 €	8AA0180052	Z-GLD-HM-ZM-18	8AA	432,00 €
8AA0190051	Z-GLD-HM-H7-19	8AA	332,00 €	8AA0190054	Z-GLD-HM-And-19	8AA	332,00 €	8AA0190052	Z-GLD-HM-ZM-19	8AA	445,00 €
8AA0200051	Z-GLD-HM-H7-20	8AA	342,00 €	8AA0200054	Z-GLD-HM-And-20	8AA	342,00 €	8AA0200052	Z-GLD-HM-ZM-20	8AA	462,00 €
8AA0210051	Z-GLD-HM-H7-21	8AA	356,00 €	8AA0210054	Z-GLD-HM-And-21	8AA	356,00 €	8AA0210052	Z-GLD-HM-ZM-21	8AA	481,00 €
8AA0220051	Z-GLD-HM-H7-22	8AA	370,00 €	8AA0220054	Z-GLD-HM-And-22	8AA	370,00 €	8AA0220052	Z-GLD-HM-ZM-22	8AA	498,00 €
8AA0230051	Z-GLD-HM-H7-23	8AA	384,00 €	8AA0230054	Z-GLD-HM-And-23	8AA	384,00 €	8AA0230052	Z-GLD-HM-ZM-23	8AA	514,00 €
8AA0240051	Z-GLD-HM-H7-24	8AA	395,00 €	8AA0240054	Z-GLD-HM-And-24	8AA	395,00 €	8AA0240052	Z-GLD-HM-ZM-24	8AA	607,00 €
8AA0250051	Z-GLD-HM-H7-25	8AA	467,00 €	8AA0250054	Z-GLD-HM-And-25	8AA	467,00 €	8AA0250052	Z-GLD-HM-ZM-25	8AA	626,00 €
8AA0260051	Z-GLD-HM-H7-26	8AA	481,00 €	8AA0260054	Z-GLD-HM-And-26	8AA	481,00 €	8AA0260052	Z-GLD-HM-ZM-26	8AA	646,00 €
8AA0270051	Z-GLD-HM-H7-27	8AA	497,00 €	8AA0270054	Z-GLD-HM-And-27	8AA	497,00 €	8AA0270052	Z-GLD-HM-ZM-27	8AA	666,00 €
8AA0280051	Z-GLD-HM-H7-28	8AA	512,00 €	8AA0280054	Z-GLD-HM-And-28	8AA	512,00 €	8AA0280052	Z-GLD-HM-ZM-28	8AA	709,00 €
8AA0300051	Z-GLD-HM-H7-30	8AA	546,00 €	8AA0300054	Z-GLD-HM-And-30	8AA	546,00 €	8AA0300052	Z-GLD-HM-ZM-30	8AA	745,00 €
8AA0320051	Z-GLD-HM-H7-32	8AA	573,00 €	8AA0320054	Z-GLD-HM-And-32	8AA	573,00 €	8AA0320052	Z-GLD-HM-ZM-32	8AA	764,00 €
8AA0330051	Z-GLD-HM-H7-33	8AA	588,00 €	8AA0330054	Z-GLD-HM-And-33	8AA	588,00 €	8AA0330052	Z-GLD-HM-ZM-33	8AA	787,00 €
8AA0340051	Z-GLD-HM-H7-34	8AA	606,00 €	8AA0340054	Z-GLD-HM-And-34	8AA	606,00 €	8AA0340052	Z-GLD-HM-ZM-34	8AA	812,00 €

ANr.	Beschreibung	AGr.	Einzelpreis	ANr.	Beschreibung	AGr.	Einzelpreis	ANr.	Beschreibung	AGr.	Einzelpreis
<b>Grenzlehrdorne, HM, ohne ZM, Passung H7</b>				<b>Grenzlehrdorne, HM, ohne ZM, andere Passungen</b>				<b>Grenzlehrdorne, HM, mit ZM</b>			
8AA0350051	Z-GLD-HM-H7-35	8AA	625,00 €	8AA0350054	Z-GLD-HM-And-35	8AA	625,00 €	8AA0350052	Z-GLD-HM-ZM-35	8AA	837,00 €
8AA0360051	Z-GLD-HM-H7-36	8AA	644,00 €	8AA0360054	Z-GLD-HM-And-36	8AA	644,00 €	8AA0360052	Z-GLD-HM-ZM-36	8AA	863,00 €
8AA0370051	Z-GLD-HM-H7-37	8AA	664,00 €	8AA0370054	Z-GLD-HM-And-37	8AA	664,00 €	8AA0370052	Z-GLD-HM-ZM-37	8AA	888,00 €
8AA0380051	Z-GLD-HM-H7-38	8AA	683,00 €	8AA0380054	Z-GLD-HM-And-38	8AA	683,00 €	8AA0380052	Z-GLD-HM-ZM-38	8AA	924,00 €
8AA0400051	Z-GLD-HM-H7-40	8AA	711,00 €	8AA0400054	Z-GLD-HM-And-40	8AA	711,00 €	8AA0400052	Z-GLD-HM-ZM-40	8AA	958,00 €
8AA0420051	Z-GLD-HM-H7-42	8AA	737,00 €	8AA0420054	Z-GLD-HM-And-42	8AA	737,00 €	8AA0420052	Z-GLD-HM-ZM-42	8AA	998,00 €
8AA0440051	Z-GLD-HM-H7-44	8AA	768,00 €	8AA0440054	Z-GLD-HM-And-44	8AA	768,00 €	8AA0440052	Z-GLD-HM-ZM-44	8AA	1.023,00 €
8AA0450051	Z-GLD-HM-H7-45	8AA	787,00 €	8AA0450054	Z-GLD-HM-And-45	8AA	787,00 €	8AA0450052	Z-GLD-HM-ZM-45	8AA	1.045,00 €
8AA0460051	Z-GLD-HM-H7-46	8AA	804,00 €	8AA0460054	Z-GLD-HM-And-46	8AA	804,00 €	8AA0460052	Z-GLD-HM-ZM-46	8AA	1.069,00 €
8AA0470051	Z-GLD-HM-H7-47	8AA	822,00 €	8AA0470054	Z-GLD-HM-And-47	8AA	822,00 €	8AA0470052	Z-GLD-HM-ZM-47	8AA	1.091,00 €
8AA0480051	Z-GLD-HM-H7-48	8AA	839,00 €	8AA0480054	Z-GLD-HM-And-48	8AA	839,00 €	8AA0480052	Z-GLD-HM-ZM-48	8AA	1.141,00 €
8AA0500051	Z-GLD-HM-H7-50	8AA	878,00 €	8AA0500054	Z-GLD-HM-And-50	8AA	878,00 €	8AA0500052	Z-GLD-HM-ZM-50	8AA	1.190,00 €

ANr.	Beschreibung	AGr.	Einzelpreis	ANr.	Beschreibung	AGr.	Einzelpreis	ANr.	Beschreibung	AGr.	Einzelpreis
------	--------------	------	-------------	------	--------------	------	-------------	------	--------------	------	-------------

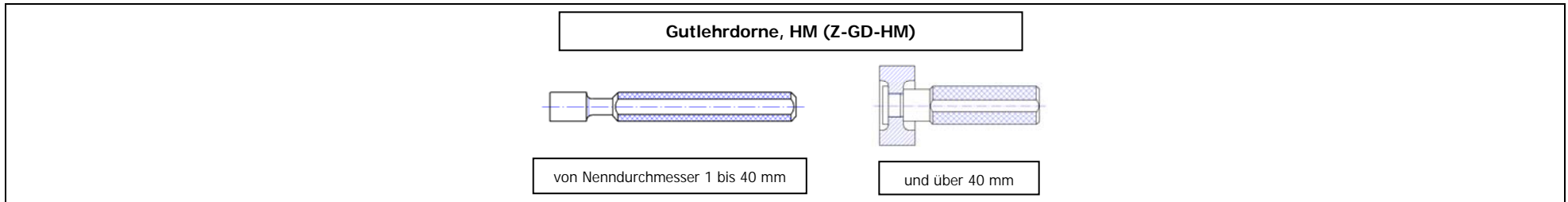

Gutlehdorne, HM, ohne ZM, Passung H7				Gutlehdorne, HM, ohne ZM, andere Passungen				Gutlehdorne, HM, mit ZM			
8AB0000000	Z-GD-HM-H7-2	8AB	70,00 €	8AB0000000	Z-GD-HM-And-2	8AB	70,00 €	8AB0000000	Z-GD-HM-ZM-2	8AB	94,00 €
8AB0000000	Z-GD-HM-H7-3	8AB	72,00 €	8AB0000000	Z-GD-HM-And-3	8AB	72,00 €	8AB0000000	Z-GD-HM-ZM-3	8AB	101,00 €
8AB0000000	Z-GD-HM-H7-4	8AB	77,00 €	8AB0000000	Z-GD-HM-And-4	8AB	77,00 €	8AB0000000	Z-GD-HM-ZM-4	8AB	107,00 €
8AB0000000	Z-GD-HM-H7-5	8AB	83,00 €	8AB0000000	Z-GD-HM-And-5	8AB	83,00 €	8AB0000000	Z-GD-HM-ZM-5	8AB	114,00 €
8AB0000000	Z-GD-HM-H7-6	8AB	88,00 €	8AB0000000	Z-GD-HM-And-6	8AB	88,00 €	8AB0000000	Z-GD-HM-ZM-6	8AB	122,00 €
8AB0000000	Z-GD-HM-H7-7	8AB	94,00 €	8AB0000000	Z-GD-HM-And-7	8AB	94,00 €	8AB0000000	Z-GD-HM-ZM-7	8AB	140,00 €
8AB0000000	Z-GD-HM-H7-8	8AB	108,00 €	8AB0000000	Z-GD-HM-And-8	8AB	108,00 €	8AB0000000	Z-GD-HM-ZM-8	8AB	159,00 €
8AB0000000	Z-GD-HM-H7-9	8AB	122,00 €	8AB0000000	Z-GD-HM-And-9	8AB	122,00 €	8AB0000000	Z-GD-HM-ZM-9	8AB	175,00 €
8AB0000000	Z-GD-HM-H7-10	8AB	134,00 €	8AB0000000	Z-GD-HM-And-10	8AB	134,00 €	8AB0000000	Z-GD-HM-ZM-10	8AB	191,00 €
8AB0000000	Z-GD-HM-H7-11	8AB	147,00 €	8AB0000000	Z-GD-HM-And-11	8AB	147,00 €	8AB0000000	Z-GD-HM-ZM-11	8AB	199,00 €
8AB0000000	Z-GD-HM-H7-12	8AB	153,00 €	8AB0000000	Z-GD-HM-And-12	8AB	153,00 €	8AB0000000	Z-GD-HM-ZM-12	8AB	205,00 €
8AB0000000	Z-GD-HM-H7-13	8AB	158,00 €	8AB0000000	Z-GD-HM-And-13	8AB	158,00 €	8AB0000000	Z-GD-HM-ZM-13	8AB	215,00 €
8AB0000000	Z-GD-HM-H7-14	8AB	165,00 €	8AB0000000	Z-GD-HM-And-14	8AB	165,00 €	8AB0000000	Z-GD-HM-ZM-14	8AB	221,00 €
8AB0000000	Z-GD-HM-H7-15	8AB	170,00 €	8AB0000000	Z-GD-HM-And-15	8AB	170,00 €	8AB0000000	Z-GD-HM-ZM-15	8AB	229,00 €
8AB0000000	Z-GD-HM-H7-16	8AB	176,00 €	8AB0000000	Z-GD-HM-And-16	8AB	176,00 €	8AB0000000	Z-GD-HM-ZM-16	8AB	236,00 €
8AB0000000	Z-GD-HM-H7-17	8AB	182,00 €	8AB0000000	Z-GD-HM-And-17	8AB	182,00 €	8AB0000000	Z-GD-HM-ZM-17	8AB	244,00 €
8AB0000000	Z-GD-HM-H7-18	8AB	188,00 €	8AB0000000	Z-GD-HM-And-18	8AB	188,00 €	8AB0000000	Z-GD-HM-ZM-18	8AB	259,00 €
8AB0000000	Z-GD-HM-H7-19	8AB	199,00 €	8AB0000000	Z-GD-HM-And-19	8AB	199,00 €	8AB0000000	Z-GD-HM-ZM-19	8AB	267,00 €
8AB0000000	Z-GD-HM-H7-20	8AB	205,00 €	8AB0000000	Z-GD-HM-And-20	8AB	205,00 €	8AB0000000	Z-GD-HM-ZM-20	8AB	277,00 €
8AB0000000	Z-GD-HM-H7-21	8AB	214,00 €	8AB0000000	Z-GD-HM-And-21	8AB	214,00 €	8AB0000000	Z-GD-HM-ZM-21	8AB	289,00 €
8AB0000000	Z-GD-HM-H7-22	8AB	222,00 €	8AB0000000	Z-GD-HM-And-22	8AB	222,00 €	8AB0000000	Z-GD-HM-ZM-22	8AB	299,00 €
8AB0000000	Z-GD-HM-H7-23	8AB	230,00 €	8AB0000000	Z-GD-HM-And-23	8AB	230,00 €	8AB0000000	Z-GD-HM-ZM-23	8AB	308,00 €
8AB0000000	Z-GD-HM-H7-24	8AB	237,00 €	8AB0000000	Z-GD-HM-And-24	8AB	237,00 €	8AB0000000	Z-GD-HM-ZM-24	8AB	364,00 €
8AB0000000	Z-GD-HM-H7-25	8AB	280,00 €	8AB0000000	Z-GD-HM-And-25	8AB	280,00 €	8AB0000000	Z-GD-HM-ZM-25	8AB	376,00 €
8AB0000000	Z-GD-HM-H7-26	8AB	289,00 €	8AB0000000	Z-GD-HM-And-26	8AB	289,00 €	8AB0000000	Z-GD-HM-ZM-26	8AB	388,00 €
8AB0000000	Z-GD-HM-H7-27	8AB	298,00 €	8AB0000000	Z-GD-HM-And-27	8AB	298,00 €	8AB0000000	Z-GD-HM-ZM-27	8AB	400,00 €
8AB0000000	Z-GD-HM-H7-28	8AB	307,00 €	8AB0000000	Z-GD-HM-And-28	8AB	307,00 €	8AB0000000	Z-GD-HM-ZM-28	8AB	425,00 €
8AB0000000	Z-GD-HM-H7-30	8AB	328,00 €	8AB0000000	Z-GD-HM-And-30	8AB	328,00 €	8AB0000000	Z-GD-HM-ZM-30	8AB	447,00 €
8AB0000000	Z-GD-HM-H7-32	8AB	344,00 €	8AB0000000	Z-GD-HM-And-32	8AB	344,00 €	8AB0000000	Z-GD-HM-ZM-32	8AB	458,00 €
8AB0000000	Z-GD-HM-H7-33	8AB	353,00 €	8AB0000000	Z-GD-HM-And-33	8AB	353,00 €	8AB0000000	Z-GD-HM-ZM-33	8AB	472,00 €
8AB0000000	Z-GD-HM-H7-34	8AB	364,00 €	8AB0000000	Z-GD-HM-And-34	8AB	364,00 €	8AB0000000	Z-GD-HM-ZM-3	8AB	487,00 €
8AB0000000	Z-GD-HM-H7-35	8AB	375,00 €	8AB0000000	Z-GD-HM-And-35	8AB	375,00 €	8AB0000000	Z-GD-HM-ZM-35	8AB	502,00 €
8AB0000000	Z-GD-HM-H7-36	8AB	386,00 €	8AB0000000	Z-GD-HM-And-36	8AB	386,00 €	8AB0000000	Z-GD-HM-ZM-36	8AB	518,00 €

ANr.	Beschreibung	AGr.	Einzelpreis	ANr.	Beschreibung	AGr.	Einzelpreis	ANr.	Beschreibung	AGr.	Einzelpreis
<b>Gutlehrdorne, HM, ohne ZM, Passung H7</b>			<b>Gutlehrdorne, HM, ohne ZM, andere Passungen</b>			<b>Gutlehrdorne, HM, mit ZM</b>					
8AB0000000	Z-GD-HM-H7-37	8AB	398,00 €	8AB0000000	Z-GD-HM-And-37	8AB	398,00 €	8AB0000000	Z-GD-HM-ZM-37	8AB	533,00 €
8AB0000000	Z-GD-HM-H7-38	8AB	410,00 €	8AB0000000	Z-GD-HM-And-38	8AB	410,00 €	8AB0000000	Z-GD-HM-ZM-38	8AB	554,00 €
8AB0000000	Z-GD-HM-H7-40	8AB	427,00 €	8AB0000000	Z-GD-HM-And-40	8AB	427,00 €	8AB0000000	Z-GD-HM-ZM-40	8AB	575,00 €
8AB0000000	Z-GD-HM-H7-42	8AB	442,00 €	8AB0000000	Z-GD-HM-And-42	8AB	442,00 €	8AB0000000	Z-GD-HM-ZM-42	8AB	599,00 €
8AB0000000	Z-GD-HM-H7-44	8AB	461,00 €	8AB0000000	Z-GD-HM-And-44	8AB	461,00 €	8AB0000000	Z-GD-HM-ZM-44	8AB	614,00 €
8AB0000000	Z-GD-HM-H7-45	8AB	472,00 €	8AB0000000	Z-GD-HM-And-45	8AB	472,00 €	8AB0000000	Z-GD-HM-ZM-45	8AB	627,00 €
8AB0000000	Z-GD-HM-H7-46	8AB	482,00 €	8AB0000000	Z-GD-HM-And-46	8AB	482,00 €	8AB0000000	Z-GD-HM-ZM-46	8AB	641,00 €
8AB0000000	Z-GD-HM-H7-47	8AB	493,00 €	8AB0000000	Z-GD-HM-And-47	8AB	493,00 €	8AB0000000	Z-GD-HM-ZM-47	8AB	655,00 €
8AB0000000	Z-GD-HM-H7-48	8AB	503,00 €	8AB0000000	Z-GD-HM-And-48	8AB	503,00 €	8AB0000000	Z-GD-HM-ZM-48	8AB	685,00 €
8AB0000000	Z-GD-HM-H7-50	8AB	527,00 €	8AB0000000	Z-GD-HM-And-50	8AB	527,00 €	8AB0000000	Z-GD-HM-ZM-50	8AB	730,00 €



ANr.	Beschreibung	AGr.	Einzelpreis	ANr.	Beschreibung	AGr.	Einzelpreis	ANr.	Beschreibung	AGr.	Einzelpreis
------	--------------	------	-------------	------	--------------	------	-------------	------	--------------	------	-------------

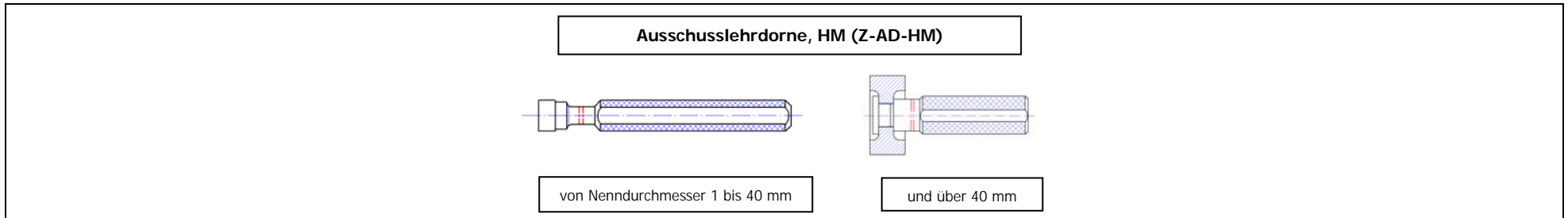

Ausschusslehrdorne, HM, ohne ZM, Passung H7				Ausschusslehrdorne, HM, ohne ZM, andere Passungen				Ausschusslehrdorne, HM, mit ZM			
8AC0000000	Z-AD-HM-H7-2	8AB	70,00 €	8AC0000000	Z-AD-HM-And-2	8AB	70,00 €	8AC0000000	Z-AD-HM-ZM-2	8AB	94,00 €
8AC0000000	Z-AD-HM-H7-3	8AB	72,00 €	8AC0000000	Z-AD-HM-And-3	8AB	72,00 €	8AC0000000	Z-AD-HM-ZM-3	8AB	101,00 €
8AC0000000	Z-AD-HM-H7-4	8AB	77,00 €	8AC0000000	Z-AD-HM-And-4	8AB	77,00 €	8AC0000000	Z-AD-HM-ZM-4	8AB	107,00 €
8AC0000000	Z-AD-HM-H7-5	8AB	83,00 €	8AC0000000	Z-AD-HM-And-5	8AB	83,00 €	8AC0000000	Z-AD-HM-ZM-5	8AB	114,00 €
8AC0000000	Z-AD-HM-H7-6	8AB	88,00 €	8AC0000000	Z-AD-HM-And-6	8AB	88,00 €	8AC0000000	Z-AD-HM-ZM-6	8AB	122,00 €
8AC0000000	Z-AD-HM-H7-7	8AB	94,00 €	8AC0000000	Z-AD-HM-And-7	8AB	94,00 €	8AC0000000	Z-AD-HM-ZM-7	8AB	140,00 €
8AC0000000	Z-AD-HM-H7-8	8AB	108,00 €	8AC0000000	Z-AD-HM-And-8	8AB	108,00 €	8AC0000000	Z-AD-HM-ZM-8	8AB	159,00 €
8AC0000000	Z-AD-HM-H7-9	8AB	122,00 €	8AC0000000	Z-AD-HM-And-9	8AB	122,00 €	8AC0000000	Z-AD-HM-ZM-9	8AB	175,00 €
8AC0000000	Z-AD-HM-H7-10	8AB	134,00 €	8AC0000000	Z-AD-HM-And-10	8AB	134,00 €	8AC0000000	Z-AD-HM-ZM-10	8AB	191,00 €
8AC0000000	Z-AD-HM-H7-11	8AB	147,00 €	8AC0000000	Z-AD-HM-And-11	8AB	147,00 €	8AC0000000	Z-AD-HM-ZM-11	8AB	199,00 €
8AC0000000	Z-AD-HM-H7-12	8AB	153,00 €	8AC0000000	Z-AD-HM-And-12	8AB	153,00 €	8AC0000000	Z-AD-HM-ZM-12	8AB	205,00 €
8AC0000000	Z-AD-HM-H7-13	8AB	158,00 €	8AC0000000	Z-AD-HM-And-13	8AB	158,00 €	8AC0000000	Z-AD-HM-ZM-13	8AB	215,00 €
8AC0000000	Z-AD-HM-H7-14	8AB	165,00 €	8AC0000000	Z-AD-HM-And-14	8AB	165,00 €	8AC0000000	Z-AD-HM-ZM-14	8AB	221,00 €
8AC0000000	Z-AD-HM-H7-15	8AB	170,00 €	8AC0000000	Z-AD-HM-And-15	8AB	170,00 €	8AC0000000	Z-AD-HM-ZM-15	8AB	229,00 €
8AC0000000	Z-AD-HM-H7-16	8AB	176,00 €	8AC0000000	Z-AD-HM-And-16	8AB	176,00 €	8AC0000000	Z-AD-HM-ZM-16	8AB	236,00 €
8AC0000000	Z-AD-HM-H7-17	8AB	182,00 €	8AC0000000	Z-AD-HM-And-17	8AB	182,00 €	8AC0000000	Z-AD-HM-ZM-17	8AB	244,00 €
8AC0000000	Z-AD-HM-H7-18	8AB	188,00 €	8AC0000000	Z-AD-HM-And-18	8AB	188,00 €	8AC0000000	Z-AD-HM-ZM-18	8AB	259,00 €
8AC0000000	Z-AD-HM-H7-19	8AB	199,00 €	8AC0000000	Z-AD-HM-And-19	8AB	199,00 €	8AC0000000	Z-AD-HM-ZM-19	8AB	267,00 €
8AC0000000	Z-AD-HM-H7-20	8AB	205,00 €	8AC0000000	Z-AD-HM-And-20	8AB	205,00 €	8AC0000000	Z-AD-HM-ZM-20	8AB	277,00 €
8AC0000000	Z-AD-HM-H7-21	8AB	214,00 €	8AC0000000	Z-AD-HM-And-21	8AB	214,00 €	8AC0000000	Z-AD-HM-ZM-21	8AB	289,00 €
8AC0000000	Z-AD-HM-H7-22	8AB	222,00 €	8AC0000000	Z-AD-HM-And-22	8AB	222,00 €	8AC0000000	Z-AD-HM-ZM-22	8AB	299,00 €
8AC0000000	Z-AD-HM-H7-23	8AB	230,00 €	8AC0000000	Z-AD-HM-And-23	8AB	230,00 €	8AC0000000	Z-AD-HM-ZM-23	8AB	308,00 €
8AC0000000	Z-AD-HM-H7-24	8AB	237,00 €	8AC0000000	Z-AD-HM-And-24	8AB	237,00 €	8AC0000000	Z-AD-HM-ZM-24	8AB	364,00 €
8AC0000000	Z-AD-HM-H7-25	8AB	280,00 €	8AC0000000	Z-AD-HM-And-25	8AB	280,00 €	8AC0000000	Z-AD-HM-ZM-25	8AB	376,00 €
8AC0000000	Z-AD-HM-H7-26	8AB	289,00 €	8AC0000000	Z-AD-HM-And-26	8AB	289,00 €	8AC0000000	Z-AD-HM-ZM-26	8AB	388,00 €
8AC0000000	Z-AD-HM-H7-27	8AB	298,00 €	8AC0000000	Z-AD-HM-And-27	8AB	298,00 €	8AC0000000	Z-AD-HM-ZM-27	8AB	400,00 €
8AC0000000	Z-AD-HM-H7-28	8AB	307,00 €	8AC0000000	Z-AD-HM-And-28	8AB	307,00 €	8AC0000000	Z-AD-HM-ZM-28	8AB	425,00 €
8AC0000000	Z-AD-HM-H7-30	8AB	328,00 €	8AC0000000	Z-AD-HM-And-30	8AB	328,00 €	8AC0000000	Z-AD-HM-ZM-30	8AB	447,00 €
8AC0000000	Z-AD-HM-H7-32	8AB	344,00 €	8AC0000000	Z-AD-HM-And-32	8AB	344,00 €	8AC0000000	Z-AD-HM-ZM-32	8AB	458,00 €
8AC0000000	Z-AD-HM-H7-33	8AB	353,00 €	8AC0000000	Z-AD-HM-And-33	8AB	353,00 €	8AC0000000	Z-AD-HM-ZM-33	8AB	472,00 €
8AC0000000	Z-AD-HM-H7-34	8AB	364,00 €	8AC0000000	Z-AD-HM-And-34	8AB	364,00 €	8AC0000000	Z-AD-HM-ZM-34	8AB	487,00 €
8AC0000000	Z-AD-HM-H7-35	8AB	375,00 €	8AC0000000	Z-AD-HM-And-35	8AB	375,00 €	8AC0000000	Z-AD-HM-ZM-35	8AB	502,00 €

ANr.	Beschreibung	AGr.	Einzelpreis	ANr.	Beschreibung	AGr.	Einzelpreis	ANr.	Beschreibung	AGr.	Einzelpreis
<b>Ausschusslehrdorne, HM, ohne ZM, Passung H7</b>				<b>Ausschusslehrdorne, HM, ohne ZM, andere Passungen</b>				<b>Ausschusslehrdorne, HM, mit ZM</b>			
8AC0000000	<b>Z-AD-HM-H7-36</b>	8AB	<b>386,00 €</b>	8AC0000000	<b>Z-AD-HM-And-36</b>	8AB	<b>386,00 €</b>	8AC0000000	<b>Z-AD-HM-ZM-36</b>	8AB	<b>518,00 €</b>
8AC0000000	<b>Z-AD-HM-H7-37</b>	8AB	<b>398,00 €</b>	8AC0000000	<b>Z-AD-HM-And-37</b>	8AB	<b>398,00 €</b>	8AC0000000	<b>Z-AD-HM-ZM-37</b>	8AB	<b>533,00 €</b>
8AC0000000	<b>Z-AD-HM-H7-38</b>	8AB	<b>410,00 €</b>	8AC0000000	<b>Z-AD-HM-And-38</b>	8AB	<b>410,00 €</b>	8AC0000000	<b>Z-AD-HM-ZM-38</b>	8AB	<b>554,00 €</b>
8AC0000000	<b>Z-AD-HM-H7-40</b>	8AB	<b>427,00 €</b>	8AC0000000	<b>Z-AD-HM-And-40</b>	8AB	<b>427,00 €</b>	8AC0000000	<b>Z-AD-HM-ZM-40</b>	8AB	<b>575,00 €</b>
8AC0000000	<b>Z-AD-HM-H7-42</b>	8AB	<b>442,00 €</b>	8AC0000000	<b>Z-AD-HM-And-42</b>	8AB	<b>442,00 €</b>	8AC0000000	<b>Z-AD-HM-ZM-42</b>	8AB	<b>599,00 €</b>
8AC0000000	<b>Z-AD-HM-H7-44</b>	8AB	<b>461,00 €</b>	8AC0000000	<b>Z-AD-HM-And-44</b>	8AB	<b>461,00 €</b>	8AC0000000	<b>Z-AD-HM-ZM-44</b>	8AB	<b>614,00 €</b>
8AC0000000	<b>Z-AD-HM-H7-45</b>	8AB	<b>472,00 €</b>	8AC0000000	<b>Z-AD-HM-And-45</b>	8AB	<b>472,00 €</b>	8AC0000000	<b>Z-AD-HM-ZM-45</b>	8AB	<b>627,00 €</b>
8AC0000000	<b>Z-AD-HM-H7-46</b>	8AB	<b>482,00 €</b>	8AC0000000	<b>Z-AD-HM-And-46</b>	8AB	<b>482,00 €</b>	8AC0000000	<b>Z-AD-HM-ZM-46</b>	8AB	<b>641,00 €</b>
8AC0000000	<b>Z-AD-HM-H7-47</b>	8AB	<b>493,00 €</b>	8AC0000000	<b>Z-AD-HM-And-47</b>	8AB	<b>493,00 €</b>	8AC0000000	<b>Z-AD-HM-ZM-47</b>	8AB	<b>655,00 €</b>
8AC0000000	<b>Z-AD-HM-H7-48</b>	8AB	<b>503,00 €</b>	8AC0000000	<b>Z-AD-HM-And-48</b>	8AB	<b>503,00 €</b>	8AC0000000	<b>Z-AD-HM-ZM-48</b>	8AB	<b>685,00 €</b>
8AC0000000	<b>Z-AD-HM-H7-50</b>	8AB	<b>527,00 €</b>	8AC0000000	<b>Z-AD-HM-And-50</b>	8AB	<b>527,00 €</b>	8AC0000000	<b>Z-AD-HM-ZM-50</b>	8AB	<b>730,00 €</b>

ANr.	Beschreibung	AGr.	Einzelpreis	ANr.	Beschreibung	AGr.	Einzelpreis
------	--------------	------	-------------	------	--------------	------	-------------

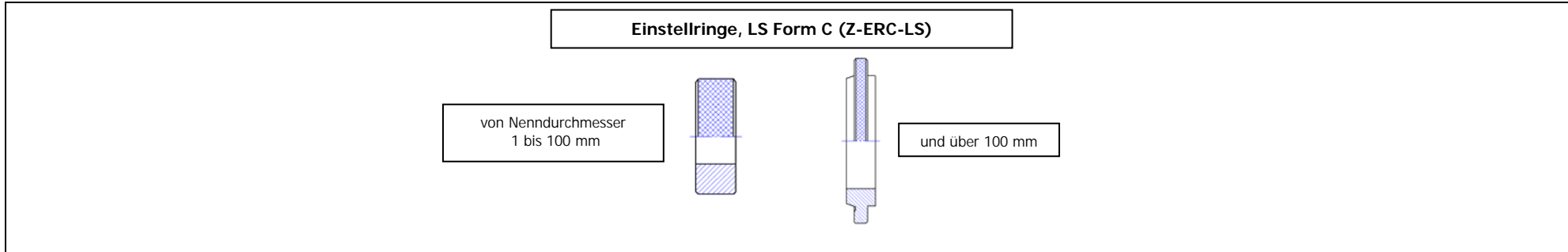

Einstellringe DIN 2250, Form C, ohne ZM				Einstellringe DIN 2250, Form C, mit ZM			
8AD0010013	Z-ERC-LS-OZ-1	8AD	107,00 €	8AD0010012	Z-ERC-LS-ZM-1	8AD	218,00 €
8AD0012013	Z-ERC-LS-OZ-1,2	8AD	105,00 €	8AD0012012	Z-ERC-LS-ZM-1,2	8AD	218,00 €
8AD0015013	Z-ERC-LS-OZ-1,5	8AD	104,00 €	8AD0015012	Z-ERC-LS-ZM-1,5	8AD	218,00 €
8AD0018013	Z-ERC-LS-OZ-1,8	8AD	103,00 €	8AD0018012	Z-ERC-LS-ZM-1,8	8AD	218,00 €
8AD0020013	Z-ERC-LS-OZ-2	8AD	102,00 €	8AD0020012	Z-ERC-LS-ZM-2	8AD	186,00 €
8AD0022013	Z-ERC-LS-OZ-2,2	8AD	98,00 €	8AD0022012	Z-ERC-LS-ZM-2,2	8AD	194,00 €
8AD0025013	Z-ERC-LS-OZ-2,5	8AD	96,00 €	8AD0025012	Z-ERC-LS-ZM-2,5	8AD	197,00 €
8AD0028013	Z-ERC-LS-OZ-2,8	8AD	93,00 €	8AD0028012	Z-ERC-LS-ZM-2,8	8AD	197,00 €
8AD0030013	Z-ERC-LS-OZ-3	8ADL	70,00 €	8AD0030012	Z-ERC-LS-ZM-3	8AD	81,00 €
8AD0035013	Z-ERC-LS-OZ-3,5	8ADL	46,00 €	8AD0035012	Z-ERC-LS-ZM-3,5	8AD	81,00 €
8AD0040013	Z-ERC-LS-OZ-4	8ADL	45,00 €	8AD0040012	Z-ERC-LS-ZM-4	8AD	80,00 €
8AD0045013	Z-ERC-LS-OZ-4,5	8ADL	45,00 €	8AD0045012	Z-ERC-LS-ZM-4,5	8AD	80,00 €
8AD0050013	Z-ERC-LS-OZ-5	8ADL	44,00 €	8AD0050012	Z-ERC-LS-ZM-5	8AD	78,00 €
8AD0060013	Z-ERC-LS-OZ-6	8ADL	43,00 €	8AD0060012	Z-ERC-LS-ZM-6	8AD	77,00 €
8AD0070013	Z-ERC-LS-OZ-7	8ADL	43,00 €	8AD0070012	Z-ERC-LS-ZM-7	8AD	77,00 €
8AD0080013	Z-ERC-LS-OZ-8	8ADL	43,00 €	8AD0080012	Z-ERC-LS-ZM-8	8AD	77,00 €
8AD0090013	Z-ERC-LS-OZ-9	8ADL	43,00 €	8AD0090012	Z-ERC-LS-ZM-9	8AD	77,00 €
8AD0100013	Z-ERC-LS-OZ-10	8ADL	43,00 €	8AD0100012	Z-ERC-LS-ZM-10	8AD	77,00 €
8AD0110013	Z-ERC-LS-OZ-11	8ADL	44,00 €	8AD0110012	Z-ERC-LS-ZM-11	8AD	78,00 €
8AD0120013	Z-ERC-LS-OZ-12	8ADL	45,00 €	8AD0120012	Z-ERC-LS-ZM-12	8AD	81,00 €
8AD0130013	Z-ERC-LS-OZ-13	8ADL	46,00 €	8AD0130012	Z-ERC-LS-ZM-13	8AD	81,00 €
8AD0140013	Z-ERC-LS-OZ-14	8ADL	46,00 €	8AD0140012	Z-ERC-LS-ZM-14	8AD	81,00 €
8AD0150013	Z-ERC-LS-OZ-15	8ADL	47,00 €	8AD0150012	Z-ERC-LS-ZM-15	8AD	83,00 €
8AD0160013	Z-ERC-LS-OZ-16	8ADL	48,00 €	8AD0160012	Z-ERC-LS-ZM-16	8AD	84,00 €
8AD0170013	Z-ERC-LS-OZ-17	8ADL	49,00 €	8AD0170012	Z-ERC-LS-ZM-17	8AD	86,00 €
8AD0180013	Z-ERC-LS-OZ-18	8ADL	49,00 €	8AD0180012	Z-ERC-LS-ZM-18	8AD	86,00 €
8AD0190013	Z-ERC-LS-OZ-19	8ADL	50,00 €	8AD0190012	Z-ERC-LS-ZM-19	8AD	88,00 €
8AD0200013	Z-ERC-LS-OZ-20	8ADL	51,00 €	8AD0200012	Z-ERC-LS-ZM-20	8AD	89,00 €
8AD0210013	Z-ERC-LS-OZ-21	8AD	61,00 €	8AD0210012	Z-ERC-LS-ZM-21	8AD	89,00 €
8AD0220013	Z-ERC-LS-OZ-22	8ADL	52,00 €	8AD0220012	Z-ERC-LS-ZM-22	8AD	91,00 €

ANr.	Beschreibung	AGr.	Einzelpreis	ANr.	Beschreibung	AGr.	Einzelpreis
<b>Einstellringe DIN 2250, Form C, ohne ZM</b>				<b>Einstellringe DIN 2250, Form C, mit ZM</b>			
8AD0230013	Z-ERC-LS-OZ-23	8AD	62,00 €	8AD0230012	Z-ERC-LS-ZM-23	8AD	93,00 €
8AD0240013	Z-ERC-LS-OZ-24	8ADL	53,00 €	8AD0240012	Z-ERC-LS-ZM-24	8AD	94,00 €
8AD0250013	Z-ERC-LS-OZ-25	8ADL	55,00 €	8AD0250012	Z-ERC-LS-ZM-25	8AD	96,00 €
8AD0260013	Z-ERC-LS-OZ-26	8ADL	56,00 €	8AD0260012	Z-ERC-LS-ZM-26	8AD	97,00 €
8AD0270013	Z-ERC-LS-OZ-27	8AD	65,00 €	8AD0270012	Z-ERC-LS-ZM-27	8AD	97,00 €
8AD0280013	Z-ERC-LS-OZ-28	8ADL	56,00 €	8AD0280012	Z-ERC-LS-ZM-28	8AD	97,00 €
8AD0290013	Z-ERC-LS-OZ-29	8AD	68,00 €	8AD0290012	Z-ERC-LS-ZM-29	8AD	102,00 €
8AD0300013	Z-ERC-LS-OZ-30	8ADL	58,00 €	8AD0300012	Z-ERC-LS-ZM-30	8AD	102,00 €
8AD0310013	Z-ERC-LS-OZ-31	8AD	69,00 €	8AD0310012	Z-ERC-LS-ZM-31	8AD	104,00 €
8AD0320013	Z-ERC-LS-OZ-32	8ADL	59,00 €	8AD0320012	Z-ERC-LS-ZM-32	8AD	104,00 €
8AD0330013	Z-ERC-LS-OZ-33	8AD	71,00 €	8AD0330012	Z-ERC-LS-ZM-33	8AD	106,00 €
8AD0340013	Z-ERC-LS-OZ-34	8ADL	61,00 €	8AD0340012	Z-ERC-LS-ZM-34	8AD	107,00 €
8AD0350013	Z-ERC-LS-OZ-35	8ADL	61,00 €	8AD0350012	Z-ERC-LS-ZM-35	8AD	107,00 €
8AD0360013	Z-ERC-LS-OZ-36	8ADL	62,00 €	8AD0360012	Z-ERC-LS-ZM-36	8AD	109,00 €
8AD0370013	Z-ERC-LS-OZ-37	8AD	74,00 €	8AD0370012	Z-ERC-LS-ZM-37	8AD	110,00 €
8AD0380013	Z-ERC-LS-OZ-38	8ADL	64,00 €	8AD0380012	Z-ERC-LS-ZM-38	8AD	112,00 €
8AD0390013	Z-ERC-LS-OZ-39	8AD	76,00 €	8AD0390012	Z-ERC-LS-ZM-39	8AD	118,00 €
8AD0400013	Z-ERC-LS-OZ-40	8ADL	65,00 €	8AD0400012	Z-ERC-LS-ZM-40	8AD	118,00 €
8AD0410013	Z-ERC-LS-OZ-41	8AD	80,00 €	8AD0410012	Z-ERC-LS-ZM-41	8AD	125,00 €
8AD0420013	Z-ERC-LS-OZ-42	8ADL	69,00 €	8AD0420012	Z-ERC-LS-ZM-42	8AD	125,00 €
8AD0430013	Z-ERC-LS-OZ-43	8AD	85,00 €	8AD0430012	Z-ERC-LS-ZM-43	8AD	125,00 €
8AD0440013	Z-ERC-LS-OZ-44	8ADL	72,00 €	8AD0440012	Z-ERC-LS-ZM-44	8AD	128,00 €
8AD0450013	Z-ERC-LS-OZ-45	8ADL	74,00 €	8AD0450012	Z-ERC-LS-ZM-45	8AD	131,00 €
8AD0460013	Z-ERC-LS-OZ-46	8ADL	76,00 €	8AD0460012	Z-ERC-LS-ZM-46	8AD	135,00 €
8AD0470013	Z-ERC-LS-OZ-47	8AD	91,00 €	8AD0470012	Z-ERC-LS-ZM-47	8AD	138,00 €
8AD0480013	Z-ERC-LS-OZ-48	8AD	93,00 €	8AD0480012	Z-ERC-LS-ZM-48	8AD	144,00 €
8AD0490013	Z-ERC-LS-OZ-49	8AD	98,00 €	8AD0490012	Z-ERC-LS-ZM-49	8AD	149,00 €
8AD0500013	Z-ERC-LS-OZ-50	8ADL	84,00 €	8AD0500012	Z-ERC-LS-ZM-50	8AD	149,00 €
8AD0520013	Z-ERC-LS-OZ-52	8AD	101,00 €	8AD0520012	Z-ERC-LS-ZM-52	8AD	159,00 €
8AD0540013	Z-ERC-LS-OZ-54	8AD	108,00 €	8AD0540012	Z-ERC-LS-ZM-54	8AD	168,00 €
8AD0550013	Z-ERC-LS-OZ-55	8ADL	92,00 €	8AD0550012	Z-ERC-LS-ZM-55	8AD	168,00 €
8AD0560013	Z-ERC-LS-OZ-56	8AD	114,00 €	8AD0560012	Z-ERC-LS-ZM-56	8AD	175,00 €
8AD0580013	Z-ERC-LS-OZ-58	8AD	114,00 €	8AD0580012	Z-ERC-LS-ZM-58	8AD	175,00 €
8AD0600013	Z-ERC-LS-OZ-60	8ADL	101,00 €	8AD0600012	Z-ERC-LS-ZM-60	8AD	181,00 €
8AD0620013	Z-ERC-LS-OZ-62	8AD	123,00 €	8AD0620012	Z-ERC-LS-ZM-62	8AD	193,00 €
8AD0640013	Z-ERC-LS-OZ-64	8AD	131,00 €	8AD0640012	Z-ERC-LS-ZM-64	8AD	204,00 €
8AD0650013	Z-ERC-LS-OZ-65	8ADL	112,00 €	8AD0650012	Z-ERC-LS-ZM-65	8AD	204,00 €
8AD0660013	Z-ERC-LS-OZ-66	8AD	138,00 €	8AD0660012	Z-ERC-LS-ZM-66	8AD	212,00 €
8AD0680013	Z-ERC-LS-OZ-68	8AD	138,00 €	8AD0680012	Z-ERC-LS-ZM-68	8AD	212,00 €
8AD0700013	Z-ERC-LS-OZ-70	8ADL	123,00 €	8AD0700012	Z-ERC-LS-ZM-70	8AD	220,00 €
8AD0720013	Z-ERC-LS-OZ-72	8AD	149,00 €	8AD0720012	Z-ERC-LS-ZM-72	8AD	230,00 €
8AD0740013	Z-ERC-LS-OZ-74	8AD	156,00 €	8AD0740012	Z-ERC-LS-ZM-74	8AD	241,00 €
8AD0750013	Z-ERC-LS-OZ-75	8ADL	133,00 €	8AD0750012	Z-ERC-LS-ZM-75	8AD	241,00 €
8AD0760013	Z-ERC-LS-OZ-76	8AD	163,00 €	8AD0760012	Z-ERC-LS-ZM-76	8AD	249,00 €

ANr.	Beschreibung	AGr.	Einzelpreis	ANr.	Beschreibung	AGr.	Einzelpreis
<b>Einstellringe DIN 2250, Form C, ohne ZM</b>				<b>Einstellringe DIN 2250, Form C, mit ZM</b>			
8AD0780013	Z-ERC-LS-OZ-78	8AD	163,00 €	8AD0780012	Z-ERC-LS-ZM-78	8AD	249,00 €
8AD0800013	Z-ERC-LS-OZ-80	8ADL	145,00 €	8AD0800012	Z-ERC-LS-ZM-80	8AD	262,00 €
8AD0820013	Z-ERC-LS-OZ-82	8AD	178,00 €	8AD0820012	Z-ERC-LS-ZM-82	8AD	280,00 €
8AD0840013	Z-ERC-LS-OZ-84	8AD	190,00 €	8AD0840012	Z-ERC-LS-ZM-84	8AD	299,00 €
8AD0850013	Z-ERC-LS-OZ-85	8ADL	163,00 €	8AD0850012	Z-ERC-LS-ZM-85	8AD	299,00 €
8AD0860013	Z-ERC-LS-OZ-86	8AD	203,00 €	8AD0860012	Z-ERC-LS-ZM-86	8AD	312,00 €
8AD0880013	Z-ERC-LS-OZ-88	8AD	203,00 €	8AD0880012	Z-ERC-LS-ZM-88	8AD	312,00 €
8AD0900013	Z-ERC-LS-OZ-90	8ADL	181,00 €	8AD0900012	Z-ERC-LS-ZM-90	8AD	323,00 €
8AD0920013	Z-ERC-LS-OZ-92	8AD	219,00 €	8AD0920012	Z-ERC-LS-ZM-92	8AD	342,00 €
8AD0940013	Z-ERC-LS-OZ-94	8AD	232,00 €	8AD0940012	Z-ERC-LS-ZM-94	8AD	360,00 €
8AD0950013	Z-ERC-LS-OZ-95	8ADL	199,00 €	8AD0950012	Z-ERC-LS-ZM-95	8AD	360,00 €
8AD0960013	Z-ERC-LS-OZ-96	8AD	244,00 €	8AD0960012	Z-ERC-LS-ZM-96	8AD	373,00 €
8AD0980013	Z-ERC-LS-OZ-98	8AD	244,00 €	8AD0980012	Z-ERC-LS-ZM-98	8AD	373,00 €
8AD1000013	Z-ERC-LS-OZ-100	8ADL	217,00 €	8AD1000012	Z-ERC-LS-ZM-100	8AD	393,00 €
8AD1050013	Z-ERC-LS-OZ-105	8AD	266,00 €	8AD1050012	Z-ERC-LS-ZM-105	8AD	410,00 €
8AD1100013	Z-ERC-LS-OZ-110	8AD	278,00 €	8AD1100012	Z-ERC-LS-ZM-110	8AD	430,00 €
8AD1150013	Z-ERC-LS-OZ-115	8AD	291,00 €	8AD1150012	Z-ERC-LS-ZM-115	8AD	447,00 €
8AD1200013	Z-ERC-LS-OZ-120	8AD	303,00 €	8AD1200012	Z-ERC-LS-ZM-120	8AD	467,00 €
8AD1250013	Z-ERC-LS-OZ-125	8AD	316,00 €	8AD1250012	Z-ERC-LS-ZM-125	8AD	484,00 €
8AD1300013	Z-ERC-LS-OZ-130	8AD	328,00 €	8AD1300012	Z-ERC-LS-ZM-130	8AD	504,00 €
8AD1350013	Z-ERC-LS-OZ-135	8AD	341,00 €	8AD1350012	Z-ERC-LS-ZM-135	8AD	522,00 €
8AD1400013	Z-ERC-LS-OZ-140	8AD	353,00 €	8AD1400012	Z-ERC-LS-ZM-140	8AD	541,00 €
8AD1450013	Z-ERC-LS-OZ-145	8AD	366,00 €	8AD1450012	Z-ERC-LS-ZM-145	8AD	560,00 €
8AD1500013	Z-ERC-LS-OZ-150	8AD	380,00 €	8AD1500012	Z-ERC-LS-ZM-150	8AD	610,00 €
8AD1550013	Z-ERC-LS-OZ-155	8AD	413,00 €	8AD1550012	Z-ERC-LS-ZM-155	8AD	662,00 €
8AD1600013	Z-ERC-LS-OZ-160	8AD	448,00 €	8AD1600012	Z-ERC-LS-ZM-160	8AD	579,00 €
8AD1650013	Z-ERC-LS-OZ-165	8AD	482,00 €	8AD1650012	Z-ERC-LS-ZM-165	8AD	764,00 €
8AD1700013	Z-ERC-LS-OZ-170	8AD	517,00 €	8AD1700012	Z-ERC-LS-ZM-170	8AD	813,00 €
8AD1750013	Z-ERC-LS-OZ-175	8AD	551,00 €	8AD1750012	Z-ERC-LS-ZM-175	8AD	865,00 €
8AD1800013	Z-ERC-LS-OZ-180	8AD	586,00 €	8AD1800012	Z-ERC-LS-ZM-180	8AD	917,00 €
8AD1850013	Z-ERC-LS-OZ-185	8AD	621,00 €	8AD1850012	Z-ERC-LS-ZM-185	8AD	967,00 €
8AD1900013	Z-ERC-LS-OZ-190	8AD	655,00 €	8AD1900012	Z-ERC-LS-ZM-190	8AD	1.018,00 €
8AD1950013	Z-ERC-LS-OZ-195	8AD	690,00 €	8AD1950012	Z-ERC-LS-ZM-195	8AD	1.068,00 €
8AD2000013	Z-ERC-LS-OZ-200	8AD	723,00 €	8AD2000012	Z-ERC-LS-ZM-200	8AD	1.123,00 €
8AD2050013	Z-ERC-LS-OZ-205	8AD	761,00 €	8AD2050012	Z-ERC-LS-ZM-205	8AD	1.178,00 €
8AD2100013	Z-ERC-LS-OZ-210	8AD	761,00 €	8AD2100012	Z-ERC-LS-ZM-210	8AD	1.178,00 €
8AD2150013	Z-ERC-LS-OZ-215	8AD	798,00 €	8AD2150012	Z-ERC-LS-ZM-215	8AD	1.233,00 €
8AD2200013	Z-ERC-LS-OZ-220	8AD	798,00 €	8AD2200012	Z-ERC-LS-ZM-220	8AD	1.233,00 €
8AD2250013	Z-ERC-LS-OZ-225	8AD	835,00 €	8AD2250012	Z-ERC-LS-ZM-225	8AD	1.288,00 €
8AD2300013	Z-ERC-LS-OZ-230	8AD	835,00 €	8AD2300012	Z-ERC-LS-ZM-230	8AD	1.288,00 €
8AD2400013	Z-ERC-LS-OZ-240	8AD	872,00 €	8AD2400012	Z-ERC-LS-ZM-240	8AD	1.342,00 €
8AD2500013	Z-ERC-LS-OZ-250	8AD	909,00 €	8AD2500012	Z-ERC-LS-ZM-250	8AD	1.396,00 €
8AD2600013	Z-ERC-LS-OZ-260	8AD	945,00 €	8AD2600012	Z-ERC-LS-ZM-260	8AD	1.451,00 €
8AD2700013	Z-ERC-LS-OZ-270	8AD	982,00 €	8AD2700012	Z-ERC-LS-ZM-270	8AD	1.505,00 €

ANr.	Beschreibung	AGr.	Einzelpreis	ANr.	Beschreibung	AGr.	Einzelpreis
<b>Einstellringe DIN 2250, Form C, ohne ZM</b>				<b>Einstellringe DIN 2250, Form C, mit ZM</b>			
8AD2750013	<b>Z-ERC-LS-OZ-275</b>	8AD	<b>1.019,00 €</b>	8AD2750012	<b>Z-ERC-LS-ZM-275</b>	8AD	<b>1.560,00 €</b>
8AD2800013	<b>Z-ERC-LS-OZ-280</b>	8AD	<b>1.019,00 €</b>	8AD2800012	<b>Z-ERC-LS-ZM-280</b>	8AD	<b>1.560,00 €</b>
8AD2900013	<b>Z-ERC-LS-OZ-290</b>	8AD	<b>1.057,00 €</b>	8AD2900012	<b>Z-ERC-LS-ZM-290</b>	8AD	<b>1.615,00 €</b>
8AD3000013	<b>Z-ERC-LS-OZ-300</b>	8AD	<b>1.094,00 €</b>	8AD3000012	<b>Z-ERC-LS-ZM-300</b>	8AD	<b>1.678,00 €</b>
8AD3100013	<b>Z-ERC-LS-OZ-310</b>	8AD	<b>1.136,00 €</b>	8AD3100012	<b>Z-ERC-LS-ZM-310</b>	8AD	<b>1.702,00 €</b>
8AD3150013	<b>Z-ERC-LS-OZ-315</b>	8AD	<b>1.153,00 €</b>	8AD3150012	<b>Z-ERC-LS-ZM-315</b>	8AD	<b>1.702,00 €</b>



ANr.	Beschreibung	AGr.	Einzelpreis	ANr.	Beschreibung	AGr.	Einzelpreis
------	--------------	------	-------------	------	--------------	------	-------------

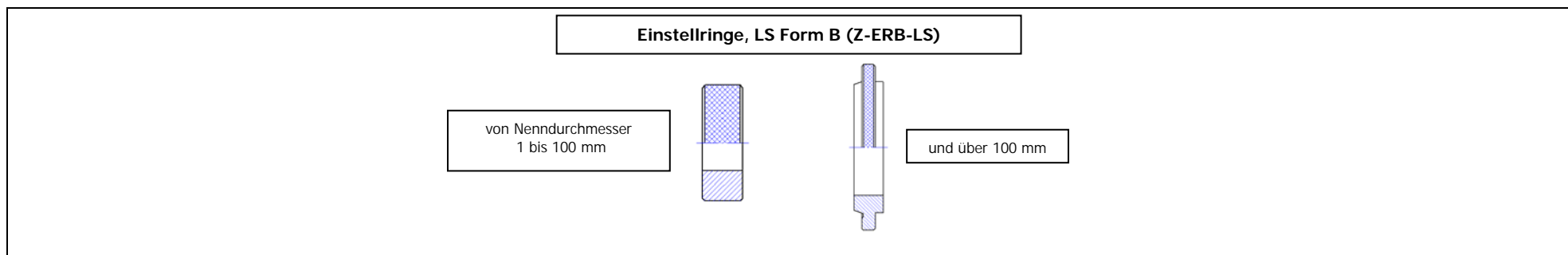

Einstellringe DIN 2250, Form B, ohne ZM				Einstellringe DIN 2250, Form B, mit ZM			
8AE0010013	Z-ERB-LS-OZ-1	8AE	260,00 €	8AE0010012	Z-ERB-LS-ZM-1	8AE	312,00 €
8AE0012013	Z-ERB-LS-OZ-1,2	8AE	270,00 €	8AE0012012	Z-ERB-LS-ZM-1,2	8AE	324,00 €
8AE0015013	Z-ERB-LS-OZ-1,5	8AE	270,00 €	8AE0015012	Z-ERB-LS-ZM-1,5	8AE	324,00 €
8AE0018013	Z-ERB-LS-OZ-1,8	8AE	270,00 €	8AE0018012	Z-ERB-LS-ZM-1,8	8AE	324,00 €
8AE0020013	Z-ERB-LS-OZ-2	8AE	220,00 €	8AE0020012	Z-ERB-LS-ZM-2	8AE	264,00 €
8AE0022013	Z-ERB-LS-OZ-2,2	8AE	230,00 €	8AE0022012	Z-ERB-LS-ZM-2,2	8AE	276,00 €
8AE0025013	Z-ERB-LS-OZ-2,5	8AE	240,00 €	8AE0025012	Z-ERB-LS-ZM-2,5	8AE	288,00 €
8AE0028013	Z-ERB-LS-OZ-2,8	8AE	244,00 €	8AE0028012	Z-ERB-LS-ZM-2,8	8AE	293,00 €
8AE0030013	Z-ERB-LS-OZ-3	8AE	98,00 €	8AE0030012	Z-ERB-LS-ZM-3	8AE	120,00 €
8AE0035013	Z-ERB-LS-OZ-3,5	8AE	98,00 €	8AE0035012	Z-ERB-LS-ZM-3,5	8AE	118,00 €
8AE0040013	Z-ERB-LS-OZ-4	8AE	96,00 €	8AE0040012	Z-ERB-LS-ZM-4	8AE	118,00 €
8AE0045013	Z-ERB-LS-OZ-4,5	8AE	96,00 €	8AE0045012	Z-ERB-LS-ZM-4,5	8AE	118,00 €
8AE0050013	Z-ERB-LS-OZ-5	8AE	95,00 €	8AE0050012	Z-ERB-LS-ZM-5	8AE	116,00 €
8AE0060013	Z-ERB-LS-OZ-6	8AE	93,00 €	8AE0060012	Z-ERB-LS-ZM-6	8AE	113,00 €
8AE0070013	Z-ERB-LS-OZ-7	8AE	93,00 €	8AE0070012	Z-ERB-LS-ZM-7	8AE	113,00 €
8AE0080013	Z-ERB-LS-OZ-8	8AE	93,00 €	8AE0080012	Z-ERB-LS-ZM-8	8AE	113,00 €
8AE0090013	Z-ERB-LS-OZ-9	8AE	93,00 €	8AE0090012	Z-ERB-LS-ZM-9	8AE	113,00 €
8AE0100013	Z-ERB-LS-OZ-10	8AE	93,00 €	8AE0100012	Z-ERB-LS-ZM-10	8AE	113,00 €
8AE0110013	Z-ERB-LS-OZ-11	8AE	95,00 €	8AE0110012	Z-ERB-LS-ZM-11	8AE	116,00 €
8AE0120013	Z-ERB-LS-OZ-12	8AE	96,00 €	8AE0120012	Z-ERB-LS-ZM-12	8AE	118,00 €
8AE0130013	Z-ERB-LS-OZ-13	8AE	98,00 €	8AE0130012	Z-ERB-LS-ZM-13	8AE	120,00 €
8AE0140013	Z-ERB-LS-OZ-14	8AE	98,00 €	8AE0140012	Z-ERB-LS-ZM-14	8AE	120,00 €
8AE0150013	Z-ERB-LS-OZ-15	8AE	100,00 €	8AE0150012	Z-ERB-LS-ZM-15	8AE	123,00 €
8AE0160013	Z-ERB-LS-OZ-16	8AE	102,00 €	8AE0160012	Z-ERB-LS-ZM-16	8AE	125,00 €
8AE0170013	Z-ERB-LS-OZ-17	8AE	104,00 €	8AE0170012	Z-ERB-LS-ZM-17	8AE	127,00 €
8AE0180013	Z-ERB-LS-OZ-18	8AE	104,00 €	8AE0180012	Z-ERB-LS-ZM-18	8AE	127,00 €
8AE0190013	Z-ERB-LS-OZ-19	8AE	106,00 €	8AE0190012	Z-ERB-LS-ZM-19	8AE	130,00 €
8AE0200013	Z-ERB-LS-OZ-20	8AE	109,00 €	8AE0200012	Z-ERB-LS-ZM-20	8AE	133,00 €
8AE0210013	Z-ERB-LS-OZ-21	8AE	111,00 €	8AE0210012	Z-ERB-LS-ZM-21	8AE	135,00 €
8AE0220013	Z-ERB-LS-OZ-22	8AE	111,00 €	8AE0220012	Z-ERB-LS-ZM-22	8AE	135,00 €

ANr.	Beschreibung	AGr.	Einzelpreis	ANr.	Beschreibung	AGr.	Einzelpreis
<b>Einstellringe DIN 2250, Form B, ohne ZM</b>				<b>Einstellringe DIN 2250, Form B, mit ZM</b>			
8AE0230013	Z-ERB-LS-OZ-23	8AE	112,00 €	8AE0230012	Z-ERB-LS-ZM-23	8AE	137,00 €
8AE0240013	Z-ERB-LS-OZ-24	8AE	114,00 €	8AE0240012	Z-ERB-LS-ZM-24	8AE	140,00 €
8AE0250013	Z-ERB-LS-OZ-25	8AE	116,00 €	8AE0250012	Z-ERB-LS-ZM-25	8AE	142,00 €
8AE0260013	Z-ERB-LS-OZ-26	8AE	118,00 €	8AE0260012	Z-ERB-LS-ZM-26	8AE	144,00 €
8AE0270013	Z-ERB-LS-OZ-27	8AE	118,00 €	8AE0270012	Z-ERB-LS-ZM-27	8AE	144,00 €
8AE0280013	Z-ERB-LS-OZ-28	8AE	120,00 €	8AE0280012	Z-ERB-LS-ZM-28	8AE	149,00 €
8AE0290013	Z-ERB-LS-OZ-29	8AE	125,00 €	8AE0290012	Z-ERB-LS-ZM-29	8AE	152,00 €
8AE0300013	Z-ERB-LS-OZ-30	8AE	125,00 €	8AE0300012	Z-ERB-LS-ZM-30	8AE	152,00 €
8AE0310013	Z-ERB-LS-OZ-31	8AE	127,00 €	8AE0310012	Z-ERB-LS-ZM-31	8AE	154,00 €
8AE0320013	Z-ERB-LS-OZ-32	8AE	127,00 €	8AE0320012	Z-ERB-LS-ZM-32	8AE	154,00 €
8AE0330013	Z-ERB-LS-OZ-33	8AE	128,00 €	8AE0330012	Z-ERB-LS-ZM-33	8AE	156,00 €
8AE0340013	Z-ERB-LS-OZ-34	8AE	130,00 €	8AE0340012	Z-ERB-LS-ZM-34	8AE	156,00 €
8AE0350013	Z-ERB-LS-OZ-35	8AE	130,00 €	8AE0350012	Z-ERB-LS-ZM-35	8AE	159,00 €
8AE0360013	Z-ERB-LS-OZ-36	8AE	132,00 €	8AE0360012	Z-ERB-LS-ZM-36	8AE	161,00 €
8AE0370013	Z-ERB-LS-OZ-37	8AE	134,00 €	8AE0370012	Z-ERB-LS-ZM-37	8AE	163,00 €
8AE0380013	Z-ERB-LS-OZ-38	8AE	136,00 €	8AE0380012	Z-ERB-LS-ZM-38	8AE	166,00 €
8AE0390013	Z-ERB-LS-OZ-39	8AE	138,00 €	8AE0390012	Z-ERB-LS-ZM-39	8AE	176,00 €
8AE0400013	Z-ERB-LS-OZ-40	8AE	138,00 €	8AE0400012	Z-ERB-LS-ZM-40	8AE	176,00 €
8AE0410013	Z-ERB-LS-OZ-41	8AE	146,00 €	8AE0410012	Z-ERB-LS-ZM-41	8AE	185,00 €
8AE0420013	Z-ERB-LS-OZ-42	8AE	146,00 €	8AE0420012	Z-ERB-LS-ZM-42	8AE	185,00 €
8AE0430013	Z-ERB-LS-OZ-43	8AE	154,00 €	8AE0430012	Z-ERB-LS-ZM-43	8AE	190,00 €
8AE0440013	Z-ERB-LS-OZ-44	8AE	154,00 €	8AE0440012	Z-ERB-LS-ZM-44	8AE	190,00 €
8AE0450013	Z-ERB-LS-OZ-45	8AE	158,00 €	8AE0450012	Z-ERB-LS-ZM-45	8AE	195,00 €
8AE0460013	Z-ERB-LS-OZ-46	8AE	162,00 €	8AE0460012	Z-ERB-LS-ZM-46	8AE	199,00 €
8AE0470013	Z-ERB-LS-OZ-47	8AE	166,00 €	8AE0470012	Z-ERB-LS-ZM-47	8AE	204,00 €
8AE0480013	Z-ERB-LS-OZ-48	8AE	170,00 €	8AE0480012	Z-ERB-LS-ZM-48	8AE	214,00 €
8AE0490013	Z-ERB-LS-OZ-49	8AE	178,00 €	8AE0490012	Z-ERB-LS-ZM-49	8AE	221,00 €
8AE0500013	Z-ERB-LS-OZ-50	8AE	178,00 €	8AE0500012	Z-ERB-LS-ZM-50	8AE	236,00 €
8AE0520013	Z-ERB-LS-OZ-52	8AE	184,00 €	8AE0520012	Z-ERB-LS-ZM-52	8AE	236,00 €
8AE0540013	Z-ERB-LS-OZ-54	8AE	196,00 €	8AE0540012	Z-ERB-LS-ZM-54	8AE	250,00 €
8AE0550013	Z-ERB-LS-OZ-55	8AE	196,00 €	8AE0550012	Z-ERB-LS-ZM-55	8AE	250,00 €
8AE0560013	Z-ERB-LS-OZ-56	8AE	208,00 €	8AE0560012	Z-ERB-LS-ZM-56	8AE	259,00 €
8AE0580013	Z-ERB-LS-OZ-58	8AE	208,00 €	8AE0580012	Z-ERB-LS-ZM-58	8AE	259,00 €
8AE0600013	Z-ERB-LS-OZ-60	8AE	216,00 €	8AE0600012	Z-ERB-LS-ZM-60	8AE	269,00 €
8AE0620013	Z-ERB-LS-OZ-62	8AE	224,00 €	8AE0620012	Z-ERB-LS-ZM-62	8AE	286,00 €
8AE0640013	Z-ERB-LS-OZ-64	8AE	238,00 €	8AE0640012	Z-ERB-LS-ZM-64	8AE	302,00 €
8AE0650013	Z-ERB-LS-OZ-65	8AE	238,00 €	8AE0650012	Z-ERB-LS-ZM-65	8AE	302,00 €
8AE0660013	Z-ERB-LS-OZ-66	8AE	252,00 €	8AE0660012	Z-ERB-LS-ZM-66	8AE	314,00 €
8AE0680013	Z-ERB-LS-OZ-68	8AE	252,00 €	8AE0680012	Z-ERB-LS-ZM-68	8AE	314,00 €
8AE0700013	Z-ERB-LS-OZ-70	8AE	262,00 €	8AE0700012	Z-ERB-LS-ZM-70	8AE	326,00 €
8AE0720013	Z-ERB-LS-OZ-72	8AE	272,00 €	8AE0720012	Z-ERB-LS-ZM-72	8AE	341,00 €
8AE0740013	Z-ERB-LS-OZ-74	8AE	284,00 €	8AE0740012	Z-ERB-LS-ZM-74	8AE	357,00 €
8AE0750013	Z-ERB-LS-OZ-75	8AE	284,00 €	8AE0750012	Z-ERB-LS-ZM-75	8AE	357,00 €
8AE0760013	Z-ERB-LS-OZ-76	8AE	298,00 €	8AE0760012	Z-ERB-LS-ZM-76	8AE	369,00 €

ANr.	Beschreibung	AGr.	Einzelpreis	ANr.	Beschreibung	AGr.	Einzelpreis
<b>Einstellringe DIN 2250, Form B, ohne ZM</b>				<b>Einstellringe DIN 2250, Form B, mit ZM</b>			
8AE0780013	<b>Z-ERB-LS-OZ-78</b>	8AE	<b>298,00 €</b>	8AE0780012	<b>Z-ERB-LS-ZM-78</b>	8AE	<b>369,00 €</b>
8AE0800013	<b>Z-ERB-LS-OZ-80</b>	8AE	<b>308,00 €</b>	8AE0800012	<b>Z-ERB-LS-ZM-80</b>	8AE	<b>389,00 €</b>
8AE0820013	<b>Z-ERB-LS-OZ-82</b>	8AE	<b>324,00 €</b>	8AE0820012	<b>Z-ERB-LS-ZM-82</b>	8AE	<b>415,00 €</b>
8AE0840013	<b>Z-ERB-LS-OZ-84</b>	8AE	<b>346,00 €</b>	8AE0840012	<b>Z-ERB-LS-ZM-84</b>	8AE	<b>443,00 €</b>
8AE0850013	<b>Z-ERB-LS-OZ-85</b>	8AE	<b>346,00 €</b>	8AE0850012	<b>Z-ERB-LS-ZM-85</b>	8AE	<b>443,00 €</b>
8AE0860013	<b>Z-ERB-LS-OZ-86</b>	8AE	<b>370,00 €</b>	8AE0860012	<b>Z-ERB-LS-ZM-86</b>	8AE	<b>463,00 €</b>
8AE0880013	<b>Z-ERB-LS-OZ-88</b>	8AE	<b>370,00 €</b>	8AE0880012	<b>Z-ERB-LS-ZM-88</b>	8AE	<b>463,00 €</b>
8AE0900013	<b>Z-ERB-LS-OZ-90</b>	8AE	<b>386,00 €</b>	8AE0900012	<b>Z-ERB-LS-ZM-90</b>	8AE	<b>479,00 €</b>
8AE0920013	<b>Z-ERB-LS-OZ-92</b>	8AE	<b>400,00 €</b>	8AE0920012	<b>Z-ERB-LS-ZM-92</b>	8AE	<b>508,00 €</b>
8AE0940013	<b>Z-ERB-LS-OZ-94</b>	8AE	<b>423,00 €</b>	8AE0940012	<b>Z-ERB-LS-ZM-94</b>	8AE	<b>535,00 €</b>
8AE0950013	<b>Z-ERB-LS-OZ-95</b>	8AE	<b>423,00 €</b>	8AE0950012	<b>Z-ERB-LS-ZM-95</b>	8AE	<b>535,00 €</b>
8AE0960013	<b>Z-ERB-LS-OZ-96</b>	8AE	<b>446,00 €</b>	8AE0960012	<b>Z-ERB-LS-ZM-96</b>	8AE	<b>507,00 €</b>
8AE0980013	<b>Z-ERB-LS-OZ-98</b>	8AE	<b>446,00 €</b>	8AE0980012	<b>Z-ERB-LS-ZM-98</b>	8AE	<b>554,00 €</b>
8AE1000013	<b>Z-ERB-LS-OZ-100</b>	8AE	<b>462,00 €</b>	8AE1000012	<b>Z-ERB-LS-ZM-100</b>	8AE	<b>572,00 €</b>

ANr.	Beschreibung	AGr.	Einzelpreis	ANr.	Beschreibung	AGr.	Einzelpreis
------	--------------	------	-------------	------	--------------	------	-------------

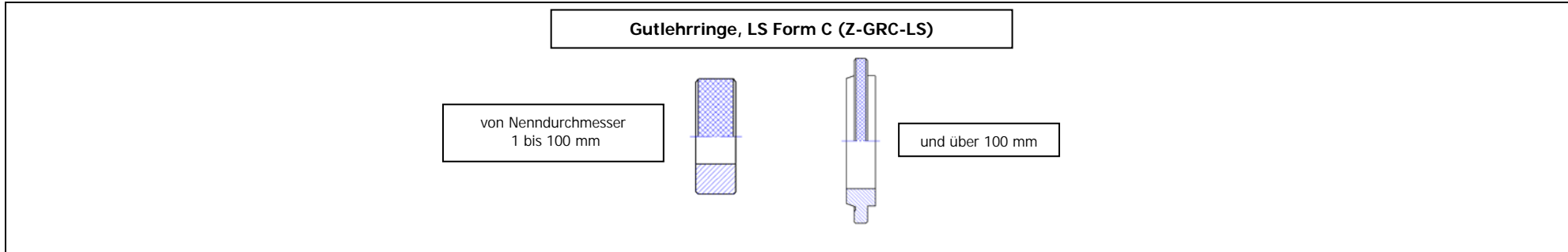

Gutlehringe DIN 2250, Form C, ohne ZM				Gutlehringe DIN 2250, Form C, mit ZM			
8AF0010014	Z-GRC-LS-And-1	8AF	218,00 €	8AF0010012	Z-GRC-LS-ZM-1	8AF	218,00 €
8AF0012014	Z-GRC-LS-And-1,2	8AF	218,00 €	8AF0012012	Z-GRC-LS-ZM-1,2	8AF	218,00 €
8AF0015014	Z-GRC-LS-And-1,5	8AF	218,00 €	8AF0015012	Z-GRC-LS-ZM-1,5	8AF	218,00 €
8AF0018014	Z-GRC-LS-And-1,8	8AF	218,00 €	8AF0018012	Z-GRC-LS-ZM-1,8	8AF	218,00 €
8AF0020014	Z-GRC-LS-And-2	8AF	186,00 €	8AF0020012	Z-GRC-LS-ZM-2	8AF	186,00 €
8AF0022014	Z-GRC-LS-And-2,2	8AF	194,00 €	8AF0022012	Z-GRC-LS-ZM-2,2	8AF	194,00 €
8AF0025014	Z-GRC-LS-And-2,5	8AF	197,00 €	8AF0025012	Z-GRC-LS-ZM-2,5	8AF	197,00 €
8AF0028014	Z-GRC-LS-And-2,8	8AF	197,00 €	8AF0028012	Z-GRC-LS-ZM-2,8	8AF	197,00 €
8AF0030014	Z-GRC-LS-And-3	8AF	81,00 €	8AF0030012	Z-GRC-LS-ZM-3	8AF	81,00 €
8AF0035014	Z-GRC-LS-And-3,5	8AF	81,00 €	8AF0035012	Z-GRC-LS-ZM-3,5	8AF	81,00 €
8AF0040014	Z-GRC-LS-And-4	8AF	80,00 €	8AF0040012	Z-GRC-LS-ZM-4	8AF	80,00 €
8AF0045014	Z-GRC-LS-And-4,5	8AF	80,00 €	8AF0045012	Z-GRC-LS-ZM-4,5	8AF	80,00 €
8AF0050014	Z-GRC-LS-And-5	8AF	78,00 €	8AF0050012	Z-GRC-LS-ZM-5	8AF	78,00 €
8AF0060014	Z-GRC-LS-And-6	8AF	77,00 €	8AF0060012	Z-GRC-LS-ZM-6	8AF	77,00 €
8AF0070014	Z-GRC-LS-And-7	8AF	77,00 €	8AF0070012	Z-GRC-LS-ZM-7	8AF	77,00 €
8AF0080014	Z-GRC-LS-And-8	8AF	77,00 €	8AF0080012	Z-GRC-LS-ZM-8	8AF	77,00 €
8AF0090014	Z-GRC-LS-And-9	8AF	77,00 €	8AF0090012	Z-GRC-LS-ZM-9	8AF	77,00 €
8AF0100014	Z-GRC-LS-And-10	8AF	77,00 €	8AF0100012	Z-GRC-LS-ZM-10	8AF	77,00 €
8AF0110014	Z-GRC-LS-And-11	8AF	78,00 €	8AF0110012	Z-GRC-LS-ZM-11	8AF	78,00 €
8AF0120014	Z-GRC-LS-And-12	8AF	81,00 €	8AF0120012	Z-GRC-LS-ZM-12	8AF	81,00 €
8AF0130014	Z-GRC-LS-And-13	8AF	81,00 €	8AF0130012	Z-GRC-LS-ZM-13	8AF	81,00 €
8AF0140014	Z-GRC-LS-And-14	8AF	81,00 €	8AF0140012	Z-GRC-LS-ZM-14	8AF	81,00 €
8AF0150014	Z-GRC-LS-And-15	8AF	83,00 €	8AF0150012	Z-GRC-LS-ZM-15	8AF	83,00 €
8AF0160014	Z-GRC-LS-And-16	8AF	84,00 €	8AF0160012	Z-GRC-LS-ZM-16	8AF	84,00 €
8AF0170014	Z-GRC-LS-And-17	8AF	86,00 €	8AF0170012	Z-GRC-LS-ZM-17	8AF	86,00 €
8AF0180014	Z-GRC-LS-And-18	8AF	86,00 €	8AF0180012	Z-GRC-LS-ZM-18	8AF	86,00 €
8AF0190014	Z-GRC-LS-And-19	8AF	88,00 €	8AF0190012	Z-GRC-LS-ZM-19	8AF	88,00 €
8AF0200014	Z-GRC-LS-And-20	8AF	89,00 €	8AF0200012	Z-GRC-LS-ZM-20	8AF	89,00 €
8AF0210014	Z-GRC-LS-And-21	8AF	89,00 €	8AF0210012	Z-GRC-LS-ZM-21	8AF	89,00 €

ANr.	Beschreibung	AGr.	Einzelpreis	ANr.	Beschreibung	AGr.	Einzelpreis
<b>Gutlehrringe DIN 2250, Form C, ohne ZM</b>				<b>Gutlehrringe DIN 2250, Form C, mit ZM</b>			
8AF0220014	Z-GRC-LS-And-22	8AF	91,00 €	8AF0220012	Z-GRC-LS-ZM-22	8AF	91,00 €
8AF0230014	Z-GRC-LS-And-23	8AF	93,00 €	8AF0230012	Z-GRC-LS-ZM-23	8AF	93,00 €
8AF0240014	Z-GRC-LS-And-24	8AF	94,00 €	8AF0240012	Z-GRC-LS-ZM-24	8AF	94,00 €
8AF0250014	Z-GRC-LS-And-25	8AF	96,00 €	8AF0250012	Z-GRC-LS-ZM-25	8AF	96,00 €
8AF0260014	Z-GRC-LS-And-26	8AF	97,00 €	8AF0260012	Z-GRC-LS-ZM-26	8AF	97,00 €
8AF0270014	Z-GRC-LS-And-27	8AF	97,00 €	8AF0270012	Z-GRC-LS-ZM-27	8AF	97,00 €
8AF0280014	Z-GRC-LS-And-28	8AF	97,00 €	8AF0280012	Z-GRC-LS-ZM-28	8AF	97,00 €
8AF0290014	Z-GRC-LS-And-29	8AF	102,00 €	8AF0290012	Z-GRC-LS-ZM-29	8AF	102,00 €
8AF0300014	Z-GRC-LS-And-30	8AF	102,00 €	8AF0300012	Z-GRC-LS-ZM-30	8AF	102,00 €
8AF0310014	Z-GRC-LS-And-31	8AF	104,00 €	8AF0310012	Z-GRC-LS-ZM-31	8AF	104,00 €
8AF0320014	Z-GRC-LS-And-32	8AF	104,00 €	8AF0320012	Z-GRC-LS-ZM-32	8AF	104,00 €
8AF0330014	Z-GRC-LS-And-33	8AF	106,00 €	8AF0330012	Z-GRC-LS-ZM-33	8AF	106,00 €
8AF0340014	Z-GRC-LS-And-34	8AF	107,00 €	8AF0340012	Z-GRC-LS-ZM-34	8AF	107,00 €
8AF0350014	Z-GRC-LS-And-35	8AF	107,00 €	8AF0350012	Z-GRC-LS-ZM-35	8AF	107,00 €
8AF0360014	Z-GRC-LS-And-36	8AF	109,00 €	8AF0360012	Z-GRC-LS-ZM-36	8AF	109,00 €
8AF0370014	Z-GRC-LS-And-37	8AF	110,00 €	8AF0370012	Z-GRC-LS-ZM-37	8AF	110,00 €
8AF0380014	Z-GRC-LS-And-38	8AF	112,00 €	8AF0380012	Z-GRC-LS-ZM-38	8AF	112,00 €
8AF0390014	Z-GRC-LS-And-39	8AF	118,00 €	8AF0390012	Z-GRC-LS-ZM-39	8AF	118,00 €
8AF0400014	Z-GRC-LS-And-40	8AF	118,00 €	8AF0400012	Z-GRC-LS-ZM-40	8AF	118,00 €
8AF0410014	Z-GRC-LS-And-41	8AF	125,00 €	8AF0410012	Z-GRC-LS-ZM-41	8AF	125,00 €
8AF0420014	Z-GRC-LS-And-42	8AF	125,00 €	8AF0420012	Z-GRC-LS-ZM-42	8AF	125,00 €
8AF0430014	Z-GRC-LS-And-43	8AF	128,00 €	8AF0430012	Z-GRC-LS-ZM-43	8AF	128,00 €
8AF0440014	Z-GRC-LS-And-44	8AF	128,00 €	8AF0440012	Z-GRC-LS-ZM-44	8AF	128,00 €
8AF0450014	Z-GRC-LS-And-45	8AF	131,00 €	8AF0450012	Z-GRC-LS-ZM-45	8AF	131,00 €
8AF0460014	Z-GRC-LS-And-46	8AF	135,00 €	8AF0460012	Z-GRC-LS-ZM-46	8AF	135,00 €
8AF0470014	Z-GRC-LS-And-47	8AF	138,00 €	8AF0470012	Z-GRC-LS-ZM-47	8AF	138,00 €
8AF0480014	Z-GRC-LS-And-48	8AF	144,00 €	8AF0480012	Z-GRC-LS-ZM-48	8AF	144,00 €
8AF0490014	Z-GRC-LS-And-49	8AF	149,00 €	8AF0490012	Z-GRC-LS-ZM-49	8AF	149,00 €
8AF0500014	Z-GRC-LS-And-50	8AF	149,00 €	8AF0500012	Z-GRC-LS-ZM-50	8AF	149,00 €
8AF0520014	Z-GRC-LS-And-52	8AF	159,00 €	8AF0520012	Z-GRC-LS-ZM-52	8AF	159,00 €
8AF0540014	Z-GRC-LS-And-54	8AF	168,00 €	8AF0540012	Z-GRC-LS-ZM-54	8AF	168,00 €
8AF0550014	Z-GRC-LS-And-55	8AF	168,00 €	8AF0550012	Z-GRC-LS-ZM-55	8AF	168,00 €
8AF0560014	Z-GRC-LS-And-56	8AF	175,00 €	8AF0560012	Z-GRC-LS-ZM-56	8AF	175,00 €
8AF0580014	Z-GRC-LS-And-58	8AF	175,00 €	8AF0580012	Z-GRC-LS-ZM-58	8AF	175,00 €
8AF0600014	Z-GRC-LS-And-60	8AF	181,00 €	8AF0600012	Z-GRC-LS-ZM-60	8AF	181,00 €
8AF0620014	Z-GRC-LS-And-62	8AF	193,00 €	8AF0620012	Z-GRC-LS-ZM-62	8AF	193,00 €
8AF0640014	Z-GRC-LS-And-64	8AF	204,00 €	8AF0640012	Z-GRC-LS-ZM-64	8AF	204,00 €
8AF0650014	Z-GRC-LS-And-65	8AF	204,00 €	8AF0650012	Z-GRC-LS-ZM-65	8AF	204,00 €
8AF0660014	Z-GRC-LS-And-66	8AF	212,00 €	8AF0660012	Z-GRC-LS-ZM-66	8AF	212,00 €
8AF0680014	Z-GRC-LS-And-68	8AF	212,00 €	8AF0680012	Z-GRC-LS-ZM-68	8AF	212,00 €
8AF0700014	Z-GRC-LS-And-70	8AF	220,00 €	8AF0700012	Z-GRC-LS-ZM-70	8AF	220,00 €
8AF0720014	Z-GRC-LS-And-72	8AF	230,00 €	8AF0720012	Z-GRC-LS-ZM-72	8AF	230,00 €
8AF0740014	Z-GRC-LS-And-74	8AF	241,00 €	8AF0740012	Z-GRC-LS-ZM-74	8AF	241,00 €
8AF0750014	Z-GRC-LS-And-75	8AF	241,00 €	8AF0750012	Z-GRC-LS-ZM-75	8AF	241,00 €



ANr.	Beschreibung	AGr.	Einzelpreis	ANr.	Beschreibung	AGr.	Einzelpreis
<b>Gutlehrringe DIN 2250, Form C, ohne ZM</b>				<b>Gutlehrringe DIN 2250, Form C, mit ZM</b>			
8AF0760014	Z-GRC-LS-And-76	8AF	249,00 €	8AF0760012	Z-GRC-LS-ZM-76	8AF	249,00 €
8AF0780014	Z-GRC-LS-And-78	8AF	249,00 €	8AF0780012	Z-GRC-LS-ZM-78	8AF	249,00 €
8AF0800014	Z-GRC-LS-And-80	8AF	262,00 €	8AF0800012	Z-GRC-LS-ZM-80	8AF	262,00 €
8AF0820014	Z-GRC-LS-And-82	8AF	280,00 €	8AF0820012	Z-GRC-LS-ZM-82	8AF	280,00 €
8AF0840014	Z-GRC-LS-And-84	8AF	299,00 €	8AF0840012	Z-GRC-LS-ZM-84	8AF	299,00 €
8AF0850014	Z-GRC-LS-And-85	8AF	299,00 €	8AF0850012	Z-GRC-LS-ZM-85	8AF	299,00 €
8AF0860014	Z-GRC-LS-And-86	8AF	312,00 €	8AF0860012	Z-GRC-LS-ZM-86	8AF	312,00 €
8AF0880014	Z-GRC-LS-And-88	8AF	312,00 €	8AF0880012	Z-GRC-LS-ZM-88	8AF	312,00 €
8AF0900014	Z-GRC-LS-And-90	8AF	323,00 €	8AF0900012	Z-GRC-LS-ZM-90	8AF	323,00 €
8AF0920014	Z-GRC-LS-And-92	8AF	342,00 €	8AF0920012	Z-GRC-LS-ZM-92	8AF	342,00 €
8AF0940014	Z-GRC-LS-And-94	8AF	360,00 €	8AF0940012	Z-GRC-LS-ZM-94	8AF	360,00 €
8AF0950014	Z-GRC-LS-And-95	8AF	360,00 €	8AF0950012	Z-GRC-LS-ZM-95	8AF	360,00 €
8AF0960014	Z-GRC-LS-And-96	8AF	373,00 €	8AF0960012	Z-GRC-LS-ZM-96	8AF	373,00 €
8AF0980014	Z-GRC-LS-And-98	8AF	373,00 €	8AF0980012	Z-GRC-LS-ZM-98	8AF	373,00 €
8AF1000014	Z-GRC-LS-And-100	8AF	393,00 €	8AF1000012	Z-GRC-LS-ZM-100	8AF	393,00 €
8AF1050014	Z-GRC-LS-And-105	8AF	410,00 €	8AF1050012	Z-GRC-LS-ZM-105	8AF	410,00 €
8AF1100014	Z-GRC-LS-And-110	8AF	430,00 €	8AF1100012	Z-GRC-LS-ZM-110	8AF	430,00 €
8AF1150014	Z-GRC-LS-And-115	8AF	447,00 €	8AF1150012	Z-GRC-LS-ZM-115	8AF	447,00 €
8AF1200014	Z-GRC-LS-And-120	8AF	467,00 €	8AF1200012	Z-GRC-LS-ZM-120	8AF	467,00 €
8AF1250014	Z-GRC-LS-And-125	8AF	484,00 €	8AF1250012	Z-GRC-LS-ZM-125	8AF	484,00 €
8AF1300014	Z-GRC-LS-And-130	8AF	504,00 €	8AF1300012	Z-GRC-LS-ZM-130	8AF	504,00 €
8AF1350014	Z-GRC-LS-And-135	8AF	522,00 €	8AF1350012	Z-GRC-LS-ZM-135	8AF	522,00 €
8AF1400014	Z-GRC-LS-And-140	8AF	541,00 €	8AF1400012	Z-GRC-LS-ZM-140	8AF	541,00 €
8AF1450014	Z-GRC-LS-And-145	8AF	560,00 €	8AF1450012	Z-GRC-LS-ZM-145	8AF	560,00 €
8AF1500014	Z-GRC-LS-And-150	8AF	610,00 €	8AF1500012	Z-GRC-LS-ZM-150	8AF	610,00 €
8AF1550014	Z-GRC-LS-And-155	8AF	662,00 €	8AF1550012	Z-GRC-LS-ZM-155	8AF	662,00 €
8AF1600014	Z-GRC-LS-And-160	8AF	712,00 €	8AF1600012	Z-GRC-LS-ZM-160	8AF	712,00 €
8AF1650014	Z-GRC-LS-And-165	8AF	764,00 €	8AF1650012	Z-GRC-LS-ZM-165	8AF	764,00 €
8AF1700014	Z-GRC-LS-And-170	8AF	813,00 €	8AF1700012	Z-GRC-LS-ZM-170	8AF	813,00 €
8AF1750014	Z-GRC-LS-And-175	8AF	865,00 €	8AF1750012	Z-GRC-LS-ZM-175	8AF	865,00 €
8AF1800014	Z-GRC-LS-And-180	8AF	917,00 €	8AF1800012	Z-GRC-LS-ZM-180	8AF	917,00 €
8AF1850014	Z-GRC-LS-And-185	8AF	967,00 €	8AF1850012	Z-GRC-LS-ZM-185	8AF	967,00 €
8AF1900014	Z-GRC-LS-And-190	8AF	1.018,00 €	8AF1900012	Z-GRC-LS-ZM-190	8AF	1.018,00 €
8AF1950014	Z-GRC-LS-And-195	8AF	1.068,00 €	8AF1950012	Z-GRC-LS-ZM-195	8AF	1.068,00 €
8AF2000014	Z-GRC-LS-And-200	8AF	1.123,00 €	8AF2000012	Z-GRC-LS-ZM-200	8AF	1.123,00 €
8AF2050014	Z-GRC-LS-And-205	8AF	1.178,00 €	8AF2050012	Z-GRC-LS-ZM-205	8AF	1.178,00 €
8AF2100014	Z-GRC-LS-And-210	8AF	1.178,00 €	8AF2100012	Z-GRC-LS-ZM-210	8AF	1.178,00 €
8AF2150014	Z-GRC-LS-And-215	8AF	1.233,00 €	8AF2150012	Z-GRC-LS-ZM-215	8AF	1.233,00 €
8AF2200014	Z-GRC-LS-And-220	8AF	1.233,00 €	8AF2200012	Z-GRC-LS-ZM-220	8AF	1.233,00 €
8AF2250014	Z-GRC-LS-And-225	8AF	1.288,00 €	8AF2250012	Z-GRC-LS-ZM-225	8AF	1.288,00 €
8AF2300014	Z-GRC-LS-And-230	8AF	1.288,00 €	8AF2300012	Z-GRC-LS-ZM-230	8AF	1.288,00 €
8AF2400014	Z-GRC-LS-And-240	8AF	1.342,00 €	8AF2400012	Z-GRC-LS-ZM-240	8AF	1.342,00 €
8AF2500014	Z-GRC-LS-And-250	8AF	1.396,00 €	8AF2500012	Z-GRC-LS-ZM-250	8AF	1.396,00 €
8AF2600014	Z-GRC-LS-And-260	8AF	1.451,00 €	8AF2600012	Z-GRC-LS-ZM-260	8AF	1.451,00 €



ANr.	Beschreibung	AGr.	Einzelpreis	ANr.	Beschreibung	AGr.	Einzelpreis
<b>Gutlehringe DIN 2250, Form C, ohne ZM</b>				<b>Gutlehringe DIN 2250, Form C, mit ZM</b>			
8AF2700014	<b>Z-GRC-LS-And-270</b>	8AF	<b>1.505,00 €</b>	8AF2700012	<b>Z-GRC-LS-ZM-270</b>	8AF	<b>1.505,00 €</b>
8AF2750014	<b>Z-GRC-LS-And-275</b>	8AF	<b>1.560,00 €</b>	8AF2750012	<b>Z-GRC-LS-ZM-275</b>	8AF	<b>1.560,00 €</b>
8AF2800014	<b>Z-GRC-LS-And-280</b>	8AF	<b>1.560,00 €</b>	8AF2800012	<b>Z-GRC-LS-ZM-280</b>	8AF	<b>1.560,00 €</b>
8AF2900014	<b>Z-GRC-LS-And-290</b>	8AF	<b>1.615,00 €</b>	8AF2900012	<b>Z-GRC-LS-ZM-290</b>	8AF	<b>1.615,00 €</b>
8AF3000014	<b>Z-GRC-LS-And-300</b>	8AF	<b>1.678,00 €</b>	8AF3000012	<b>Z-GRC-LS-ZM-300</b>	8AF	<b>1.678,00 €</b>
8AF3100014	<b>Z-GRC-LS-And-310</b>	8AF	<b>1.702,00 €</b>	8AF3100012	<b>Z-GRC-LS-ZM-310</b>	8AF	<b>1.702,00 €</b>
8AF3150014	<b>Z-GRC-LS-And-315</b>	8AF	<b>1.702,00 €</b>	8AF3150012	<b>Z-GRC-LS-ZM-315</b>	8AF	<b>1.702,00 €</b>

ANr.	Beschreibung	AGr.	Einzelpreis	ANr.	Beschreibung	AGr.	Einzelpreis
------	--------------	------	-------------	------	--------------	------	-------------

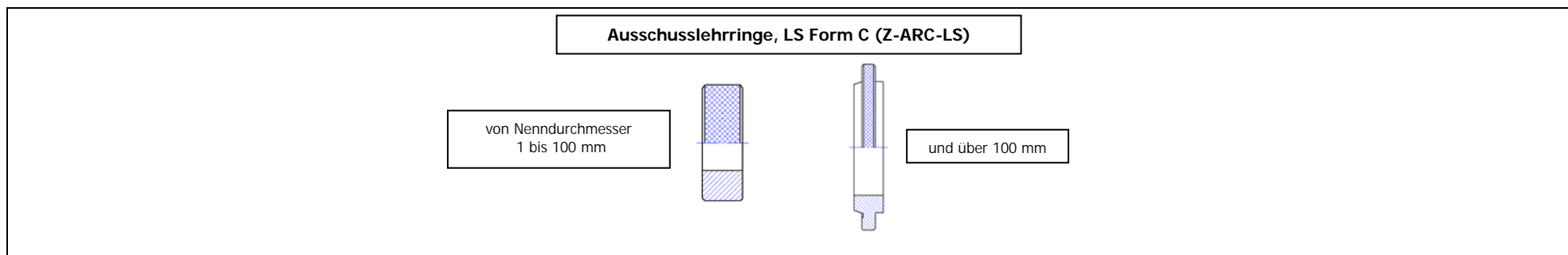

Ausschusslehrringe DIN 2254, Form C, ohne ZM				Ausschusslehrringe DIN 2254, Form C, mit ZM			
8AH0010014	Z-ARC-LS-And-1	8AH	218,00 €	8AH0010012	Z-ARC-LS-ZM-1	8AH	218,00 €
8AH0012014	Z-ARC-LS-And-1,2	8AH	218,00 €	8AH0012012	Z-ARC-LS-ZM-1,2	8AH	218,00 €
8AH0015014	Z-ARC-LS-And-1,5	8AH	218,00 €	8AH0015012	Z-ARC-LS-ZM-1,5	8AH	218,00 €
8AH0018014	Z-ARC-LS-And-1,8	8AH	218,00 €	8AH0018012	Z-ARC-LS-ZM-1,8	8AH	218,00 €
8AH0020014	Z-ARC-LS-And-2	8AH	186,00 €	8AH0020012	Z-ARC-LS-ZM-2	8AH	186,00 €
8AH0022014	Z-ARC-LS-And-2,2	8AH	194,00 €	8AH0022012	Z-ARC-LS-ZM-2,2	8AH	194,00 €
8AH0025014	Z-ARC-LS-And-2,5	8AH	197,00 €	8AH0025012	Z-ARC-LS-ZM-2,5	8AH	197,00 €
8AH0028014	Z-ARC-LS-And-2,8	8AH	197,00 €	8AH0028012	Z-ARC-LS-ZM-2,8	8AH	197,00 €
8AH0030014	Z-ARC-LS-And-3	8AH	81,00 €	8AH0030012	Z-ARC-LS-ZM-3	8AH	81,00 €
8AH0035014	Z-ARC-LS-And-3,5	8AH	80,00 €	8AH0035012	Z-ARC-LS-ZM-3,5	8AH	81,00 €
8AH0040014	Z-ARC-LS-And-4	8AH	80,00 €	8AH0040012	Z-ARC-LS-ZM-4	8AH	80,00 €
8AH0045014	Z-ARC-LS-And-4,5	8AH	80,00 €	8AH0045012	Z-ARC-LS-ZM-4,5	8AH	80,00 €
8AH0050014	Z-ARC-LS-And-5	8AH	78,00 €	8AH0050012	Z-ARC-LS-ZM-5	8AH	78,00 €
8AH0060014	Z-ARC-LS-And-6	8AH	77,00 €	8AH0060012	Z-ARC-LS-ZM-6	8AH	77,00 €
8AH0070014	Z-ARC-LS-And-7	8AH	77,00 €	8AH0070012	Z-ARC-LS-ZM-7	8AH	77,00 €
8AH0080014	Z-ARC-LS-And-8	8AH	77,00 €	8AH0080012	Z-ARC-LS-ZM-8	8AH	77,00 €
8AH0090014	Z-ARC-LS-And-9	8AH	77,00 €	8AH0090012	Z-ARC-LS-ZM-9	8AH	77,00 €
8AH0100014	Z-ARC-LS-And-10	8AH	77,00 €	8AH0100012	Z-ARC-LS-ZM-10	8AH	77,00 €
8AH0110014	Z-ARC-LS-And-11	8AH	78,00 €	8AH0110012	Z-ARC-LS-ZM-11	8AH	78,00 €
8AH0120014	Z-ARC-LS-And-12	8AH	81,00 €	8AH0120012	Z-ARC-LS-ZM-12	8AH	81,00 €
8AH0130014	Z-ARC-LS-And-13	8AH	81,00 €	8AH0130012	Z-ARC-LS-ZM-13	8AH	81,00 €
8AH0140014	Z-ARC-LS-And-14	8AH	81,00 €	8AH0140012	Z-ARC-LS-ZM-14	8AH	81,00 €
8AH0150014	Z-ARC-LS-And-15	8AH	83,00 €	8AH0150012	Z-ARC-LS-ZM-15	8AH	83,00 €
8AH0160014	Z-ARC-LS-And-16	8AH	84,00 €	8AH0160012	Z-ARC-LS-ZM-16	8AH	84,00 €
8AH0170014	Z-ARC-LS-And-17	8AH	86,00 €	8AH0170012	Z-ARC-LS-ZM-17	8AH	86,00 €
8AH0180014	Z-ARC-LS-And-18	8AH	86,00 €	8AH0180012	Z-ARC-LS-ZM-18	8AH	86,00 €
8AH0190014	Z-ARC-LS-And-19	8AH	88,00 €	8AH0190012	Z-ARC-LS-ZM-19	8AH	88,00 €
8AH0200014	Z-ARC-LS-And-20	8AH	89,00 €	8AH0200012	Z-ARC-LS-ZM-20	8AH	89,00 €
8AH0210014	Z-ARC-LS-And-21	8AH	89,00 €	8AH0210012	Z-ARC-LS-ZM-21	8AH	89,00 €

ANr.	Beschreibung	AGr.	Einzelpreis	ANr.	Beschreibung	AGr.	Einzelpreis
<b>Ausschusslehrringe DIN 2254, Form C, ohne ZM</b>				<b>Ausschusslehrringe DIN 2254, Form C, mit ZM</b>			
8AH0220014	Z-ARC-LS-And-22	8AH	91,00 €	8AH0220012	Z-ARC-LS-ZM-22	8AH	91,00 €
8AH0230014	Z-ARC-LS-And-23	8AH	93,00 €	8AH0230012	Z-ARC-LS-ZM-23	8AH	93,00 €
8AH0240014	Z-ARC-LS-And-24	8AH	94,00 €	8AH0240012	Z-ARC-LS-ZM-24	8AH	94,00 €
8AH0250014	Z-ARC-LS-And-25	8AH	96,00 €	8AH0250012	Z-ARC-LS-ZM-25	8AH	96,00 €
8AH0260014	Z-ARC-LS-And-26	8AH	97,00 €	8AH0260012	Z-ARC-LS-ZM-26	8AH	97,00 €
8AH0270014	Z-ARC-LS-And-27	8AH	97,00 €	8AH0270012	Z-ARC-LS-ZM-27	8AH	97,00 €
8AH0280014	Z-ARC-LS-And-28	8AH	97,00 €	8AH0280012	Z-ARC-LS-ZM-28	8AH	97,00 €
8AH0290014	Z-ARC-LS-And-29	8AH	102,00 €	8AH0290012	Z-ARC-LS-ZM-29	8AH	102,00 €
8AH0300014	Z-ARC-LS-And-30	8AH	102,00 €	8AH0300012	Z-ARC-LS-ZM-30	8AH	102,00 €
8AH0310014	Z-ARC-LS-And-31	8AH	104,00 €	8AH0310012	Z-ARC-LS-ZM-31	8AH	104,00 €
8AH0320014	Z-ARC-LS-And-32	8AH	104,00 €	8AH0320012	Z-ARC-LS-ZM-32	8AH	104,00 €
8AH0330014	Z-ARC-LS-And-33	8AH	106,00 €	8AH0330012	Z-ARC-LS-ZM-33	8AH	106,00 €
8AH0340014	Z-ARC-LS-And-34	8AH	107,00 €	8AH0340012	Z-ARC-LS-ZM-34	8AH	107,00 €
8AH0350014	Z-ARC-LS-And-35	8AH	107,00 €	8AH0350012	Z-ARC-LS-ZM-35	8AH	107,00 €
8AH0360014	Z-ARC-LS-And-36	8AH	109,00 €	8AH0360012	Z-ARC-LS-ZM-36	8AH	109,00 €
8AH0370014	Z-ARC-LS-And-37	8AH	110,00 €	8AH0370012	Z-ARC-LS-ZM-37	8AH	110,00 €
8AH0380014	Z-ARC-LS-And-38	8AH	112,00 €	8AH0380012	Z-ARC-LS-ZM-38	8AH	112,00 €
8AH0390014	Z-ARC-LS-And-39	8AH	118,00 €	8AH0390012	Z-ARC-LS-ZM-39	8AH	118,00 €
8AH0400014	Z-ARC-LS-And-40	8AH	118,00 €	8AH0400012	Z-ARC-LS-ZM-40	8AH	118,00 €
8AH0410014	Z-ARC-LS-And-41	8AH	125,00 €	8AH0410012	Z-ARC-LS-ZM-41	8AH	125,00 €
8AH0420014	Z-ARC-LS-And-42	8AH	125,00 €	8AH0420012	Z-ARC-LS-ZM-42	8AH	125,00 €
8AH0430014	Z-ARC-LS-And-43	8AH	128,00 €	8AH0430012	Z-ARC-LS-ZM-43	8AH	128,00 €
8AH0440014	Z-ARC-LS-And-44	8AH	128,00 €	8AH0440012	Z-ARC-LS-ZM-44	8AH	128,00 €
8AH0450014	Z-ARC-LS-And-45	8AH	131,00 €	8AH0450012	Z-ARC-LS-ZM-45	8AH	131,00 €
8AH0460014	Z-ARC-LS-And-46	8AH	135,00 €	8AH0460012	Z-ARC-LS-ZM-46	8AH	135,00 €
8AH0470014	Z-ARC-LS-And-47	8AH	138,00 €	8AH0470012	Z-ARC-LS-ZM-47	8AH	138,00 €
8AH0480014	Z-ARC-LS-And-48	8AH	144,00 €	8AH0480012	Z-ARC-LS-ZM-48	8AH	144,00 €
8AH0490014	Z-ARC-LS-And-49	8AH	149,00 €	8AH0490012	Z-ARC-LS-ZM-49	8AH	149,00 €
8AH0500014	Z-ARC-LS-And-50	8AH	149,00 €	8AH0500012	Z-ARC-LS-ZM-50	8AH	149,00 €
8AH0520014	Z-ARC-LS-And-52	8AH	159,00 €	8AH0520012	Z-ARC-LS-ZM-52	8AH	159,00 €
8AH0540014	Z-ARC-LS-And-54	8AH	168,00 €	8AH0540012	Z-ARC-LS-ZM-54	8AH	168,00 €
8AH0550014	Z-ARC-LS-And-55	8AH	168,00 €	8AH0550012	Z-ARC-LS-ZM-55	8AH	168,00 €
8AH0560014	Z-ARC-LS-And-56	8AH	175,00 €	8AH0560012	Z-ARC-LS-ZM-56	8AH	175,00 €
8AH0580014	Z-ARC-LS-And-58	8AH	175,00 €	8AH0580012	Z-ARC-LS-ZM-58	8AH	175,00 €
8AH0600014	Z-ARC-LS-And-60	8AH	181,00 €	8AH0600012	Z-ARC-LS-ZM-60	8AH	181,00 €
8AH0620014	Z-ARC-LS-And-62	8AH	193,00 €	8AH0620012	Z-ARC-LS-ZM-62	8AH	193,00 €
8AH0640014	Z-ARC-LS-And-64	8AH	204,00 €	8AH0640012	Z-ARC-LS-ZM-64	8AH	204,00 €
8AH0650014	Z-ARC-LS-And-65	8AH	204,00 €	8AH0650012	Z-ARC-LS-ZM-65	8AH	204,00 €
8AH0660014	Z-ARC-LS-And-66	8AH	212,00 €	8AH0660012	Z-ARC-LS-ZM-66	8AH	212,00 €
8AH0680014	Z-ARC-LS-And-68	8AH	212,00 €	8AH0680012	Z-ARC-LS-ZM-68	8AH	212,00 €
8AH0700014	Z-ARC-LS-And-70	8AH	220,00 €	8AH0700012	Z-ARC-LS-ZM-70	8AH	220,00 €
8AH0720014	Z-ARC-LS-And-72	8AH	230,00 €	8AH0720012	Z-ARC-LS-ZM-72	8AH	230,00 €
8AH0740014	Z-ARC-LS-And-74	8AH	241,00 €	8AH0740012	Z-ARC-LS-ZM-74	8AH	241,00 €
8AH0750014	Z-ARC-LS-And-75	8AH	241,00 €	8AH0750012	Z-ARC-LS-ZM-75	8AH	241,00 €

ANr.	Beschreibung	AGr.	Einzelpreis	ANr.	Beschreibung	AGr.	Einzelpreis
<b>Ausschusslehrringe DIN 2254, Form C, ohne ZM</b>				<b>Ausschusslehrringe DIN 2254, Form C, mit ZM</b>			
8AH0760014	Z-ARC-LS-And-76	8AH	249,00 €	8AH0760012	Z-ARC-LS-ZM-76	8AH	249,00 €
8AH0780014	Z-ARC-LS-And-78	8AH	249,00 €	8AH0780012	Z-ARC-LS-ZM-78	8AH	249,00 €
8AH0800014	Z-ARC-LS-And-80	8AH	262,00 €	8AH0800012	Z-ARC-LS-ZM-80	8AH	262,00 €
8AH0820014	Z-ARC-LS-And-82	8AH	280,00 €	8AH0820012	Z-ARC-LS-ZM-82	8AH	280,00 €
8AH0840014	Z-ARC-LS-And-84	8AH	299,00 €	8AH0840012	Z-ARC-LS-ZM-84	8AH	299,00 €
8AH0850014	Z-ARC-LS-And-85	8AH	299,00 €	8AH0850012	Z-ARC-LS-ZM-85	8AH	299,00 €
8AH0860014	Z-ARC-LS-And-86	8AH	312,00 €	8AH0860012	Z-ARC-LS-ZM-86	8AH	312,00 €
8AH0880014	Z-ARC-LS-And-88	8AH	312,00 €	8AH0880012	Z-ARC-LS-ZM-88	8AH	312,00 €
8AH0900014	Z-ARC-LS-And-90	8AH	323,00 €	8AH0900012	Z-ARC-LS-ZM-90	8AH	323,00 €
8AH0920014	Z-ARC-LS-And-92	8AH	342,00 €	8AH0920012	Z-ARC-LS-ZM-92	8AH	342,00 €
8AH0940014	Z-ARC-LS-And-94	8AH	360,00 €	8AH0940012	Z-ARC-LS-ZM-94	8AH	360,00 €
8AH0950014	Z-ARC-LS-And-95	8AH	360,00 €	8AH0950012	Z-ARC-LS-ZM-95	8AH	360,00 €
8AH0960014	Z-ARC-LS-And-96	8AH	373,00 €	8AH0960012	Z-ARC-LS-ZM-96	8AH	373,00 €
8AH0980014	Z-ARC-LS-And-98	8AH	373,00 €	8AH0980012	Z-ARC-LS-ZM-98	8AH	373,00 €
8AH1000014	Z-ARC-LS-And-100	8AH	393,00 €	8AH1000012	Z-ARC-LS-ZM-100	8AH	393,00 €
8AH1050014	Z-ARC-LS-And-105	8AH	410,00 €	8AH1050012	Z-ARC-LS-ZM-105	8AH	410,00 €
8AH1100014	Z-ARC-LS-And-110	8AH	430,00 €	8AH1100012	Z-ARC-LS-ZM-110	8AH	430,00 €
8AH1150014	Z-ARC-LS-And-115	8AH	447,00 €	8AH1150012	Z-ARC-LS-ZM-115	8AH	447,00 €
8AH1200014	Z-ARC-LS-And-120	8AH	467,00 €	8AH1200012	Z-ARC-LS-ZM-120	8AH	467,00 €
8AH1250014	Z-ARC-LS-And-125	8AH	484,00 €	8AH1250012	Z-ARC-LS-ZM-125	8AH	484,00 €
8AH1300014	Z-ARC-LS-And-130	8AH	504,00 €	8AH1300012	Z-ARC-LS-ZM-130	8AH	504,00 €
8AH1350014	Z-ARC-LS-And-135	8AH	522,00 €	8AH1350012	Z-ARC-LS-ZM-135	8AH	522,00 €
8AH1400014	Z-ARC-LS-And-140	8AH	541,00 €	8AH1400012	Z-ARC-LS-ZM-140	8AH	541,00 €
8AH1450014	Z-ARC-LS-And-145	8AH	560,00 €	8AH1450012	Z-ARC-LS-ZM-145	8AH	560,00 €
8AH1500014	Z-ARC-LS-And-150	8AH	610,00 €	8AH1500012	Z-ARC-LS-ZM-150	8AH	610,00 €
8AH1550014	Z-ARC-LS-And-155	8AH	662,00 €	8AH1550012	Z-ARC-LS-ZM-155	8AH	662,00 €
8AH1600014	Z-ARC-LS-And-160	8AH	712,00 €	8AH1600012	Z-ARC-LS-ZM-160	8AH	712,00 €
8AH1650014	Z-ARC-LS-And-165	8AH	764,00 €	8AH1650012	Z-ARC-LS-ZM-165	8AH	764,00 €
8AH1700014	Z-ARC-LS-And-170	8AH	813,00 €	8AH1700012	Z-ARC-LS-ZM-170	8AH	813,00 €
8AH1750014	Z-ARC-LS-And-175	8AH	865,00 €	8AH1750012	Z-ARC-LS-ZM-175	8AH	865,00 €
8AH1800014	Z-ARC-LS-And-180	8AH	917,00 €	8AH1800012	Z-ARC-LS-ZM-180	8AH	917,00 €
8AH1850014	Z-ARC-LS-And-185	8AH	967,00 €	8AH1850012	Z-ARC-LS-ZM-185	8AH	967,00 €
8AH1900014	Z-ARC-LS-And-190	8AH	1.018,00 €	8AH1900012	Z-ARC-LS-ZM-190	8AH	1.018,00 €
8AH1950014	Z-ARC-LS-And-195	8AH	1.068,00 €	8AH1950012	Z-ARC-LS-ZM-195	8AH	1.068,00 €
8AH2000014	Z-ARC-LS-And-200	8AH	1.123,00 €	8AH2000012	Z-ARC-LS-ZM-200	8AH	1.123,00 €
8AH2050014	Z-ARC-LS-And-205	8AH	1.178,00 €	8AH2050012	Z-ARC-LS-ZM-205	8AH	1.178,00 €
8AH2100014	Z-ARC-LS-And-210	8AH	1.178,00 €	8AH2100012	Z-ARC-LS-ZM-210	8AH	1.178,00 €
8AH2150014	Z-ARC-LS-And-215	8AH	1.233,00 €	8AH2150012	Z-ARC-LS-ZM-215	8AH	1.233,00 €
8AH2200014	Z-ARC-LS-And-220	8AH	1.233,00 €	8AH2200012	Z-ARC-LS-ZM-220	8AH	1.233,00 €
8AH2250014	Z-ARC-LS-And-225	8AH	1.079,00 €	8AH2250012	Z-ARC-LS-ZM-225	8AH	1.288,00 €
8AH2300014	Z-ARC-LS-And-230	8AH	1.288,00 €	8AH2300012	Z-ARC-LS-ZM-230	8AH	1.288,00 €
8AH2400014	Z-ARC-LS-And-240	8AH	1.342,00 €	8AH2400012	Z-ARC-LS-ZM-240	8AH	1.342,00 €
8AH2500014	Z-ARC-LS-And-250	8AH	1.396,00 €	8AH2500012	Z-ARC-LS-ZM-250	8AH	1.396,00 €
8AH2600014	Z-ARC-LS-And-260	8AH	1.451,00 €	8AH2600012	Z-ARC-LS-ZM-260	8AH	1.451,00 €

ANr.	Beschreibung	AGr.	Einzelpreis	ANr.	Beschreibung	AGr.	Einzelpreis
<b>Ausschusslehrringe DIN 2254, Form C, ohne ZM</b>				<b>Ausschusslehrringe DIN 2254, Form C, mit ZM</b>			
8AH2700014	<b>Z-ARC-LS-And-270</b>	8AH	<b>1.505,00 €</b>	8AH2700012	<b>Z-ARC-LS-ZM-270</b>	8AH	<b>1.505,00 €</b>
8AH2750014	<b>Z-ARC-LS-And-275</b>	8AH	<b>1.560,00 €</b>	8AH2750012	<b>Z-ARC-LS-ZM-275</b>	8AH	<b>1.560,00 €</b>
8AH2800014	<b>Z-ARC-LS-And-280</b>	8AH	<b>1.560,00 €</b>	8AH2800012	<b>Z-ARC-LS-ZM-280</b>	8AH	<b>1.560,00 €</b>
8AH2900014	<b>Z-ARC-LS-And-290</b>	8AH	<b>1.615,00 €</b>	8AH2900012	<b>Z-ARC-LS-ZM-290</b>	8AH	<b>1.615,00 €</b>
8AH3000014	<b>Z-ARC-LS-And-300</b>	8AH	<b>1.678,00 €</b>	8AH3000012	<b>Z-ARC-LS-ZM-300</b>	8AH	<b>1.678,00 €</b>
8AH3100014	<b>Z-ARC-LS-And-310</b>	8AH	<b>1.702,00 €</b>	8AH3100012	<b>Z-ARC-LS-ZM-310</b>	8AH	<b>1.702,00 €</b>
8AH3150014	<b>Z-ARC-LS-And-315</b>	8AH	<b>1.702,00 €</b>	8AH3150012	<b>Z-ARC-LS-ZM-315</b>	8AH	<b>1.702,00 €</b>

ANr.	Beschreibung	AGr.	Einzelpreis	ANr.	Beschreibung	AGr.	Einzelpreis
------	--------------	------	-------------	------	--------------	------	-------------

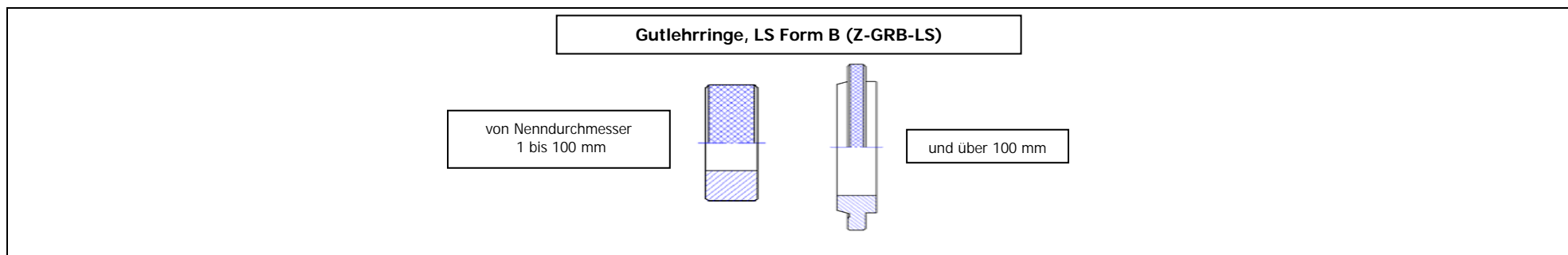

Gutlehringe DIN 2250, Form B, ohne ZM				Gutlehringe DIN 2250, Form B, mit ZM			
8AG0010014	Z-GRB-LS-And-1	8AG	312,00 €	8AG0010012	Z-GRB-LS-ZM-1	8AG	312,00 €
8AG0012014	Z-GRB-LS-And-1,2	8AG	324,00 €	8AG0012012	Z-GRB-LS-ZM-1,2	8AG	324,00 €
8AG0015014	Z-GRB-LS-And-1,5	8AG	324,00 €	8AG0015012	Z-GRB-LS-ZM-1,5	8AG	324,00 €
8AG0018014	Z-GRB-LS-And-1,8	8AG	324,00 €	8AG0018012	Z-GRB-LS-ZM-1,8	8AG	324,00 €
8AG0020014	Z-GRB-LS-And-2	8AG	264,00 €	8AG0020012	Z-GRB-LS-ZM-2	8AG	264,00 €
8AG0022014	Z-GRB-LS-And-2,2	8AG	276,00 €	8AG0022012	Z-GRB-LS-ZM-2,2	8AG	276,00 €
8AG0025014	Z-GRB-LS-And-2,5	8AG	288,00 €	8AG0025012	Z-GRB-LS-ZM-2,5	8AG	288,00 €
8AG0028014	Z-GRB-LS-And-2,8	8AG	293,00 €	8AG0028012	Z-GRB-LS-ZM-2,8	8AG	293,00 €
8AG0030014	Z-GRB-LS-And-3	8AG	120,00 €	8AG0030012	Z-GRB-LS-ZM-3	8AG	120,00 €
8AG0035014	Z-GRB-LS-And-3,5	8AG	118,00 €	8AG0035012	Z-GRB-LS-ZM-3,5	8AG	118,00 €
8AG0040014	Z-GRB-LS-And-4	8AG	118,00 €	8AG0040012	Z-GRB-LS-ZM-4	8AG	118,00 €
8AG0045014	Z-GRB-LS-And-4,5	8AG	118,00 €	8AG0045012	Z-GRB-LS-ZM-4,5	8AG	118,00 €
8AG0050014	Z-GRB-LS-And-5	8AG	116,00 €	8AG0050012	Z-GRB-LS-ZM-5	8AG	116,00 €
8AG0060014	Z-GRB-LS-And-6	8AG	113,00 €	8AG0060012	Z-GRB-LS-ZM-6	8AG	113,00 €
8AG0070014	Z-GRB-LS-And-7	8AG	113,00 €	8AG0070012	Z-GRB-LS-ZM-7	8AG	113,00 €
8AG0080014	Z-GRB-LS-And-8	8AG	113,00 €	8AG0080012	Z-GRB-LS-ZM-8	8AG	113,00 €
8AG0090014	Z-GRB-LS-And-9	8AG	113,00 €	8AG0090012	Z-GRB-LS-ZM-9	8AG	113,00 €
8AG0100014	Z-GRB-LS-And-10	8AG	113,00 €	8AG0100012	Z-GRB-LS-ZM-10	8AG	113,00 €
8AG0110014	Z-GRB-LS-And-11	8AG	116,00 €	8AG0110012	Z-GRB-LS-ZM-11	8AG	116,00 €
8AG0120014	Z-GRB-LS-And-12	8AG	118,00 €	8AG0120012	Z-GRB-LS-ZM-12	8AG	118,00 €
8AG0130014	Z-GRB-LS-And-13	8AG	120,00 €	8AG0130012	Z-GRB-LS-ZM-13	8AG	120,00 €
8AG0140014	Z-GRB-LS-And-14	8AG	120,00 €	8AG0140012	Z-GRB-LS-ZM-14	8AG	120,00 €
8AG0150014	Z-GRB-LS-And-15	8AG	123,00 €	8AG0150012	Z-GRB-LS-ZM-15	8AG	123,00 €
8AG0160014	Z-GRB-LS-And-16	8AG	125,00 €	8AG0160012	Z-GRB-LS-ZM-16	8AG	125,00 €
8AG0170014	Z-GRB-LS-And-17	8AG	127,00 €	8AG0170012	Z-GRB-LS-ZM-17	8AG	127,00 €
8AG0180014	Z-GRB-LS-And-18	8AG	127,00 €	8AG0180012	Z-GRB-LS-ZM-18	8AG	127,00 €
8AG0190014	Z-GRB-LS-And-19	8AG	130,00 €	8AG0190012	Z-GRB-LS-ZM-19	8AG	130,00 €
8AG0200014	Z-GRB-LS-And-20	8AG	133,00 €	8AG0200012	Z-GRB-LS-ZM-20	8AG	133,00 €
8AG0210014	Z-GRB-LS-And-21	8AG	135,00 €	8AG0210012	Z-GRB-LS-ZM-21	8AG	135,00 €
8AG0220014	Z-GRB-LS-And-22	8AG	135,00 €	8AG0220012	Z-GRB-LS-ZM-22	8AG	135,00 €



ANr.	Beschreibung	AGr.	Einzelpreis	ANr.	Beschreibung	AGr.	Einzelpreis
<b>Gutlehrringe DIN 2250, Form B, ohne ZM</b>				<b>Gutlehrringe DIN 2250, Form B, mit ZM</b>			
8AG0230014	Z-GRB-LS-And-23	8AG	137,00 €	8AG0230012	Z-GRB-LS-ZM-23	8AG	137,00 €
8AG0240014	Z-GRB-LS-And-24	8AG	140,00 €	8AG0240012	Z-GRB-LS-ZM-24	8AG	140,00 €
8AG0250014	Z-GRB-LS-And-25	8AG	142,00 €	8AG0250012	Z-GRB-LS-ZM-25	8AG	142,00 €
8AG0260014	Z-GRB-LS-And-26	8AG	144,00 €	8AG0260012	Z-GRB-LS-ZM-26	8AG	144,00 €
8AG0270014	Z-GRB-LS-And-27	8AG	144,00 €	8AG0270012	Z-GRB-LS-ZM-27	8AG	144,00 €
8AG0280014	Z-GRB-LS-And-28	8AG	149,00 €	8AG0280012	Z-GRB-LS-ZM-28	8AG	149,00 €
8AG0290014	Z-GRB-LS-And-29	8AG	152,00 €	8AG0290012	Z-GRB-LS-ZM-29	8AG	152,00 €
8AG0300014	Z-GRB-LS-And-30	8AG	152,00 €	8AG0300012	Z-GRB-LS-ZM-30	8AG	152,00 €
8AG0310014	Z-GRB-LS-And-31	8AG	154,00 €	8AG0310012	Z-GRB-LS-ZM-31	8AG	154,00 €
8AG0320014	Z-GRB-LS-And-32	8AG	154,00 €	8AG0320012	Z-GRB-LS-ZM-32	8AG	154,00 €
8AG0330014	Z-GRB-LS-And-33	8AG	156,00 €	8AG0330012	Z-GRB-LS-ZM-33	8AG	156,00 €
8AG0340014	Z-GRB-LS-And-34	8AG	156,00 €	8AG0340012	Z-GRB-LS-ZM-34	8AG	156,00 €
8AG0350014	Z-GRB-LS-And-35	8AG	159,00 €	8AG0350012	Z-GRB-LS-ZM-35	8AG	159,00 €
8AG0360014	Z-GRB-LS-And-36	8AG	161,00 €	8AG0360012	Z-GRB-LS-ZM-36	8AG	161,00 €
8AG0370014	Z-GRB-LS-And-37	8AG	163,00 €	8AG0370012	Z-GRB-LS-ZM-37	8AG	163,00 €
8AG0380014	Z-GRB-LS-And-38	8AG	166,00 €	8AG0380012	Z-GRB-LS-ZM-38	8AG	166,00 €
8AG0390014	Z-GRB-LS-And-39	8AG	176,00 €	8AG0390012	Z-GRB-LS-ZM-39	8AG	176,00 €
8AG0400014	Z-GRB-LS-And-40	8AG	176,00 €	8AG0400012	Z-GRB-LS-ZM-40	8AG	176,00 €
8AG0410014	Z-GRB-LS-And-41	8AG	185,00 €	8AG0410012	Z-GRB-LS-ZM-41	8AG	185,00 €
8AG0420014	Z-GRB-LS-And-42	8AG	185,00 €	8AG0420012	Z-GRB-LS-ZM-42	8AG	185,00 €
8AG0430014	Z-GRB-LS-And-43	8AG	190,00 €	8AG0430012	Z-GRB-LS-ZM-43	8AG	190,00 €
8AG0440014	Z-GRB-LS-And-44	8AG	190,00 €	8AG0440012	Z-GRB-LS-ZM-44	8AG	190,00 €
8AG0450014	Z-GRB-LS-And-45	8AG	195,00 €	8AG0450012	Z-GRB-LS-ZM-45	8AG	195,00 €
8AG0460014	Z-GRB-LS-And-46	8AG	199,00 €	8AG0460012	Z-GRB-LS-ZM-46	8AG	199,00 €
8AG0470014	Z-GRB-LS-And-47	8AG	204,00 €	8AG0470012	Z-GRB-LS-ZM-47	8AG	204,00 €
8AG0480014	Z-GRB-LS-And-48	8AG	214,00 €	8AG0480012	Z-GRB-LS-ZM-48	8AG	214,00 €
8AG0490014	Z-GRB-LS-And-49	8AG	221,00 €	8AG0490012	Z-GRB-LS-ZM-49	8AG	221,00 €
8AG0500014	Z-GRB-LS-And-50	8AG	236,00 €	8AG0500012	Z-GRB-LS-ZM-50	8AG	236,00 €
8AG0520014	Z-GRB-LS-And-52	8AG	236,00 €	8AG0520012	Z-GRB-LS-ZM-52	8AG	236,00 €
8AG0540014	Z-GRB-LS-And-54	8AG	250,00 €	8AG0540012	Z-GRB-LS-ZM-54	8AG	250,00 €
8AG0550014	Z-GRB-LS-And-55	8AG	250,00 €	8AG0550012	Z-GRB-LS-ZM-55	8AG	250,00 €
8AG0560014	Z-GRB-LS-And-56	8AG	259,00 €	8AG0560012	Z-GRB-LS-ZM-56	8AG	259,00 €
8AG0580014	Z-GRB-LS-And-58	8AG	259,00 €	8AG0580012	Z-GRB-LS-ZM-58	8AG	259,00 €
8AG0600014	Z-GRB-LS-And-60	8AG	269,00 €	8AG0600012	Z-GRB-LS-ZM-60	8AG	269,00 €
8AG0620014	Z-GRB-LS-And-62	8AG	286,00 €	8AG0620012	Z-GRB-LS-ZM-62	8AG	286,00 €
8AG0640014	Z-GRB-LS-And-64	8AG	302,00 €	8AG0640012	Z-GRB-LS-ZM-64	8AG	302,00 €
8AG0650014	Z-GRB-LS-And-65	8AG	302,00 €	8AG0650012	Z-GRB-LS-ZM-65	8AG	302,00 €
8AG0660014	Z-GRB-LS-And-66	8AG	314,00 €	8AG0660012	Z-GRB-LS-ZM-66	8AG	314,00 €
8AG0680014	Z-GRB-LS-And-68	8AG	314,00 €	8AG0680012	Z-GRB-LS-ZM-68	8AG	314,00 €
8AG0700014	Z-GRB-LS-And-70	8AG	326,00 €	8AG0700012	Z-GRB-LS-ZM-70	8AG	326,00 €
8AG0720014	Z-GRB-LS-And-72	8AG	341,00 €	8AG0720012	Z-GRB-LS-ZM-72	8AG	341,00 €
8AG0740014	Z-GRB-LS-And-74	8AG	357,00 €	8AG0740012	Z-GRB-LS-ZM-74	8AG	357,00 €
8AG0750014	Z-GRB-LS-And-75	8AG	357,00 €	8AG0750012	Z-GRB-LS-ZM-75	8AG	357,00 €
8AG0760014	Z-GRB-LS-And-76	8AG	369,00 €	8AG0760012	Z-GRB-LS-ZM-76	8AG	369,00 €

ANr.	Beschreibung	AGr.	Einzelpreis	ANr.	Beschreibung	AGr.	Einzelpreis
<b>Gutlehrringe DIN 2250, Form B, ohne ZM</b>				<b>Gutlehrringe DIN 2250, Form B, mit ZM</b>			
8AG0780014	<b>Z-GRB-LS-And-78</b>	8AG	<b>369,00 €</b>	8AG0780012	<b>Z-GRB-LS-ZM-78</b>	8AG	<b>369,00 €</b>
8AG0800014	<b>Z-GRB-LS-And-80</b>	8AG	<b>389,00 €</b>	8AG0800012	<b>Z-GRB-LS-ZM-80</b>	8AG	<b>389,00 €</b>
8AG0820014	<b>Z-GRB-LS-And-82</b>	8AG	<b>415,00 €</b>	8AG0820012	<b>Z-GRB-LS-ZM-82</b>	8AG	<b>415,00 €</b>
8AG0840014	<b>Z-GRB-LS-And-84</b>	8AG	<b>443,00 €</b>	8AG0840012	<b>Z-GRB-LS-ZM-84</b>	8AG	<b>443,00 €</b>
8AG0850014	<b>Z-GRB-LS-And-85</b>	8AG	<b>443,00 €</b>	8AG0850012	<b>Z-GRB-LS-ZM-85</b>	8AG	<b>443,00 €</b>
8AG0860014	<b>Z-GRB-LS-And-86</b>	8AG	<b>463,00 €</b>	8AG0860012	<b>Z-GRB-LS-ZM-86</b>	8AG	<b>463,00 €</b>
8AG0880014	<b>Z-GRB-LS-And-88</b>	8AG	<b>463,00 €</b>	8AG0880012	<b>Z-GRB-LS-ZM-88</b>	8AG	<b>463,00 €</b>
8AG0900014	<b>Z-GRB-LS-And-90</b>	8AG	<b>479,00 €</b>	8AG0900012	<b>Z-GRB-LS-ZM-90</b>	8AG	<b>479,00 €</b>
8AG0920014	<b>Z-GRB-LS-And-92</b>	8AG	<b>508,00 €</b>	8AG0920012	<b>Z-GRB-LS-ZM-92</b>	8AG	<b>508,00 €</b>
8AG0940014	<b>Z-GRB-LS-And-94</b>	8AG	<b>535,00 €</b>	8AG0940012	<b>Z-GRB-LS-ZM-94</b>	8AG	<b>535,00 €</b>
8AG0950014	<b>Z-GRB-LS-And-95</b>	8AG	<b>535,00 €</b>	8AG0950012	<b>Z-GRB-LS-ZM-95</b>	8AG	<b>535,00 €</b>
8AG0960014	<b>Z-GRB-LS-And-96</b>	8AG	<b>554,00 €</b>	8AG0960012	<b>Z-GRB-LS-ZM-96</b>	8AG	<b>554,00 €</b>
8AG0980014	<b>Z-GRB-LS-And-98</b>	8AG	<b>554,00 €</b>	8AG0980012	<b>Z-GRB-LS-ZM-98</b>	8AG	<b>554,00 €</b>
8AG1000014	<b>Z-GRB-LS-And-100</b>	8AG	<b>572,00 €</b>	8AG1000012	<b>Z-GRB-LS-ZM-100</b>	8AG	<b>572,00 €</b>

ANr.	Beschreibung	AGr.	Einzelpreis	ANr.	Beschreibung	AGr.	Einzelpreis
------	--------------	------	-------------	------	--------------	------	-------------

Grenzrachenlehren doppelmäutig, LS (Z-GRDLM-LS)

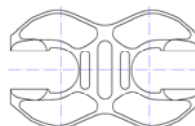

von Nenndurchmesser  
1 bis 100 mm

Grenzrachenlehren, doppelmäutig, ohne ZM				Grenzrachenlehren, doppelmäutig, mit ZM			
8AI0030014	Z-GRDLM-LS-And-3	8AI	153,00 €	8AI0030012	Z-GRDLM-LS-ZM-3	8AI	183,00 €
8AI0035014	Z-GRDLM-LS-And-3,5	8AI	148,00 €	8AI0035012	Z-GRDLM-LS-ZM-3,5	8AI	177,00 €
8AI0040014	Z-GRDLM-LS-And-4	8AI	148,00 €	8AI0040012	Z-GRDLM-LS-ZM-4	8AI	177,00 €
8AI0045014	Z-GRDLM-LS-And-4,5	8AI	148,00 €	8AI0045012	Z-GRDLM-LS-ZM-4,5	8AI	177,00 €
8AI0050014	Z-GRDLM-LS-And-5	8AI	148,00 €	8AI0050012	Z-GRDLM-LS-ZM-5	8AI	177,00 €
8AI0060014	Z-GRDLM-LS-And-6	8AI	148,00 €	8AI0060012	Z-GRDLM-LS-ZM-6	8AI	177,00 €
8AI0070014	Z-GRDLM-LS-And-7	8AI	134,00 €	8AI0070012	Z-GRDLM-LS-ZM-7	8AI	161,00 €
8AI0080014	Z-GRDLM-LS-And-8	8AI	134,00 €	8AI0080012	Z-GRDLM-LS-ZM-8	8AI	161,00 €
8AI0090014	Z-GRDLM-LS-And-9	8AI	134,00 €	8AI0090012	Z-GRDLM-LS-ZM-9	8AI	161,00 €
8AI0100014	Z-GRDLM-LS-And-10	8AI	134,00 €	8AI0100012	Z-GRDLM-LS-ZM-10	8AI	161,00 €
8AI0110014	Z-GRDLM-LS-And-11	8AI	142,00 €	8AI0110012	Z-GRDLM-LS-ZM-11	8AI	171,00 €
8AI0120014	Z-GRDLM-LS-And-12	8AI	142,00 €	8AI0120012	Z-GRDLM-LS-ZM-12	8AI	171,00 €
8AI0130014	Z-GRDLM-LS-And-13	8AI	142,00 €	8AI0130012	Z-GRDLM-LS-ZM-13	8AI	171,00 €
8AI0140014	Z-GRDLM-LS-And-14	8AI	142,00 €	8AI0140012	Z-GRDLM-LS-ZM-14	8AI	171,00 €
8AI0150014	Z-GRDLM-LS-And-15	8AI	150,00 €	8AI0150012	Z-GRDLM-LS-ZM-15	8AI	180,00 €
8AI0160014	Z-GRDLM-LS-And-16	8AI	150,00 €	8AI0160012	Z-GRDLM-LS-ZM-16	8AI	180,00 €
8AI0170014	Z-GRDLM-LS-And-17	8AI	150,00 €	8AI0170012	Z-GRDLM-LS-ZM-17	8AI	180,00 €
8AI0180014	Z-GRDLM-LS-And-18	8AI	150,00 €	8AI0180012	Z-GRDLM-LS-ZM-18	8AI	180,00 €
8AI0190014	Z-GRDLM-LS-And-19	8AI	164,00 €	8AI0190012	Z-GRDLM-LS-ZM-19	8AI	196,00 €
8AI0200014	Z-GRDLM-LS-And-20	8AI	164,00 €	8AI0200012	Z-GRDLM-LS-ZM-20	8AI	196,00 €
8AI0210014	Z-GRDLM-LS-And-21	8AI	164,00 €	8AI0210012	Z-GRDLM-LS-ZM-21	8AI	196,00 €
8AI0220014	Z-GRDLM-LS-And-22	8AI	164,00 €	8AI0220012	Z-GRDLM-LS-ZM-22	8AI	196,00 €
8AI0230014	Z-GRDLM-LS-And-23	8AI	166,00 €	8AI0230012	Z-GRDLM-LS-ZM-23	8AI	199,00 €
8AI0240014	Z-GRDLM-LS-And-24	8AI	166,00 €	8AI0240012	Z-GRDLM-LS-ZM-24	8AI	199,00 €
8AI0250014	Z-GRDLM-LS-And-25	8AI	166,00 €	8AI0250012	Z-GRDLM-LS-ZM-25	8AI	199,00 €
8AI0260014	Z-GRDLM-LS-And-26	8AI	166,00 €	8AI0260012	Z-GRDLM-LS-ZM-26	8AI	199,00 €
8AI0270014	Z-GRDLM-LS-And-27	8AI	166,00 €	8AI0270012	Z-GRDLM-LS-ZM-27	8AI	199,00 €
8AI0280014	Z-GRDLM-LS-And-28	8AI	169,00 €	8AI0280012	Z-GRDLM-LS-ZM-28	8AI	203,00 €
8AI0300014	Z-GRDLM-LS-And-30	8AI	169,00 €	8AI0300012	Z-GRDLM-LS-ZM-30	8AI	203,00 €

ANr.	Beschreibung	AGr.	Einzelpreis	ANr.	Beschreibung	AGr.	Einzelpreis
<b>Grenzrachenlehren, doppelmäulig, ohne ZM</b>				<b>Grenzrachenlehren, doppelmäulig, mit ZM</b>			
8AI0310014	Z-GRDLM-LS-And-31	8AI	169,00 €	8AI0310012	Z-GRDLM-LS-ZM-31	8AI	203,00 €
8AI0320014	Z-GRDLM-LS-And-32	8AI	116,00 €	8AI0320012	Z-GRDLM-LS-ZM-32	8AI	203,00 €
8AI0330014	Z-GRDLM-LS-And-33	8AI	177,00 €	8AI0330012	Z-GRDLM-LS-ZM-33	8AI	212,00 €
8AI0340014	Z-GRDLM-LS-And-34	8AI	177,00 €	8AI0340012	Z-GRDLM-LS-ZM-34	8AI	212,00 €
8AI0350014	Z-GRDLM-LS-And-35	8AI	177,00 €	8AI0350012	Z-GRDLM-LS-ZM-35	8AI	212,00 €
8AI0360014	Z-GRDLM-LS-And-36	8AI	177,00 €	8AI0360012	Z-GRDLM-LS-ZM-36	8AI	212,00 €
8AI0370014	Z-GRDLM-LS-And-37	8AI	177,00 €	8AI0370012	Z-GRDLM-LS-ZM-37	8AI	212,00 €
8AI0380014	Z-GRDLM-LS-And-38	8AI	177,00 €	8AI0380012	Z-GRDLM-LS-ZM-38	8AI	212,00 €
8AI0400014	Z-GRDLM-LS-And-40	8AI	188,00 €	8AI0400012	Z-GRDLM-LS-ZM-40	8AI	225,00 €
8AI0420014	Z-GRDLM-LS-And-42	8AI	188,00 €	8AI0420012	Z-GRDLM-LS-ZM-42	8AI	225,00 €
8AI0440014	Z-GRDLM-LS-And-44	8AI	201,00 €	8AI0440012	Z-GRDLM-LS-ZM-44	8AI	241,00 €
8AI0450014	Z-GRDLM-LS-And-45	8AI	201,00 €	8AI0450012	Z-GRDLM-LS-ZM-45	8AI	241,00 €
8AI0460014	Z-GRDLM-LS-And-46	8AI	201,00 €	8AI0460012	Z-GRDLM-LS-ZM-46	8AI	241,00 €
8AI0470014	Z-GRDLM-LS-And-47	8AI	201,00 €	8AI0470012	Z-GRDLM-LS-ZM-47	8AI	241,00 €
8AI0480014	Z-GRDLM-LS-And-48	8AI	201,00 €	8AI0480012	Z-GRDLM-LS-ZM-48	8AI	241,00 €
8AI0500014	Z-GRDLM-LS-And-50	8AI	214,00 €	8AI0500012	Z-GRDLM-LS-ZM-50	8AI	257,00 €
8AI0520014	Z-GRDLM-LS-And-52	8AI	214,00 €	8AI0520012	Z-GRDLM-LS-ZM-52	8AI	257,00 €
8AI0550014	Z-GRDLM-LS-And-55	8AI	214,00 €	8AI0550012	Z-GRDLM-LS-ZM-55	8AI	257,00 €
8AI0580014	Z-GRDLM-LS-And-58	8AI	233,00 €	8AI0580012	Z-GRDLM-LS-ZM-58	8AI	280,00 €
8AI0600014	Z-GRDLM-LS-And-60	8AI	233,00 €	8AI0600012	Z-GRDLM-LS-ZM-60	8AI	280,00 €
8AI0620014	Z-GRDLM-LS-And-62	8AI	233,00 €	8AI0620012	Z-GRDLM-LS-ZM-62	8AI	280,00 €
8AI0650014	Z-GRDLM-LS-And-65	8AI	255,00 €	8AI0650012	Z-GRDLM-LS-ZM-65	8AI	305,00 €
8AI0680014	Z-GRDLM-LS-And-68	8AI	255,00 €	8AI0680012	Z-GRDLM-LS-ZM-68	8AI	305,00 €
8AI0700014	Z-GRDLM-LS-And-70	8AI	255,00 €	8AI0700012	Z-GRDLM-LS-ZM-70	8AI	305,00 €
8AI0720014	Z-GRDLM-LS-And-72	8AI	276,00 €	8AI0720012	Z-GRDLM-LS-ZM-72	8AI	331,00 €
8AI0750014	Z-GRDLM-LS-And-75	8AI	276,00 €	8AI0750012	Z-GRDLM-LS-ZM-75	8AI	331,00 €
8AI0780014	Z-GRDLM-LS-And-78	8AI	300,00 €	8AI0780012	Z-GRDLM-LS-ZM-78	8AI	360,00 €
8AI0800014	Z-GRDLM-LS-And-80	8AI	300,00 €	8AI0800012	Z-GRDLM-LS-ZM-80	8AI	360,00 €
8AI0820014	Z-GRDLM-LS-And-82	8AI	300,00 €	8AI0820012	Z-GRDLM-LS-ZM-82	8AI	360,00 €
8AI0850014	Z-GRDLM-LS-And-85	8AI	308,00 €	8AI0850012	Z-GRDLM-LS-ZM-85	8AI	370,00 €
8AI0880014	Z-GRDLM-LS-And-88	8AI	308,00 €	8AI0880012	Z-GRDLM-LS-ZM-88	8AI	370,00 €
8AI0900014	Z-GRDLM-LS-And-90	8AI	308,00 €	8AI0900012	Z-GRDLM-LS-ZM-90	8AI	370,00 €
8AI0920014	Z-GRDLM-LS-And-92	8AI	308,00 €	8AI0920012	Z-GRDLM-LS-ZM-92	8AI	370,00 €
8AI0950014	Z-GRDLM-LS-And-95	8AI	321,00 €	8AI0950012	Z-GRDLM-LS-ZM-95	8AI	386,00 €
8AI0980014	Z-GRDLM-LS-And-98	8AI	321,00 €	8AI0980012	Z-GRDLM-LS-ZM-98	8AI	386,00 €
8AI1000014	Z-GRDLM-LS-And-100	8AI	321,00 €	8AI1000012	Z-GRDLM-LS-ZM-100	8AI	386,00 €

ANr.	Beschreibung	AGr.	Einzelpreis	ANr.	Beschreibung	AGr.	Einzelpreis
------	--------------	------	-------------	------	--------------	------	-------------

Grensrachenlehren einmäutig. LS (Z-GRLEM-LS)



von Nenndurchmesser  
3 bis 500 mm

Grensrachenlehren, einmäutig, ohne ZM				Grensrachenlehren, einmäutig, mit ZM			
8AJ0030014	Z-GRLEM-LS-And-3	8AJ	154,00 €	8AJ0030012	Z-GRLEM-LS-ZM-3	8AJ	185,00 €
8AJ0035014	Z-GRLEM-LS-And-3,5	8AJ	118,00 €	8AJ0035012	Z-GRLEM-LS-ZM-3,5	8AJ	142,00 €
8AJ0040014	Z-GRLEM-LS-And-4	8AJ	118,00 €	8AJ0040012	Z-GRLEM-LS-ZM-4	8AJ	142,00 €
8AJ0045014	Z-GRLEM-LS-And-4,5	8AJ	118,00 €	8AJ0045012	Z-GRLEM-LS-ZM-4,5	8AJ	142,00 €
8AJ0050014	Z-GRLEM-LS-And-5	8AJ	118,00 €	8AJ0050012	Z-GRLEM-LS-ZM-5	8AJ	142,00 €
8AJ0060014	Z-GRLEM-LS-And-6	8AJ	118,00 €	8AJ0060012	Z-GRLEM-LS-ZM-6	8AJ	142,00 €
8AJ0070014	Z-GRLEM-LS-And-7	8AJ	110,00 €	8AJ0070012	Z-GRLEM-LS-ZM-7	8AJ	132,00 €
8AJ0080014	Z-GRLEM-LS-And-8	8AJ	110,00 €	8AJ0080012	Z-GRLEM-LS-ZM-8	8AJ	132,00 €
8AJ0090014	Z-GRLEM-LS-And-9	8AJ	110,00 €	8AJ0090012	Z-GRLEM-LS-ZM-9	8AJ	132,00 €
8AJ0100014	Z-GRLEM-LS-And-10	8AJ	110,00 €	8AJ0100012	Z-GRLEM-LS-ZM-10	8AJ	132,00 €
8AJ0110014	Z-GRLEM-LS-And-11	8AJ	118,00 €	8AJ0110012	Z-GRLEM-LS-ZM-11	8AJ	142,00 €
8AJ0120014	Z-GRLEM-LS-And-12	8AJ	118,00 €	8AJ0120012	Z-GRLEM-LS-ZM-12	8AJ	142,00 €
8AJ0130014	Z-GRLEM-LS-And-13	8AJ	118,00 €	8AJ0130012	Z-GRLEM-LS-ZM-13	8AJ	142,00 €
8AJ0140014	Z-GRLEM-LS-And-14	8AJ	118,00 €	8AJ0140012	Z-GRLEM-LS-ZM-14	8AJ	142,00 €
8AJ0150014	Z-GRLEM-LS-And-15	8AJ	121,00 €	8AJ0150012	Z-GRLEM-LS-ZM-15	8AJ	145,00 €
8AJ0160014	Z-GRLEM-LS-And-16	8AJ	121,00 €	8AJ0160012	Z-GRLEM-LS-ZM-16	8AJ	145,00 €
8AJ0170014	Z-GRLEM-LS-And-17	8AJ	121,00 €	8AJ0170012	Z-GRLEM-LS-ZM-17	8AJ	145,00 €
8AJ0180014	Z-GRLEM-LS-And-18	8AJ	121,00 €	8AJ0180012	Z-GRLEM-LS-ZM-18	8AJ	145,00 €
8AJ0190014	Z-GRLEM-LS-And-19	8AJ	129,00 €	8AJ0190012	Z-GRLEM-LS-ZM-19	8AJ	155,00 €
8AJ0200014	Z-GRLEM-LS-And-20	8AJ	129,00 €	8AJ0200012	Z-GRLEM-LS-ZM-20	8AJ	155,00 €
8AJ0210014	Z-GRLEM-LS-And-21	8AJ	129,00 €	8AJ0210012	Z-GRLEM-LS-ZM-21	8AJ	155,00 €
8AJ0220014	Z-GRLEM-LS-And-22	8AJ	129,00 €	8AJ0220012	Z-GRLEM-LS-ZM-22	8AJ	155,00 €
8AJ0230014	Z-GRLEM-LS-And-23	8AJ	135,00 €	8AJ0230012	Z-GRLEM-LS-ZM-23	8AJ	162,00 €
8AJ0240014	Z-GRLEM-LS-And-24	8AJ	135,00 €	8AJ0240012	Z-GRLEM-LS-ZM-24	8AJ	162,00 €
8AJ0250014	Z-GRLEM-LS-And-25	8AJ	135,00 €	8AJ0250012	Z-GRLEM-LS-ZM-25	8AJ	162,00 €
8AJ0260014	Z-GRLEM-LS-And-26	8AJ	135,00 €	8AJ0260012	Z-GRLEM-LS-ZM-26	8AJ	162,00 €
8AJ0270014	Z-GRLEM-LS-And-27	8AJ	135,00 €	8AJ0270012	Z-GRLEM-LS-ZM-27	8AJ	162,00 €
8AJ0280014	Z-GRLEM-LS-And-28	8AJ	140,00 €	8AJ0280012	Z-GRLEM-LS-ZM-28	8AJ	168,00 €
8AJ0290014	Z-GRLEM-LS-And-29	8AJ	140,00 €	8AJ0290012	Z-GRLEM-LS-ZM-29	8AJ	168,00 €

ANr.	Beschreibung	AGr.	Einzelpreis	ANr.	Beschreibung	AGr.	Einzelpreis
<b>Grenzsachsenlehren, einmäutig, ohne ZM</b>				<b>Grenzsachsenlehren, einmäutig, mit ZM</b>			
8AJ0300014	Z-GRLEM-LS-And-30	8AJ	140,00 €	8AJ0300012	Z-GRLEM-LS-ZM-30	8AJ	168,00 €
8AJ0310014	Z-GRLEM-LS-And-31	8AJ	140,00 €	8AJ0310012	Z-GRLEM-LS-ZM-31	8AJ	168,00 €
8AJ0320014	Z-GRLEM-LS-And-32	8AJ	140,00 €	8AJ0320012	Z-GRLEM-LS-ZM-32	8AJ	168,00 €
8AJ0330014	Z-GRLEM-LS-And-33	8AJ	140,00 €	8AJ0330012	Z-GRLEM-LS-ZM-33	8AJ	168,00 €
8AJ0340014	Z-GRLEM-LS-And-34	8AJ	149,00 €	8AJ0340012	Z-GRLEM-LS-ZM-34	8AJ	178,00 €
8AJ0350014	Z-GRLEM-LS-And-35	8AJ	149,00 €	8AJ0350012	Z-GRLEM-LS-ZM-35	8AJ	178,00 €
8AJ0360014	Z-GRLEM-LS-And-36	8AJ	149,00 €	8AJ0360012	Z-GRLEM-LS-ZM-36	8AJ	178,00 €
8AJ0370014	Z-GRLEM-LS-And-37	8AJ	149,00 €	8AJ0370012	Z-GRLEM-LS-ZM-37	8AJ	178,00 €
8AJ0380014	Z-GRLEM-LS-And-38	8AJ	149,00 €	8AJ0380012	Z-GRLEM-LS-ZM-38	8AJ	178,00 €
8AJ0400014	Z-GRLEM-LS-And-40	8AJ	149,00 €	8AJ0400012	Z-GRLEM-LS-ZM-40	8AJ	178,00 €
8AJ0420014	Z-GRLEM-LS-And-42	8AJ	157,00 €	8AJ0420012	Z-GRLEM-LS-ZM-42	8AJ	188,00 €
8AJ0440014	Z-GRLEM-LS-And-44	8AJ	157,00 €	8AJ0440012	Z-GRLEM-LS-ZM-44	8AJ	187,00 €
8AJ0450014	Z-GRLEM-LS-And-45	8AJ	187,00 €	8AJ0450012	Z-GRLEM-LS-ZM-45	8AJ	224,00 €
8AJ0460014	Z-GRLEM-LS-And-46	8AJ	187,00 €	8AJ0460012	Z-GRLEM-LS-ZM-46	8AJ	224,00 €
8AJ0470014	Z-GRLEM-LS-And-47	8AJ	187,00 €	8AJ0470012	Z-GRLEM-LS-ZM-47	8AJ	224,00 €
8AJ0480014	Z-GRLEM-LS-And-48	8AJ	187,00 €	8AJ0480012	Z-GRLEM-LS-ZM-48	8AJ	224,00 €
8AJ0500014	Z-GRLEM-LS-And-50	8AJ	187,00 €	8AJ0500012	Z-GRLEM-LS-ZM-50	8AJ	224,00 €
8AJ0520014	Z-GRLEM-LS-And-52	8AJ	250,00 €	8AJ0520012	Z-GRLEM-LS-ZM-52	8AJ	300,00 €
8AJ0550014	Z-GRLEM-LS-And-55	8AJ	250,00 €	8AJ0550012	Z-GRLEM-LS-ZM-55	8AJ	300,00 €
8AJ0580014	Z-GRLEM-LS-And-58	8AJ	250,00 €	8AJ0580012	Z-GRLEM-LS-ZM-58	8AJ	300,00 €
8AJ0600014	Z-GRLEM-LS-And-60	8AJ	256,00 €	8AJ0600012	Z-GRLEM-LS-ZM-60	8AJ	307,00 €
8AJ0620014	Z-GRLEM-LS-And-62	8AJ	256,00 €	8AJ0620012	Z-GRLEM-LS-ZM-62	8AJ	307,00 €
8AJ0650014	Z-GRLEM-LS-And-65	8AJ	256,00 €	8AJ0650012	Z-GRLEM-LS-ZM-65	8AJ	307,00 €
8AJ0680014	Z-GRLEM-LS-And-68	8AJ	261,00 €	8AJ0680012	Z-GRLEM-LS-ZM-68	8AJ	313,00 €
8AJ0700014	Z-GRLEM-LS-And-70	8AJ	261,00 €	8AJ0700012	Z-GRLEM-LS-ZM-70	8AJ	313,00 €
8AJ0720014	Z-GRLEM-LS-And-72	8AJ	261,00 €	8AJ0720012	Z-GRLEM-LS-ZM-72	8AJ	313,00 €
8AJ0750014	Z-GRLEM-LS-And-75	8AJ	272,00 €	8AJ0750012	Z-GRLEM-LS-ZM-75	8AJ	326,00 €
8AJ0780014	Z-GRLEM-LS-And-78	8AJ	272,00 €	8AJ0780012	Z-GRLEM-LS-ZM-78	8AJ	326,00 €
8AJ0800014	Z-GRLEM-LS-And-80	8AJ	305,00 €	8AJ0800012	Z-GRLEM-LS-ZM-80	8AJ	366,00 €
8AJ0820014	Z-GRLEM-LS-And-82	8AJ	305,00 €	8AJ0820012	Z-GRLEM-LS-ZM-82	8AJ	366,00 €
8AJ0850014	Z-GRLEM-LS-And-85	8AJ	305,00 €	8AJ0850012	Z-GRLEM-LS-ZM-85	8AJ	366,00 €
8AJ0880014	Z-GRLEM-LS-And-88	8AJ	313,00 €	8AJ0880012	Z-GRLEM-LS-ZM-88	8AJ	376,00 €
8AJ0900014	Z-GRLEM-LS-And-90	8AJ	313,00 €	8AJ0900012	Z-GRLEM-LS-ZM-90	8AJ	376,00 €
8AJ0920014	Z-GRLEM-LS-And-92	8AJ	313,00 €	8AJ0920012	Z-GRLEM-LS-ZM-92	8AJ	376,00 €
8AJ0950014	Z-GRLEM-LS-And-95	8AJ	319,00 €	8AJ0950012	Z-GRLEM-LS-ZM-95	8AJ	382,00 €
8AJ0980014	Z-GRLEM-LS-And-98	8AJ	319,00 €	8AJ0980012	Z-GRLEM-LS-ZM-98	8AJ	382,00 €
8AJ1000014	Z-GRLEM-LS-And-100	8AJ	319,00 €	8AJ1000012	Z-GRLEM-LS-ZM-100	8AJ	382,00 €



ANr.	Beschreibung	AGr.	Einzelpreis	ANr.	Beschreibung	AGr.	Einzelpreis
<b>GrenZRachenlehren, einmäulig, ohne ZM</b>				<b>GrenZRachenlehren, einmäulig, mit ZM</b>			
8AJ1010014 bis 8AJ1100014	<b>Z-GRLEM-LS-And-101</b> <b>Z-GRLEM-LS-And-110</b>	8AJ 8AJ	<b>319,00 €</b> <b>319,00 €</b>	über 8AJ1000012 bis 8AJ1100012	<b>Z-GRLEM-LS-ZM-100</b> <b>Z-GRLEM-LS-ZM-110</b>	8AJ 8AJ	<b>382,00 €</b> <b>382,00 €</b>
8AJ1110014 bis 8AJ1250014	<b>Z-GRLEM-LS-And-111</b> <b>Z-GRLEM-LS-And-125</b>	8AJ 8AJ	<b>327,00 €</b> <b>327,00 €</b>	über 8AJ1100012 bis 8AJ1250012	<b>Z-GRLEM-LS-ZM-110</b> <b>Z-GRLEM-LS-ZM-125</b>	8AJ 8AJ	<b>392,00 €</b> <b>392,00 €</b>
8AJ1260014 bis 8AJ1400014	<b>Z-GRLEM-LS-And-126</b> <b>Z-GRLEM-LS-And-140</b>	8AJ 8AJ	<b>352,00 €</b> <b>352,00 €</b>	über 8AJ1250012 bis 8AJ1400012	<b>Z-GRLEM-LS-ZM-125</b> <b>Z-GRLEM-LS-ZM-140</b>	8AJ 8AJ	<b>422,00 €</b> <b>422,00 €</b>
8AJ1410014 bis 8AJ1550014	<b>Z-GRLEM-LS-And-141</b> <b>Z-GRLEM-LS-And-155</b>	8AJ 8AJ	<b>384,00 €</b> <b>384,00 €</b>	über 8AJ1400012 bis 8AJ1550012	<b>Z-GRLEM-LS-ZM-140</b> <b>Z-GRLEM-LS-ZM-155</b>	8AJ 8AJ	<b>461,00 €</b> <b>461,00 €</b>
8AJ1560014 bis 8AJ1700014	<b>Z-GRLEM-LS-And-156</b> <b>Z-GRLEM-LS-And-170</b>	8AJ 8AJ	<b>439,00 €</b> <b>439,00 €</b>	über 8AJ1550012 bis 8AJ1700012	<b>Z-GRLEM-LS-ZM-155</b> <b>Z-GRLEM-LS-ZM-170</b>	8AJ 8AJ	<b>527,00 €</b> <b>527,00 €</b>
8AJ1710014 bis 8AJ1850014	<b>Z-GRLEM-LS-And-171</b> <b>Z-GRLEM-LS-And-185</b>	8AJ 8AJ	<b>494,00 €</b> <b>494,00 €</b>	über 8AJ1700012 bis 8AJ1850012	<b>Z-GRLEM-LS-ZM-170</b> <b>Z-GRLEM-LS-ZM-185</b>	8AJ 8AJ	<b>593,00 €</b> <b>593,00 €</b>
8AJ1860014 bis 8AJ2000014	<b>Z-GRLEM-LS-And-186</b> <b>Z-GRLEM-LS-And-200</b>	8AJ 8AJ	<b>538,00 €</b> <b>538,00 €</b>	über 8AJ1850012 bis 8AJ2000012	<b>Z-GRLEM-LS-ZM-185</b> <b>Z-GRLEM-LS-ZM-200</b>	8AJ 8AJ	<b>646,00 €</b> <b>646,00 €</b>
8AJ2010014 bis 8AJ2140014	<b>Z-GRLEM-LS-And-201</b> <b>Z-GRLEM-LS-And-214</b>	8AJ 8AJ	<b>593,00 €</b> <b>593,00 €</b>	über 8AJ2000012 bis 8AJ2140012	<b>Z-GRLEM-LS-ZM-200</b> <b>Z-GRLEM-LS-ZM-214</b>	8AJ 8AJ	<b>712,00 €</b> <b>712,00 €</b>

ANr.	Beschreibung	AGr.	Einzelpreis	ANr.	Beschreibung	AGr.	Einzelpreis
------	--------------	------	-------------	------	--------------	------	-------------

**Flache Grenzlochlehren, LS (Z-FGRLL-LS)**

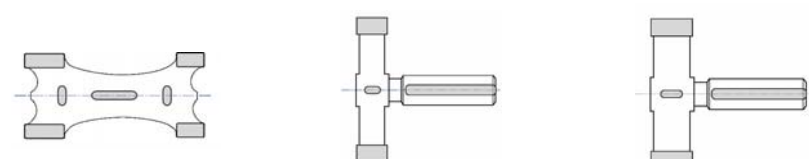

von Nenndurchmesser  
8 bis 100 mm

von Nenndurchmesser  
100 bis 200 mm

von Nenndurchmesser  
200 bis 500 mm

Flache Grenzlochlehren zum Lehren des I-Ø, ohne ZM				Flache Grenzlochlehren zum Lehren des I-Ø, mit ZM			
8AN0080014	Z-FGRLL-LS-And-8	8AN	83,00 €	8AN0080012	Z-FGRLL-LS-ZM-8	8AN	125,00 €
8AN0090014	Z-FGRLL-LS-And-9	8AN	83,00 €	8AN0090012	Z-FGRLL-LS-ZM-9	8AN	125,00 €
8AN0100014	Z-FGRLL-LS-And-10	8AN	83,00 €	8AN0100012	Z-FGRLL-LS-ZM-10	8AN	125,00 €
8AN0110014	Z-FGRLL-LS-And-11	8AN	83,00 €	8AN0110012	Z-FGRLL-LS-ZM-11	8AN	125,00 €
8AN0120014	Z-FGRLL-LS-And-12	8AN	83,00 €	8AN0120012	Z-FGRLL-LS-ZM-12	8AN	125,00 €
8AN0130014	Z-FGRLL-LS-And-13	8AN	83,00 €	8AN0130012	Z-FGRLL-LS-ZM-13	8AN	125,00 €
8AN0140014	Z-FGRLL-LS-And-14	8AN	83,00 €	8AN0140012	Z-FGRLL-LS-ZM-14	8AN	125,00 €
8AN0150014	Z-FGRLL-LS-And-15	8AN	83,00 €	8AN0150012	Z-FGRLL-LS-ZM-15	8AN	125,00 €
8AN0160014	Z-FGRLL-LS-And-16	8AN	86,00 €	8AN0160012	Z-FGRLL-LS-ZM-16	8AN	129,00 €
8AN0170014	Z-FGRLL-LS-And-17	8AN	86,00 €	8AN0170012	Z-FGRLL-LS-ZM-17	8AN	129,00 €
8AN0180014	Z-FGRLL-LS-And-18	8AN	86,00 €	8AN0180012	Z-FGRLL-LS-ZM-18	8AN	129,00 €
8AN0190014	Z-FGRLL-LS-And-19	8AN	86,00 €	8AN0190012	Z-FGRLL-LS-ZM-19	8AN	129,00 €
8AN0200014	Z-FGRLL-LS-And-20	8AN	86,00 €	8AN0200012	Z-FGRLL-LS-ZM-20	8AN	129,00 €
8AN0210014	Z-FGRLL-LS-And-21	8AN	86,00 €	8AN0210012	Z-FGRLL-LS-ZM-21	8AN	129,00 €
8AN0220014	Z-FGRLL-LS-And-22	8AN	86,00 €	8AN0220012	Z-FGRLL-LS-ZM-22	8AN	129,00 €
8AN0230014	Z-FGRLL-LS-And-23	8AN	86,00 €	8AN0230012	Z-FGRLL-LS-ZM-23	8AN	129,00 €
8AN0240014	Z-FGRLL-LS-And-24	8AN	86,00 €	8AN0240012	Z-FGRLL-LS-ZM-24	8AN	129,00 €
8AN0250014	Z-FGRLL-LS-And-25	8AN	92,00 €	8AN0250012	Z-FGRLL-LS-ZM-25	8AN	138,00 €
8AN0260014	Z-FGRLL-LS-And-26	8AN	92,00 €	8AN0260012	Z-FGRLL-LS-ZM-26	8AN	138,00 €
8AN0270014	Z-FGRLL-LS-And-27	8AN	92,00 €	8AN0270012	Z-FGRLL-LS-ZM-27	8AN	138,00 €
8AN0280014	Z-FGRLL-LS-And-28	8AN	92,00 €	8AN0280012	Z-FGRLL-LS-ZM-28	8AN	138,00 €
8AN0300014	Z-FGRLL-LS-And-30	8AN	98,00 €	8AN0300012	Z-FGRLL-LS-ZM-30	8AN	146,00 €
8AN0320014	Z-FGRLL-LS-And-32	8AN	98,00 €	8AN0320012	Z-FGRLL-LS-ZM-32	8AN	146,00 €
8AN0330014	Z-FGRLL-LS-And-33	8AN	98,00 €	8AN0330012	Z-FGRLL-LS-ZM-33	8AN	146,00 €
8AN0340014	Z-FGRLL-LS-And-34	8AN	98,00 €	8AN0340012	Z-FGRLL-LS-ZM-34	8AN	146,00 €
8AN0350014	Z-FGRLL-LS-And-35	8AN	98,00 €	8AN0350012	Z-FGRLL-LS-ZM-35	8AN	146,00 €
8AN0360014	Z-FGRLL-LS-And-36	8AN	103,00 €	8AN0360012	Z-FGRLL-LS-ZM-36	8AN	155,00 €
8AN0370014	Z-FGRLL-LS-And-37	8AN	103,00 €	8AN0370012	Z-FGRLL-LS-ZM-37	8AN	155,00 €
8AN0380014	Z-FGRLL-LS-And-38	8AN	103,00 €	8AN0380012	Z-FGRLL-LS-ZM-38	8AN	155,00 €

ANr.	Beschreibung	AGr.	Einzelpreis	ANr.	Beschreibung	AGr.	Einzelpreis
<b>Flache Grenzlochlehren zum Lehren des I-Ø, ohne ZM</b>				<b>Flache Grenzlochlehren zum Lehren des I-Ø, mit ZM</b>			
8AN0420014	Z-FGRLL-LS-And-42	8AN	109,00 €	8AN0420012	Z-FGRLL-LS-ZM-42	8AN	163,00 €
8AN0440014	Z-FGRLL-LS-And-44	8AN	109,00 €	8AN0440012	Z-FGRLL-LS-ZM-44	8AN	163,00 €
8AN0450014	Z-FGRLL-LS-And-45	8AN	109,00 €	8AN0450012	Z-FGRLL-LS-ZM-45	8AN	163,00 €
8AN0460014	Z-FGRLL-LS-And-46	8AN	109,00 €	8AN0460012	Z-FGRLL-LS-ZM-46	8AN	163,00 €
8AN0470014	Z-FGRLL-LS-And-47	8AN	109,00 €	8AN0470012	Z-FGRLL-LS-ZM-47	8AN	163,00 €
8AN0480014	Z-FGRLL-LS-And-48	8AN	109,00 €	8AN0480012	Z-FGRLL-LS-ZM-48	8AN	163,00 €
8AN0500014	Z-FGRLL-LS-And-50	8AN	118,00 €	8AN0500012	Z-FGRLL-LS-ZM-50	8AN	176,00 €
8AN0520014	Z-FGRLL-LS-And-52	8AN	118,00 €	8AN0520012	Z-FGRLL-LS-ZM-52	8AN	176,00 €
8AN0550014	Z-FGRLL-LS-And-55	8AN	118,00 €	8AN0550012	Z-FGRLL-LS-ZM-55	8AN	176,00 €
8AN0580014	Z-FGRLL-LS-And-58	8AN	126,00 €	8AN0580012	Z-FGRLL-LS-ZM-58	8AN	189,00 €
8AN0600014	Z-FGRLL-LS-And-60	8AN	126,00 €	8AN0600012	Z-FGRLL-LS-ZM-60	8AN	189,00 €
8AN0620014	Z-FGRLL-LS-And-62	8AN	126,00 €	8AN0620012	Z-FGRLL-LS-ZM-62	8AN	189,00 €
8AN0650014	Z-FGRLL-LS-And-65	8AN	135,00 €	8AN0650012	Z-FGRLL-LS-ZM-65	8AN	202,00 €
8AN0680014	Z-FGRLL-LS-And-68	8AN	135,00 €	8AN0680012	Z-FGRLL-LS-ZM-68	8AN	202,00 €
8AN0700014	Z-FGRLL-LS-And-70	8AN	135,00 €	8AN0700012	Z-FGRLL-LS-ZM-70	8AN	202,00 €
8AN0720014	Z-FGRLL-LS-And-72	8AN	146,00 €	8AN0720012	Z-FGRLL-LS-ZM-72	8AN	219,00 €
8AN0750014	Z-FGRLL-LS-And-75	8AN	146,00 €	8AN0750012	Z-FGRLL-LS-ZM-75	8AN	219,00 €
8AN0780014	Z-FGRLL-LS-And-78	8AN	146,00 €	8AN0780012	Z-FGRLL-LS-ZM-78	8AN	219,00 €
8AN0800014	Z-FGRLL-LS-And-80	8AN	146,00 €	8AN0800012	Z-FGRLL-LS-ZM-80	8AN	219,00 €
8AN0820014	Z-FGRLL-LS-And-82	8AN	158,00 €	8AN0820012	Z-FGRLL-LS-ZM-82	8AN	236,00 €
8AN0850014	Z-FGRLL-LS-And-85	8AN	158,00 €	8AN0850012	Z-FGRLL-LS-ZM-85	8AN	236,00 €
8AN0880014	Z-FGRLL-LS-And-88	8AN	158,00 €	8AN0880012	Z-FGRLL-LS-ZM-88	8AN	236,00 €
8AN0900014	Z-FGRLL-LS-And-90	8AN	172,00 €	8AN0900012	Z-FGRLL-LS-ZM-90	8AN	258,00 €
8AN0920014	Z-FGRLL-LS-And-92	8AN	172,00 €	8AN0920012	Z-FGRLL-LS-ZM-92	8AN	258,00 €
8AN0950014	Z-FGRLL-LS-And-95	8AN	172,00 €	8AN0950012	Z-FGRLL-LS-ZM-95	8AN	258,00 €
8AN0980014	Z-FGRLL-LS-And-98	8AN	172,00 €	8AN0980012	Z-FGRLL-LS-ZM-98	8AN	258,00 €
8AN1000014	Z-FGRLL-LS-And-100	8AN	172,00 €	8AN1000012	Z-FGRLL-LS-ZM-100	8AN	258,00 €

ANr.	Beschreibung	AGr.	Einzelpreis	ANr.	Beschreibung	AGr.	Einzelpreis
------	--------------	------	-------------	------	--------------	------	-------------

**Flache Gutlochlehren, LS (Z-FGLL-LS)**

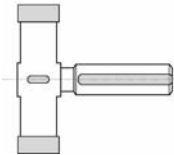

von Nenndurchmesser  
200 bis 500 mm

Flache Gutlochlehren zum Lehren des I-Ø, ohne ZM				Flache Gutlochlehren zum Lehren des I-Ø, mit ZM			
über 8AO1000014	<b>Z-FGLL-LS-And-100</b>	8AO	<b>286,00 €</b>	über 8AO1000012	<b>Z-FGLL-LS-ZM-100</b>	8AO	<b>430,00 €</b>
bis 8AO1100014	<b>Z-FGLL-LS-And-110</b>	8AO	<b>286,00 €</b>	bis 8AO1100012	<b>Z-FGLL-LS-ZM-110</b>	8AO	<b>430,00 €</b>
8AO1110014	<b>Z-FGLL-LS-And-111</b>	8AO	<b>298,00 €</b>	über 8AO1100012	<b>Z-FGLL-LS-ZM-110</b>	8AO	<b>446,00 €</b>
bis 8AO1200014	<b>Z-FGLL-LS-And-120</b>	8AO	<b>298,00 €</b>	bis 8AO1200012	<b>Z-FGLL-LS-ZM-120</b>	8AO	<b>446,00 €</b>
8AO1210014	<b>Z-FGLL-LS-And-121</b>	8AO	<b>320,00 €</b>	über 8AO1200012	<b>Z-FGLL-LS-ZM-120</b>	8AO	<b>480,00 €</b>
bis 8AO1350014	<b>Z-FGLL-LS-And-135</b>	8AO	<b>320,00 €</b>	bis 8AO1350012	<b>Z-FGLL-LS-ZM-135</b>	8AO	<b>480,00 €</b>
8AO1360014	<b>Z-FGLL-LS-And-136</b>	8AO	<b>338,00 €</b>	über 8AO1200012	<b>Z-FGLL-LS-ZM-135</b>	8AO	<b>506,00 €</b>
bis 8AO1500014	<b>Z-FGLL-LS-And-150</b>	8AO	<b>338,00 €</b>	bis 8AO1500012	<b>Z-FGLL-LS-ZM-150</b>	8AO	<b>506,00 €</b>
8AO1510014	<b>Z-FGLL-LS-And-151</b>	8AO	<b>356,00 €</b>	über 8AO1500012	<b>Z-FGLL-LS-ZM-150</b>	8AO	<b>532,00 €</b>
bis 8AO1650014	<b>Z-FGLL-LS-And-165</b>	8AO	<b>356,00 €</b>	bis 8AO1650012	<b>Z-FGLL-LS-ZM-165</b>	8AO	<b>532,00 €</b>
8AO1660014	<b>Z-FGLL-LS-And-166</b>	8AO	<b>378,00 €</b>	über 8AO1650012	<b>Z-FGLL-LS-ZM-165</b>	8AO	<b>566,00 €</b>
bis 8AO1800014	<b>Z-FGLL-LS-And-180</b>	8AO	<b>378,00 €</b>	bis 8AO1800012	<b>Z-FGLL-LS-ZM-180</b>	8AO	<b>566,00 €</b>
8AO1810014	<b>Z-FGLL-LS-And-181</b>	8AO	<b>418,00 €</b>	über 8AO1800012	<b>Z-FGLL-LS-ZM-180</b>	8AO	<b>626,00 €</b>
bis 8AO2000014	<b>Z-FGLL-LS-And-200</b>	8AO	<b>418,00 €</b>	bis 8AO2000012	<b>Z-FGLL-LS-ZM-200</b>	8AO	<b>626,00 €</b>
8AO2010014	<b>Z-FGLL-LS-And-201</b>	8AO	<b>458,00 €</b>	über 8AO2000012	<b>Z-FGLL-LS-ZM-200</b>	8AO	<b>686,00 €</b>
bis 8AO2200014	<b>Z-FGLL-LS-And-220</b>	8AO	<b>458,00 €</b>	bis 8AO2200012	<b>Z-FGLL-LS-ZM-220</b>	8AO	<b>686,00 €</b>

ANr.	Beschreibung	AGr.	Einzelpreis	ANr.	Beschreibung	AGr.	Einzelpreis
<b>Flache Gutlochlehren zum Lehren des I-Ø, ohne ZM</b>				<b>Flache Gutlochlehren zum Lehren des I-Ø, mit ZM</b>			
8AO2210014 bis 8AO2400014	<b>Z-FGLL-LS-And-221</b> <b>Z-FGLL-LS-And-240</b>	8AO 8AO	<b>486,00 €</b> <b>486,00 €</b>	über 8AO2200012 bis 8AO2400012	<b>Z-FGLL-LS-ZM-220</b> <b>Z-FGLL-LS-ZM-240</b>	8AO 8AO	<b>730,00 €</b> <b>730,00 €</b>
8AO2410014 bis 8AO2600014	<b>Z-FGLL-LS-And-241</b> <b>Z-FGLL-LS-And-260</b>	8AO 8AO	<b>520,00 €</b> <b>520,00 €</b>	über 8AO2400012 bis 8AO2600012	<b>Z-FGLL-LS-ZM-240</b> <b>Z-FGLL-LS-ZM-260</b>	8AO 8AO	<b>780,00 €</b> <b>780,00 €</b>
8AO2610014 bis 8AO2800014	<b>Z-FGLL-LS-And-261</b> <b>Z-FGLL-LS-And-280</b>	8AO 8AO	<b>560,00 €</b> <b>560,00 €</b>	über 8AO2600012 bis 8AO2800012	<b>Z-FGLL-LS-ZM-260</b> <b>Z-FGLL-LS-ZM-280</b>	8AO 8AO	<b>840,00 €</b> <b>840,00 €</b>
8AO2810014 bis 8AO3000014	<b>Z-FGLL-LS-And-281</b> <b>Z-FGLL-LS-And-300</b>	8AO 8AO	<b>600,00 €</b> <b>600,00 €</b>	über 8AO2800012 bis 8AO3000012	<b>Z-FGLL-LS-ZM-280</b> <b>Z-FGLL-LS-ZM-300</b>	8AO 8AO	<b>900,00 €</b> <b>900,00 €</b>
8AO3010014 bis 8AO3200014	<b>Z-FGLL-LS-And-301</b> <b>Z-FGLL-LS-And-320</b>	8AO 8AO	<b>630,00 €</b> <b>630,00 €</b>	über 8AO3000012 bis 8AO3200012	<b>Z-FGLL-LS-ZM-300</b> <b>Z-FGLL-LS-ZM-320</b>	8AO 8AO	<b>944,00 €</b> <b>944,00 €</b>
8AO3210014 bis 8AO3500014	<b>Z-FGLL-LS-And-321</b> <b>Z-FGLL-LS-And-350</b>	8AO 8AO	<b>670,00 €</b> <b>670,00 €</b>	über 8AO3200012 bis 8AO3500012	<b>Z-FGLL-LS-ZM-320</b> <b>Z-FGLL-LS-ZM-350</b>	8AO 8AO	<b>1.004,00 €</b> <b>1.004,00 €</b>

ANr.	Beschreibung	AGr.	Einzelpreis	ANr.	Beschreibung	AGr.	Einzelpreis
------	--------------	------	-------------	------	--------------	------	-------------

Flache Ausschusslochlehren, LS (Z-FALL-LS)

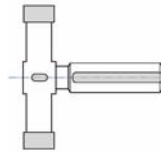

von Nenndurchmesser  
100 bis 200 mm

Flache Ausschusslochlehren zum Lehren des I-Ø, ohne ZM				Flache Ausschusslochlehren zum Lehren des I-Ø, mit ZM			
über 8AP1000014	<b>Z-FALL-LS-And-100</b>	8AP	<b>286,00 €</b>	über 8AP1000012	<b>Z-FALL-LS-ZM-100</b>	8AO	<b>430,00 €</b>
bis 8AP1100014	<b>Z-FALL-LS-And-110</b>	8AP	<b>286,00 €</b>	bis 8AP1100012	<b>Z-FALL-LS-ZM-110</b>	8AO	<b>430,00 €</b>
8AP1110014	<b>Z-FALL-LS-And-111</b>	8AP	<b>298,00 €</b>	über 8AP1100012	<b>Z-FALL-LS-ZM-110</b>	8AO	<b>446,00 €</b>
bis 8AP1200014	<b>Z-FALL-LS-And-120</b>	8AP	<b>298,00 €</b>	bis 8AP1200012	<b>Z-FALL-LS-ZM-120</b>	8AO	<b>446,00 €</b>
8AP1210014	<b>Z-FALL-LS-And-121</b>	8AP	<b>320,00 €</b>	über 8AP1200012	<b>Z-FALL-LS-ZM-120</b>	8AO	<b>480,00 €</b>
bis 8AP1350014	<b>Z-FALL-LS-And-135</b>	8AP	<b>320,00 €</b>	bis 8AP1350012	<b>Z-FALL-LS-ZM-135</b>	8AO	<b>480,00 €</b>
8AP1360014	<b>Z-FALL-LS-And-136</b>	8AP	<b>338,00 €</b>	über 8AP1200012	<b>Z-FALL-LS-ZM-135</b>	8AO	<b>506,00 €</b>
bis 8AOP1500014	<b>Z-FALL-LS-And-150</b>	8AP	<b>338,00 €</b>	bis 8AP1500012	<b>Z-FALL-LS-ZM-150</b>	8AO	<b>506,00 €</b>
8AP1510014	<b>Z-FALL-LS-And-151</b>	8AP	<b>356,00 €</b>	über 8AP1500012	<b>Z-FALL-LS-ZM-150</b>	8AO	<b>532,00 €</b>
bis 8AP1650014	<b>Z-FALL-LS-And-165</b>	8AP	<b>356,00 €</b>	bis 8AP1650012	<b>Z-FALL-LS-ZM-165</b>	8AO	<b>532,00 €</b>
8AP1660014	<b>Z-FALL-LS-And-166</b>	8AP	<b>378,00 €</b>	über 8AP1650012	<b>Z-FALL-LS-ZM-165</b>	8AO	<b>566,00 €</b>
bis 8AP1800014	<b>Z-FALL-LS-And-180</b>	8AP	<b>378,00 €</b>	bis 8AP1800012	<b>Z-FALL-LS-ZM-180</b>	8AO	<b>566,00 €</b>
8AP1810014	<b>Z-FALL-LS-And-181</b>	8AP	<b>418,00 €</b>	über 8AP1800012	<b>Z-FALL-LS-ZM-180</b>	8AO	<b>626,00 €</b>
bis 8AP2000014	<b>Z-FALL-LS-And-200</b>	8AP	<b>418,00 €</b>	bis 8AP2000012	<b>Z-FALL-LS-ZM-200</b>	8AO	<b>626,00 €</b>
8AP2010014	<b>Z-FALL-LS-And-201</b>	8AP	<b>458,00 €</b>	über 8AP2000012	<b>Z-FALL-LS-ZM-200</b>	8AO	<b>686,00 €</b>
bis 8AP2200014	<b>Z-FALL-LS-And-220</b>	8AP	<b>458,00 €</b>	bis 8AP2200012	<b>Z-FALL-LS-ZM-220</b>	8AO	<b>686,00 €</b>



ANr.	Beschreibung	AGr.	Einzelpreis	ANr.	Beschreibung	AGr.	Einzelpreis
<b>Flache Ausschusslochlehren zum Lehren des I-Ø, ohne ZM</b>				<b>Flache Ausschusslochlehren zum Lehren des I-Ø, mit ZM</b>			
8AP2210014 bis 8AP2400014	<b>Z-FALL-LS-And-221</b> <b>Z-FALL-LS-And-240</b>	8AP 8AP	<b>486,00 €</b> <b>486,00 €</b>	über 8AP2200012 bis 8AP2400012	<b>Z-FALL-LS-ZM-220</b> <b>Z-FALL-LS-ZM-240</b>	8AO 8AO	<b>730,00 €</b> <b>730,00 €</b>
8AP2410014 bis 8AP2600014	<b>Z-FALL-LS-And-241</b> <b>Z-FALL-LS-And-260</b>	8AP 8AP	<b>520,00 €</b> <b>520,00 €</b>	über 8AP2400012 bis 8AP2600012	<b>Z-FALL-LS-ZM-240</b> <b>Z-FALL-LS-ZM-260</b>	8AO 8AO	<b>780,00 €</b> <b>780,00 €</b>
8AP2610014 bis 8AP2800014	<b>Z-FALL-LS-And-261</b> <b>Z-FALL-LS-And-280</b>	8AP 8AP	<b>560,00 €</b> <b>560,00 €</b>	über 8AP2600012 bis 8AP2800012	<b>Z-FALL-LS-ZM-260</b> <b>Z-FALL-LS-ZM-280</b>	8AO 8AO	<b>840,00 €</b> <b>840,00 €</b>
8AP2810014 bis 8AP3000014	<b>Z-FALL-LS-And-281</b> <b>Z-FALL-LS-And-300</b>	8AP 8AP	<b>600,00 €</b> <b>600,00 €</b>	über 8AP2800012 bis 8AP3000012	<b>Z-FALL-LS-ZM-280</b> <b>Z-FALL-LS-ZM-300</b>	8AO 8AO	<b>900,00 €</b> <b>900,00 €</b>
8AP3010014 bis 8AP3200014	<b>Z-FALL-LS-And-301</b> <b>Z-FALL-LS-And-320</b>	8AP 8AP	<b>630,00 €</b> <b>630,00 €</b>	über 8AP3000012 bis 8AP3200012	<b>Z-FALL-LS-ZM-300</b> <b>Z-FALL-LS-ZM-320</b>	8AO 8AO	<b>944,00 €</b> <b>944,00 €</b>
8AP3210014 bis 8AP3500014	<b>Z-FALL-LS-And-321</b> <b>Z-FALL-LS-And-350</b>	8AP 8AP	<b>670,00 €</b> <b>670,00 €</b>	über 8AP3200012 bis 8AP3500012	<b>Z-FALL-LS-ZM-320</b> <b>Z-FALL-LS-ZM-350</b>	8AO 8AO	<b>1.004,00 €</b> <b>1.004,00 €</b>

ANr.	Beschreibung	AGr.	Einzelpreis	ANr.	Beschreibung	AGr.	Einzelpreis
------	--------------	------	-------------	------	--------------	------	-------------

**Vierkant-Grenzlehrdorne, LS (Z-4KGLD-LS)**



von Nenndurchmesser  
1 bis 70 mm

Vierkant-Grenzlehrdorne, A-Seite 2 Messfl., ohne ZM				Vierkant-Grenzlehrdorne, A-Seite 2 Messfl., mit ZM			
8AQ0020014	Z-4KGLD-LS-And-2	8AQ	303,00	8AQ0020012	Z-4KGLD-LS-ZM-2	8AQ	394,00
8AQ0030014	Z-4KGLD-LS-And-3	8AQ	290,00	8AQ0030012	Z-4KGLD-LS-ZM-3	8AQ	376,00
8AQ0040014	Z-4KGLD-LS-And-4	8AQ	279,00	8AQ0040012	Z-4KGLD-LS-ZM-4	8AQ	363,00
8AQ0050014	Z-4KGLD-LS-And-5	8AQ	285,00	8AQ0050012	Z-4KGLD-LS-ZM-5	8AQ	370,00
8AQ0060014	Z-4KGLD-LS-And-6	8AQ	290,00	8AQ0060012	Z-4KGLD-LS-ZM-6	8AQ	376,00
8AQ0070014	Z-4KGLD-LS-And-7	8AQ	296,00	8AQ0070012	Z-4KGLD-LS-ZM-7	8AQ	385,00
8AQ0080014	Z-4KGLD-LS-And-8	8AQ	301,00	8AQ0080012	Z-4KGLD-LS-ZM-8	8AQ	391,00
8AQ0090014	Z-4KGLD-LS-And-9	8AQ	308,00	8AQ0090012	Z-4KGLD-LS-ZM-9	8AQ	400,00
8AQ0100014	Z-4KGLD-LS-And-10	8AQ	315,00	8AQ0100012	Z-4KGLD-LS-ZM-10	8AQ	409,00
8AQ0110014	Z-4KGLD-LS-And-11	8AQ	322,00	8AQ0110012	Z-4KGLD-LS-ZM-11	8AQ	418,00
8AQ0120014	Z-4KGLD-LS-And-12	8AQ	328,00	8AQ0120012	Z-4KGLD-LS-ZM-12	8AQ	427,00
8AQ0130014	Z-4KGLD-LS-And-13	8AQ	338,00	8AQ0130012	Z-4KGLD-LS-ZM-13	8AQ	440,00
8AQ0140014	Z-4KGLD-LS-And-14	8AQ	350,00	8AQ0140012	Z-4KGLD-LS-ZM-14	8AQ	455,00
8AQ0150014	Z-4KGLD-LS-And-15	8AQ	367,00	8AQ0150012	Z-4KGLD-LS-ZM-15	8AQ	477,00
8AQ0160014	Z-4KGLD-LS-And-16	8AQ	388,00	8AQ0160012	Z-4KGLD-LS-ZM-16	8AQ	504,00
8AQ0170014	Z-4KGLD-LS-And-17	8AQ	384,00	8AQ0170012	Z-4KGLD-LS-ZM-17	8AQ	499,00
8AQ0180014	Z-4KGLD-LS-And-18	8AQ	394,00	8AQ0180012	Z-4KGLD-LS-ZM-18	8AQ	511,00
8AQ0190014	Z-4KGLD-LS-And-19	8AQ	404,00	8AQ0190012	Z-4KGLD-LS-ZM-19	8AQ	525,00
8AQ0200014	Z-4KGLD-LS-And-20	8AQ	414,00	8AQ0200012	Z-4KGLD-LS-ZM-20	8AQ	538,00
8AQ0210014	Z-4KGLD-LS-And-21	8AQ	444,00	8AQ0210012	Z-4KGLD-LS-ZM-21	8AQ	577,00
8AQ0220014	Z-4KGLD-LS-And-22	8AQ	466,00	8AQ0220012	Z-4KGLD-LS-ZM-22	8AQ	605,00
8AQ0230014	Z-4KGLD-LS-And-23	8AQ	481,00	8AQ0230012	Z-4KGLD-LS-ZM-23	8AQ	625,00
8AQ0240014	Z-4KGLD-LS-And-24	8AQ	488,00	8AQ0240012	Z-4KGLD-LS-ZM-24	8AQ	634,00
8AQ0250014	Z-4KGLD-LS-And-25	8AQ	494,00	8AQ0250012	Z-4KGLD-LS-ZM-25	8AQ	643,00
8AQ0260014	Z-4KGLD-LS-And-26	8AQ	502,00	8AQ0260012	Z-4KGLD-LS-ZM-26	8AQ	652,00
8AQ0270014	Z-4KGLD-LS-And-27	8AQ	510,00	8AQ0270012	Z-4KGLD-LS-ZM-27	8AQ	662,00
8AQ0280014	Z-4KGLD-LS-And-28	8AQ	517,00	8AQ0280012	Z-4KGLD-LS-ZM-28	8AQ	672,00
8AQ0300014	Z-4KGLD-LS-And-30	8AQ	528,00	8AQ0300012	Z-4KGLD-LS-ZM-30	8AQ	687,00
8AQ0320014	Z-4KGLD-LS-And-32	8AQ	535,00	8AQ0320012	Z-4KGLD-LS-ZM-32	8AQ	695,00
8AQ0340014	Z-4KGLD-LS-And-34	8AQ	542,00	8AQ0340012	Z-4KGLD-LS-ZM-34	8AQ	704,00
8AQ0350014	Z-4KGLD-LS-And-35	8AQ	552,00	8AQ0350012	Z-4KGLD-LS-ZM-35	8AQ	717,00
8AQ0360014	Z-4KGLD-LS-And-36	8AQ	565,00	8AQ0360012	Z-4KGLD-LS-ZM-36	8AQ	735,00

ANr.	Beschreibung	AGr.	Einzelpreis	ANr.	Beschreibung	AGr.	Einzelpreis
<b>Vierkant-Grenzlehrdorne, A-Seite 2 Messfl., ohne ZM</b>				<b>Vierkant-Grenzlehrdorne, A-Seite 2 Messfl., mit ZM</b>			
8AQ0380014	<b>Z-4KGLD-LS-And-38</b>	8AQ	<b>581,00</b>	8AQ0380012	<b>Z-4KGLD-LS-ZM-38</b>	8AQ	<b>755,00</b>
8AQ0400014	<b>Z-4KGLD-LS-And-40</b>	8AQ	<b>606,00</b>	8AQ0400012	<b>Z-4KGLD-LS-ZM-40</b>	8AQ	<b>787,00</b>
8AQ0450014	<b>Z-4KGLD-LS-And-45</b>	8AQ	<b>639,00</b>	8AQ0450012	<b>Z-4KGLD-LS-ZM-45</b>	8AQ	<b>831,00</b>
8AQ0500014	<b>Z-4KGLD-LS-And-50</b>	8AQ	<b>680,00</b>	8AQ0500012	<b>Z-4KGLD-LS-ZM-50</b>	8AQ	<b>883,00</b>
8AQ0550014	<b>Z-4KGLD-LS-And-55</b>	8AQ	<b>706,00</b>	8AQ0550012	<b>Z-4KGLD-LS-ZM-55</b>	8AQ	<b>918,00</b>
8AQ0600014	<b>Z-4KGLD-LS-And-60</b>	8AQ	<b>730,00</b>	8AQ0600012	<b>Z-4KGLD-LS-ZM-60</b>	8AQ	<b>949,00</b>
8AQ0650014	<b>Z-4KGLD-LS-And-65</b>	8AQ	<b>754,00</b>	8AQ0650012	<b>Z-4KGLD-LS-ZM-65</b>	8AQ	<b>980,00</b>
8AQ0700014	<b>Z-4KGLD-LS-And-70</b>	8AQ	<b>774,00</b>	8AQ0700012	<b>Z-4KGLD-LS-ZM-70</b>	8AQ	<b>1.006,00</b>

ANr.	Beschreibung	AGr.	Einzelpreis	ANr.	Beschreibung	AGr.	Einzelpreis
------	--------------	------	-------------	------	--------------	------	-------------

**Sechskant-Grenzlehrdorne, LS (Z-6KGLD-LS)**



von Nenndurchmesser  
1 bis 40 mm

Sechskant-Grenzlehrdorne, A-Seite 2 Messfl., ohne ZM				Sechskant-Grenzlehrdorne, A-Seite 2 Messfl., mit ZM			
8AT0030014	Z-6KGLD-LS-And-3	8AT	410,00	8AT0030012	Z-6KGLD-LS-ZM-3	8AT	533,00
8AT0040014	Z-6KGLD-LS-And-4	8AT	397,00	8AT0040012	Z-6KGLD-LS-ZM-4	8AT	515,00
8AT0050014	Z-6KGLD-LS-And-5	8AT	406,00	8AT0050012	Z-6KGLD-LS-ZM-5	8AT	528,00
8AT0060014	Z-6KGLD-LS-And-6	8AT	437,00	8AT0060012	Z-6KGLD-LS-ZM-6	8AT	568,00
8AT0070014	Z-6KGLD-LS-And-7	8AT	451,00	8AT0070012	Z-6KGLD-LS-ZM-7	8AT	586,00
8AT0080014	Z-6KGLD-LS-And-8	8AT	466,00	8AT0080012	Z-6KGLD-LS-ZM-8	8AT	606,00
8AT0090014	Z-6KGLD-LS-And-9	8AT	480,00	8AT0090012	Z-6KGLD-LS-ZM-9	8AT	624,00
8AT0100014	Z-6KGLD-LS-And-10	8AT	502,00	8AT0100012	Z-6KGLD-LS-ZM-10	8AT	652,00
8AT0120014	Z-6KGLD-LS-And-12	8AT	525,00	8AT0120012	Z-6KGLD-LS-ZM-12	8AT	682,00
8AT0140014	Z-6KGLD-LS-And-14	8AT	547,00	8AT0140012	Z-6KGLD-LS-ZM-14	8AT	710,00
8AT0160014	Z-6KGLD-LS-And-16	8AT	568,00	8AT0160012	Z-6KGLD-LS-ZM-16	8AT	739,00
8AT0180014	Z-6KGLD-LS-And-18	8AT	586,00	8AT0180012	Z-6KGLD-LS-ZM-18	8AT	761,00
8AT0200014	Z-6KGLD-LS-And-20	8AT	603,00	8AT0200012	Z-6KGLD-LS-ZM-20	8AT	784,00
8AT0220014	Z-6KGLD-LS-And-22	8AT	619,00	8AT0220012	Z-6KGLD-LS-ZM-22	8AT	804,00
8AT0240014	Z-6KGLD-LS-And-24	8AT	632,00	8AT0240012	Z-6KGLD-LS-ZM-24	8AT	822,00
8AT0260014	Z-6KGLD-LS-And-26	8AT	652,00	8AT0260012	Z-6KGLD-LS-ZM-26	8AT	848,00
8AT0280014	Z-6KGLD-LS-And-28	8AT	787,00	8AT0280012	Z-6KGLD-LS-ZM-28	8AT	1.022,00
8AT0300014	Z-6KGLD-LS-And-30	8AT	814,00	8AT0300012	Z-6KGLD-LS-ZM-30	8AT	1.058,00
8AT0320014	Z-6KGLD-LS-And-32	8AT	847,00	8AT0320012	Z-6KGLD-LS-ZM-32	8AT	1.101,00
8AT0340014	Z-6KGLD-LS-And-34	8AT	874,00	8AT0340012	Z-6KGLD-LS-ZM-34	8AT	1.136,00
8AT0360014	Z-6KGLD-LS-And-36	8AT	903,00	8AT0360012	Z-6KGLD-LS-ZM-36	8AT	1.174,00
8AT0380014	Z-6KGLD-LS-And-38	8AT	938,00	8AT0380012	Z-6KGLD-LS-ZM-38	8AT	1.220,00
8AT0400014	Z-6KGLD-LS-And-40	8AT	964,00	8AT0400012	Z-6KGLD-LS-ZM-40	8AT	1.253,00

ANr.	Beschreibung	AGr.	Einzelpreis	ANr.	Beschreibung	AGr.	Einzelpreis
------	--------------	------	-------------	------	--------------	------	-------------

**Grenzwellennutenlehren, LS (Z-GWNL-LS)**



von Nenndurchmesser  
1 bis 100 mm

Grenzwellennutenlehren (Nutenlehren), ohne ZM				Grenzwellennutenlehren (Nutenlehren), mit ZM			
8AW0010014	<b>Z-GWNL-LS-And-1</b>	8AW	<b>268,00 €</b>	8AW0010012	<b>Z-GWNL-LS-ZM-1</b>	8AW	<b>321,00 €</b>
8AW0020014	<b>Z-GWNL-LS-And-2</b>	8AW	<b>268,00 €</b>	8AW0020012	<b>Z-GWNL-LS-ZM-2</b>	8AW	<b>321,00 €</b>
8AW0030014	<b>Z-GWNL-LS-And-3</b>	8AW	<b>145,00 €</b>	über 8AW0020012	<b>Z-GWNL-LS-ZM-2</b>	8AW	<b>174,00 €</b>
bis 8AW0050014	<b>Z-GWNL-LS-And-5</b>	8AW	<b>145,00 €</b>	bis 8AW0050012	<b>Z-GWNL-LS-ZM-5</b>	8AW	<b>174,00 €</b>
8AW0060014	<b>Z-GWNL-LS-And-6</b>	8AW	<b>131,00 €</b>	über 8AW0050012	<b>Z-GWNL-LS-ZM-5</b>	8AW	<b>158,00 €</b>
bis 8AW0080014	<b>Z-GWNL-LS-And-8</b>	8AW	<b>131,00 €</b>	bis 8AW0080012	<b>Z-GWNL-LS-ZM-8</b>	8AW	<b>158,00 €</b>
8AW0090014	<b>Z-GWNL-LS-And-9</b>	8AW	<b>145,00 €</b>	über 8AW0080012	<b>Z-GWNL-LS-ZM-8</b>	8AW	<b>174,00 €</b>
bis 8AW0120014	<b>Z-GWNL-LS-And-12</b>	8AW	<b>145,00 €</b>	bis 8AW0120012	<b>Z-GWNL-LS-ZM-12</b>	8AW	<b>174,00 €</b>
8AW0130014	<b>Z-GWNL-LS-And-13</b>	8AW	<b>151,00 €</b>	über 8AW0120012	<b>Z-GWNL-LS-ZM-12</b>	8AW	<b>181,00 €</b>
bis 8AW0160014	<b>Z-GWNL-LS-And-16</b>	8AW	<b>151,00 €</b>	bis 8AW0160012	<b>Z-GWNL-LS-ZM-16</b>	8AW	<b>181,00 €</b>
8AW0170014	<b>Z-GWNL-LS-And-17</b>	8AW	<b>162,00 €</b>	über 8AW0160012	<b>Z-GWNL-LS-ZM-16</b>	8AW	<b>194,00 €</b>
bis 8AW0200014	<b>Z-GWNL-LS-And-20</b>	8AW	<b>162,00 €</b>	bis 8AW0200012	<b>Z-GWNL-LS-ZM-20</b>	8AW	<b>194,00 €</b>
8AW0210014	<b>Z-GWNL-LS-And-21</b>	8AW	<b>190,00 €</b>	über 8AW0200012	<b>Z-GWNL-LS-ZM-20</b>	8AW	<b>228,00 €</b>
bis 8AW0250014	<b>Z-GWNL-LS-And-25</b>	8AW	<b>190,00 €</b>	bis 8AW0250012	<b>Z-GWNL-LS-ZM-25</b>	8AW	<b>228,00 €</b>
8AW0260014	<b>Z-GWNL-LS-And-26</b>	8AW	<b>212,00 €</b>	über 8AW0250012	<b>Z-GWNL-LS-ZM-25</b>	8AW	<b>255,00 €</b>
bis 8AW0300014	<b>Z-GWNL-LS-And-30</b>	8AW	<b>212,00 €</b>	bis 8AW0300012	<b>Z-GWNL-LS-ZM-30</b>	8AW	<b>255,00 €</b>
8AW0310014	<b>Z-GWNL-LS-And-31</b>	8AW	<b>251,00 €</b>	über 8AW0300012	<b>Z-GWNL-LS-ZM-30</b>	8AW	<b>301,00 €</b>
bis 8AW0360014	<b>Z-GWNL-LS-And-36</b>	8AW	<b>251,00 €</b>	bis 8AW0360012	<b>Z-GWNL-LS-ZM-36</b>	8AW	<b>301,00 €</b>
8AW0370014	<b>Z-GWNL-LS-And-37</b>	8AW	<b>279,00 €</b>	über 8AW0360012	<b>Z-GWNL-LS-ZM-36</b>	8AW	<b>335,00 €</b>
bis 8AW0450014	<b>Z-GWNL-LS-And-45</b>	8AW	<b>279,00 €</b>	bis 8AW0450012	<b>Z-GWNL-LS-ZM-45</b>	8AW	<b>335,00 €</b>

ANr.	Beschreibung	AGr.	Einzelpreis	ANr.	Beschreibung	AGr.	Einzelpreis
<b>Grenzwellennutenlehren (Nutenlehren), ohne ZM</b>				<b>Grenzwellennutenlehren (Nutenlehren), mit ZM</b>			
8AW0460014 bis 8AW0560014	<b>Z-GWNL-LS-And-46</b> <b>Z-GWNL-LS-And-56</b>	8AW 8AW	<b>307,00 €</b> <b>307,00 €</b>	über 8AW0450012 bis 8AW0560012	<b>Z-GWNL-LS-ZM-45</b> <b>Z-GWNL-LS-ZM-56</b>	8AW 8AW	<b>368,00 €</b> <b>368,00 €</b>
8AW0570014 bis 8AW0700014	<b>Z-GWNL-LS-And-57</b> <b>Z-GWNL-LS-And-70</b>	8AW 8AW	<b>351,00 €</b> <b>351,00 €</b>	über 8AW0560012 bis 8AW0700012	<b>Z-GWNL-LS-ZM-56</b> <b>Z-GWNL-LS-ZM-70</b>	8AW 8AW	<b>422,00 €</b> <b>422,00 €</b>
8AW0710014 bis 8AW0900014	<b>Z-GWNL-LS-And-71</b> <b>Z-GWNL-LS-And-90</b>	8AW 8AW	<b>432,00 €</b> <b>432,00 €</b>	über 8AW0700012 bis 8AW0900012	<b>Z-GWNL-LS-ZM-70</b> <b>Z-GWNL-LS-ZM-90</b>	8AW 8AW	<b>519,00 €</b> <b>519,00 €</b>
8AW0910014 bis 8AW1000014	<b>Z-GWNL-LS-And-91</b> <b>Z-GWNL-LS-And-100</b>	8AW 8AW	<b>474,00 €</b> <b>474,00 €</b>	über 8AW0900012 bis 8AW1000012	<b>Z-GWNL-LS-ZM-90</b> <b>Z-GWNL-LS-ZM-100</b>	8AW 8AW	<b>569,00 €</b> <b>569,00 €</b>



ANr.	Beschreibung	AGr.	Einzelpreis	ANr.	Beschreibung	AGr.	Einzelpreis
------	--------------	------	-------------	------	--------------	------	-------------

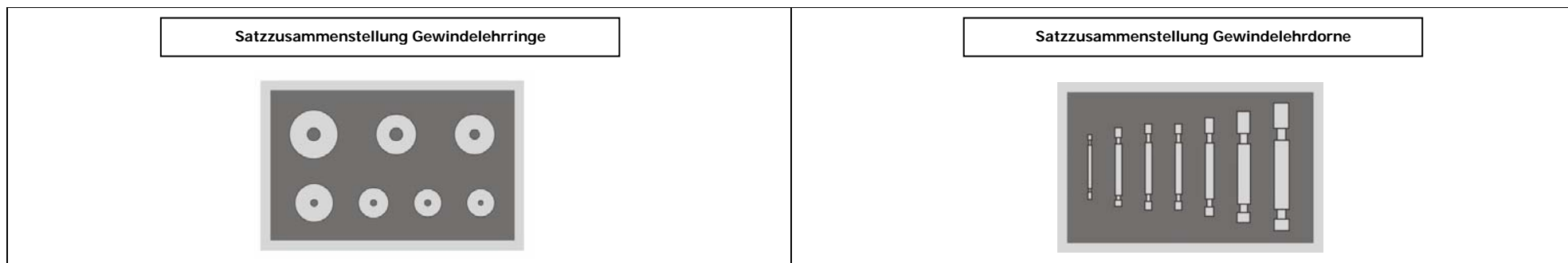

Satzzusammenstellung Gewindelehrringe				Satzzusammenstellung Gewindelehrdorne			
91S0001	GR/AR SATZ M3 BIS M12-6g HOLZETUI	91L	487,00 €	6900010150	GLD SATZ M3 BIS M12-6H HOLZETUI	150L	399,00 €
91S0002	GR/AR SATZ M3 BIS M12-6g-PP HOLZETUI "PP = inkl. Prüfprotokoll"	91S	667,00 €	6900010250	GLD SATZ M3 BIS M12-6G HOLZETUI	150	518,70 €
				6900010350	GLD SATZ M3 BIS M12-6H-PP HOLZETUI "PP = inkl. Prüfprotokoll"	150	559,00 €
				6900010450	GLD SATZ M3 BIS M12-6G-PP HOLZETUI "PP = inkl. Prüfprotokoll"	150	678,70 €

ANr.	Beschreibung	Durchmesser	AGr.	Einzelpreis
------	--------------	-------------	------	-------------

<div style="border: 1px solid black; padding: 10px; width: fit-content; margin: auto;">Prüfprotokolle</div>				
---	--	--	--	--

Prüfprotokolle Gewinde-Grenzlehrdorne				
99000000001	PP-GLD-001003-DEUT	Ø 1 bis 3 mm	99	10,50 €
99000000002	PP-GLD-003020-DEUT	Ø 3 bis 20 mm	99	11,00 €
99000000003	PP-GLD-020060-DEUT	Ø 20 bis 60 mm	99	12,50 €
99000000004	PP-GLD-060100-DEUT	Ø 60 bis 100 mm	99	13,00 €
99000000005	PP-GLD-100150-DEUT	Ø 100 bis 150 mm	99	14,00 €
99000000006	PP-GLD-150200-DEUT	Ø 150 bis 200 mm	99	15,50 €
99000000007	PP-GLD-gr200-DEUT	Ø größer 200 mm	99	16,50 €

Prüfprotokolle Gewinde-Gut-/-Ausschusslehrdorne				
99000000008	PP-GD/AD-001003-DEUT	Ø 1 bis 3 mm	99	6,00 €
99000000009	PP-GD/AD-003020-DEUT	Ø 3 bis 20 mm	99	7,00 €
99000000010	PP-GD/AD-020060-DEUT	Ø 20 bis 60 mm	99	7,50 €
99000000011	PP-GD/AD-060100-DEUT	Ø 60 bis 100 mm	99	8,50 €
99000000012	PP-GD/AD-100150-DEUT	Ø 100 bis 150 mm	99	9,50 €
99000000013	PP-GD/AD-150200-DEUT	Ø 150 bis 200 mm	99	10,00 €
99000000014	PP-GD/AD-gr200-DEUT	Ø größer 200 mm	99	12,50 €

Prüfprotokolle Gewinde-Gut-/-Ausschusslehrringe				
99000000028	PP-GR/AR-001004-DEUT	Ø 1 bis 4 mm	99	6,10 €
99000000029	PP-GR/AR-004040-DEUT	Ø 4 bis 40 mm	99	9,90 €
99000000030	PP-GR/AR-040080-DEUT	Ø 40 bis 80 mm	99	11,50 €
99000000031	PP-GR/AR-080120-DEUT	Ø 80 bis 120 mm	99	12,00 €
99000000032	PP-GR/AR-120200-DEUT	Ø 120 bis 200 mm	99	13,00 €
99000000033	PP-GR/AR-200300-DEUT	Ø 200 bis 300 mm	99	15,50 €

Prüfprotokolle keglige Gewinde-Grenzlehrdorne				
99000000022	PP-GLD-keg-004020-DEUT	Ø 4 bis 20 mm	99	17,50 €
99000000023	PP-GLD-keg-020040-DEUT	Ø 20 bis 40 mm	99	19,50 €
99000000024	PP-GLD-keg-040090-DEUT	Ø 40 bis 90 mm	99	21,50 €

Prüfprotokolle keglige Gewinde-Grenzlehrringe				
99000000025	PP-GLR-keg-004020-DEUT	Ø 4 bis 20 mm	99	20,50 €
99000000026	PP-GLR-keg-020050-DEUT	Ø 20 bis 50 mm	99	25,50 €
99000000027	PP-GLR-keg-050090-DEUT	Ø 50 bis 90 mm	99	29,50 €

ANr.	Beschreibung	Durchmesser	AGr.	Einzelpreis
<b>Prüfprotokolle Grenzlehrdorne, Flache Grenzlochlehren, Vierkant-Grenzlehrdorne, Nutenlehren</b>				
89000000001	PP-Z-GLD-001050-DEUT	1 bis 50 mm	89	5,50 €
89000000002	PP-Z-GLD-050100-DEUT	50 bis 100 mm	89	6,10 €
89000000003	PP-Z-GLD-100150-DEUT	100 bis 150 mm	89	7,20 €
89000000004	PP-Z-GLD-150200-DEUT	150 bis 200 mm	89	8,20 €
89000000005	PP-Z-GLD-200250-DEUT	200 bis 250 mm	89	10,20 €
89000000006	PP-Z-GLD-250300-DEUT	250 bis 300 mm	89	14,50 €
89000000007	PP-Z-GLD-gr300-DEUT	größer 300 mm	89	17,50 €
<b>Prüfprotokolle Gut-/Ausschusslehrdorne, Flache Gut-/Ausschusslochlehren, Vierkant-Gut-/Ausschusslehrdorne</b>				
89000000008	PP-Z-GD/Z-AD-001050-DEUT	1 bis 50 mm	89	4,50 €
89000000009	PP-Z-GD/Z-AD-050100-DEUT	50 bis 100 mm	89	5,10 €
89000000010	PP-Z-GD/Z-AD-100200-DEUT	100 bis 200 mm	89	6,50 €
89000000011	PP-Z-GD/Z-AD-200300-DEUT	200 bis 300 mm	89	9,20 €
89000000012	PP-Z-GD/Z-AD-300500-DEUT	300 bis 500 mm	89	13,50 €
89000000013	PP-Z-GD/Z-AD-5001000-DEUT	500 bis 1000 mm	89	29,00 €
<b>Prüfprotokolle Einstellringe, Lehrringe</b>				
89000000034	PP-Z-ER/Z-GR/Z-AR-0014006-DEUT	Ø 1,4 bis 6 mm	89	9,20 €
89000000035	PP-Z-ER/Z-GR/Z-AR-006050-DEUT	Ø 6 bis 50 mm	89	9,50 €
89000000036	PP-Z-ER/Z-GR/Z-AR-050100-DEUT	Ø 50 bis 100 mm	89	11,20 €
89000000037	PP-Z-ER/Z-GR/Z-AR-100150-DEUT	Ø 100 bis 150 mm	89	11,70 €
89000000038	PP-Z-ER/Z-GR/Z-AR-150200-DEUT	Ø 150 bis 200 mm	89	12,90 €
89000000039	PP-Z-ER/Z-GR/Z-AR-200250-DEUT	Ø 200 bis 250 mm	89	15,90 €
89000000040	PP-Z-ER/Z-GR/Z-AR-250300-DEUT	Ø 250 bis 300 mm	89	17,90 €
89000000041	PP-Z-ER/Z-GR/Z-AR-gr300-DEUT	Ø größer 300 mm	89	25,90 €
<b>Prüfprotokolle Grenzrachenlehren, doppelmäutig</b>				
89000000020	PP-Z-GRLDM-002010-DEUT	Ø 2 bis 10 mm	89	6,20 €
89000000021	PP-Z-GRLDM-010050-DEUT	Ø 10 bis 50 mm	89	6,70 €
89000000022	PP-Z-GRLDM-050100-DEUT	Ø 50 bis 100 mm	89	7,20 €
89000000023	PP-Z-GRLDM-100150-DEUT	Ø 100 bis 150 mm	89	8,20 €
89000000024	PP-Z-GRLDM-150200-DEUT	Ø 150 bis 200 mm	89	9,20 €
89000000025	PP-Z-GRLDM-200250-DEUT	Ø 200 bis 250 mm	89	12,80 €
89000000026	PP-Z-GRLDM-gr250-DEUT	Ø größer 250 mm	89	22,30 €

ANr.	Beschreibung	Durchmesser	AGr.	Einzelpreis
<b>Prüfprotokolle Grenzrachenlehren, einmäulig</b>				
89000000027	PP-Z-GRLEM-002010-DEUT	Ø 2 bis 10 mm	89	6,20 €
89000000028	PP-Z-GRLEM-010050-DEUT	Ø 10 bis 50 mm	89	6,70 €
89000000029	PP-Z-GRLEM-050100-DEUT	Ø 50 bis 100 mm	89	7,20 €
89000000030	PP-Z-GRLEM-100150-DEUT	Ø 100 bis 150 mm	89	8,20 €
89000000031	PP-Z-GRLEM-150200-DEUT	Ø 150 bis 200 mm	89	9,20 €
89000000032	PP-Z-GRLEM-200250-DEUT	Ø 200 bis 250 mm	89	12,80 €
89000000033	PP-Z-GRLEM-gr250-DEUT	Ø größer 250 mm	89	22,25 €
<b>Prüfprotokolle 6kant-Grenzlehrdorne</b>				
89000000043	PP-Z-6KGLD-001050-DEUT	1 bis 50 mm	89	10,20 €